

Appendix E.1 Final Geologic and Soils Engineering Report Part 1



BYER GEOTECHNICAL, INC.

GEOLOGIC AND SOILS ENGINEERING REPORT
RESPONSE TO CITY OF LOS ANGELES CORRECTION LETTER
PROPOSED PARKING STRUCTURE AND PEDESTRIAN BRIDGE
ASSESSOR'S PARCEL NOS. 2385-018-001, -002, -003, AND -011,
2384-007-005, 2385-019-016, -015, -014, -013, 017, -049, -050, AND -051
ARBS. 1 AND 2, FRACTION OF LOT 135, TRACT 6293,
ARBS. 1 AND 2, PORTION OF LOT 1111 AND ARB. 45,
PORTION OF LOT 1112, TRACT 1000, AND
ARBS. 1 AND 2, LOT 65, AND LOTS 63, 64, 66, 67, 68, AND 69, TRACT 7442
3675, 3693, 3703, 3709, 3707, 3717, 3719, 3705, AND 3700 NORTH COLDWATER
CANYON AVENUE,
12908, 12916, 12924, AND 12930 WEST HACIENDA DRIVE, AND
3686 AND 3678 NORTH POTOSI AVENUE
STUDIO CITY, CALIFORNIA
FOR HARVARD-WESTLAKE SCHOOL
BYER GEOTECHNICAL, INC., PROJECT NUMBER BG 21898
MAY 18, 2015

TABLE OF CONTENTS

Introduction	1
Proposed Project	2
Exploration	2
Research	4
Site Description	9
Groundwater	10
Earth Materials	10
Fill	10
Soil/Colluvium	11
Alluvium	11
Bedrock	11
Geologic Structure	12
General Seismic Considerations	12
Regional Faulting	12
Ground Motion	14
Site-Specific Ground Motion Analysis	16
Liquefaction	18
Slope Stability	19
Gross and Seismic Stability	19
Section 1 Calculations	20
Section 5 Calculations	21
Surficial Stability	21
Conclusions and Recommendations	22
General Findings	22
Statement of Responsibility	23
Response to Geology and Soils Report Correction Letter dated April 3, 2013	23
Sequence of Construction	27
Fill Slopes	28
General Grading Specifications	28
Excavation Characteristics	29
Foundation Design	29
General Conditions	29
Spread Footings	30
Deepened Foundations - Friction Piles	31
Lateral Design	31
Foundation Settlement	31

TABLE OF CONTENTS (Continued)

Retaining Walls	32
General Design	32
Backfill	32
Foundation Design	32
Retaining Wall Deflection	33
Freeboard	33
Temporary Excavations	34
Soil-Nail Retaining Walls	34
Soil-Nail Wall Design	35
Soil-Nail Construction	36
Soil-Nail Testing	37
Verification Testing	37
Verification Test Acceptance Criteria	39
Proof Testing	39
Proof Test Acceptance Criteria	40
Soil-Nail Monitoring	41
Floor Slabs	43
Exterior Concrete Decks	43
Asphalt Paving	44
Rigid Paving	44
Drainage	45
Infiltration	45
Waterproofing	46
Plan Review	46
Site Observations during Construction	46
Construction Site Maintenance	47
Appendix I - The J. Byer Group, Inc. (JB 17866-B), excerpts from report dated October 16, 1998	
Laboratory Testing	
Log of Test Pits 1 - 5	
Log of Borings 1 - 5	
Appendix II - Geotechnical Professionals, Inc.	
Report dated July 27, 2010, including	
Direct Shear Test Results	
Log of Boring No. 1 - 10	
Reports dated July 27, 2010, and February 5, 2013, revised February 6, 2013	

TABLE OF CONTENTS (Continued)

Appendix III - The J. Byer Group, Inc. (JB17973-B), excerpts from reports dated February 22 and March 4, 1999

- Laboratory Testing
- Shear Test Diagrams
- Log of Test Pits
- Log of Borings

Appendix IV - Byer Geotechnical, Inc. (BG 21401), excerpts from report dated September 20, 2011

- Log of Borings 1 and 2

Appendix V - Grover Hollingsworth and Associates, Inc., report dated March 25, 2015

Appendix VI - Laboratory Testing, Calculations, and Figures (Current Study)

- Laboratory Testing
- Table I - Moisture/Density
- Shear Diagrams
- Consolidation Diagrams
- Summary of Corrosion Test Results
- USGS Design Maps Summary Report
- Seismic Slope Stability Screening Analysis
- Seismic Sources
- Site-Specific Ground Motion Analysis
- PSH Deaggregation on NEHRP C Soil
- Surficial Stability Calculation
- Passive Earth Pressure Calculation
- Retaining Wall Calculation Sheets
- Temporary Excavation Height Calculation
- Shoring Pile Calculation
- Bearing Capacity Analysis
- Slope Stability Calculations
- Regional Geologic Maps #1 and #2
- Regional Fault Map
- Seismic Hazard Zones Map
- All Earthquakes from 4-24-89 to 5-1-2015, 2.0 & Larger within 32 Km Radius from Site Sections 4, 6, and 8

Appendix VII - DRS Engineering, Inc., Preliminary Permanent Soil Nail Wall Design, dated May 18, 2015

Appendix VIII - KPFF Consulting Engineers, Preliminary City of Los Angeles Low Impact Development (LID) and Hydrology Study, both dated April 10, 2015

Appendix IX - IDG Architects, Sheet A2 - Proposed Site Plan, dated May 18, 2015 (As PDF on CD)

In Pocket: CD - Prior Work
 Geologic Map
 Sections 1, 2, 3, 5, and 7
 Regional Topographic Map

GEOLOGIC AND SOILS ENGINEERING REPORT
RESPONSE TO CITY OF LOS ANGELES CORRECTION LETTER
PROPOSED PARKING STRUCTURE AND PEDESTRIAN BRIDGE
ASSESSOR'S PARCEL NOS. 2385-018-001, -002, -003, AND -011,
2384-007-005, 2385-019-016, -015, -014, -013, 017, -049, -050, AND -051
ARBS. 1 AND 2, FRACTION OF LOT 135, TRACT 6293,
ARBS. 1 AND 2, PORTION OF LOT 1111 AND ARB. 45,
PORTION OF LOT 1112, TRACT 1000, AND
ARBS. 1 AND 2, LOT 65, AND LOTS 63, 64, 66, 67, 68, AND 69, TRACT 7442
3675, 3693, 3703, 3709, 3707, 3717, 3719, 3705, AND 3700 NORTH COLDWATER
CANYON AVENUE,
12908, 12916, 12924, AND 12930 WEST HACIENDA DRIVE, AND
3686 AND 3678 NORTH POTOSI AVENUE
STUDIO CITY, CALIFORNIA
FOR HARVARD-WESTLAKE SCHOOL
BYER GEOTECHNICAL, INC., PROJECT NUMBER BG 21898
MAY 18, 2015

INTRODUCTION

This report summarizes findings of Byer Geotechnical, Inc., Geologic and Soils Engineering Report, including a response to the April 3, 2013, City of Los Angeles, Department of Building and Safety (LADBS), request for additional information. The conclusions and recommendations of this report are intended to provide a safe and stable building site in accordance with the requirements of the City of Los Angeles, Department of Building and Safety (LADBS), Grading Division. The professional opinions and advice presented in this report are based upon our previous work at the site and commonly accepted exploration standards. No warranty is expressed or implied by the issuing of this report.

As part of the preparation of this report, we reviewed the Preliminary Geotechnical Investigation prepared by Geotechnical Professionals, Inc. (GPI), dated July 27, 2010 (the "GPI Report"), and the Update Letter to GPI's July 27, 2010, report dated February 5, 2013, revised February 6, 2013. As stated in Section 1.1 of the GPI Report, the GPI Report was a preliminary report and was not intended as a standalone document for submittal to the City as a final design document. The GPI Report concluded that additional information was required to finalize the detailed design. Now that the design has been finalized and additional testing has been completed based on the final design, the purpose of this report is to provide the additional information necessary so that this report is a standalone document for submittal to the City.

PROPOSED PROJECT

The scope of the proposed project was determined from the preliminary design prepared by IDG Architects, originally dated January 17, 2013, and updated on May 18, 2015 (Updated Site Plan, Sheet A2, enclosed in Appendix IX). The project includes a three-level parking structure with an athletic field on the top level on the west side of Coldwater Canyon and a pedestrian bridge to connect the parking structure to the campus on the east side of Coldwater Canyon Avenue. Permanent soil-nail walls are planned to support excavations into the ascending slope, which will be up to about 87 feet high. The project is diagrammatically shown on the Geologic Map and sections.

EXPLORATION

The subject site was explored by GPI, with respect to the project with the results presented in their July 27, 2010, report and their update letter dated February 5, 2013, revised February 6, 2013 (enclosed). GPI's work included 10 bucket-auger borings. The boring logs are enclosed. The GPI reports were submitted to the LADBS for their review. The City produced the Geology and Soils Report Correction Letter, dated April 3, 2013, which contained 14 requests for additional information. A copy of that letter is enclosed and the requested information is provided in this update report.

The J. Byer Group, Inc. (JBG), previously performed exploration at the subject site on December 22, 23, 28, and 29, 1998, with the aid of a tractor-mounted backhoe, truck-mounted bucket-auger drill rig, and hand labor. It included excavating 11 test pits and drilling six borings to a maximum depth of 43 feet. The JBG findings were provided in their report *Review of Borrow Site Grading Plan, Harvard-Westlake School - West Campus, Portion of Lot 1112, Tract 1000 and Portion of Lot 135, Tract 6293, 3801 Coldwater Canyon Avenue, North Hollywood, California*, dated February 24, 1999. The Shear Test Diagram, Log of Test Pits, and Log of Borings are enclosed and complete report is included on the enclosed CD. The report was reviewed and conditionally approved by the City of Los Angeles, Department of Building and Safety, in their letter dated March 15, 1999 (copy enclosed). Appendix III includes a discussion of the JBG laboratory testing procedures and results.

Byer Geotechnical has reviewed the exploration and laboratory test results presented in the JBG report. The exploration and test results are reasonable for the earth materials encountered. Byer Geotechnical concurs with the test results and accepts responsibility for their use with respect to the proposed project.

Most recently, the site was explored by the firm Grover-Hollingsworth and Associates, Inc. (GH), in conjunction with Byer Geotechnical. Their report *Subsurface Exploration and Laboratory Test Results, Proposed Parking Structure Retaining Walls and Pedestrian Bridge; Arbs 1 and 2, Lot 1111, and Arb 45, Lot 112, Tract 1000, and Arbs 1 and 2, Fraction of Lot 135, Tract 6293; 3700 through 3801 N. Coldwater Canyon Avenue, Studio City, California*, dated March 25, 2015, is enclosed in Appendix V. This work included drilling eight bucket-auger borings and three hand labor test pits, conducted between September 29 and October 7, 2014. Numerous samples were obtained for laboratory testing. The boring and test pit logs, and the results of GH's laboratory testing are enclosed in Appendix V. Byer Geotechnical also obtained samples from their Borings 1 through 7. The Byer Geotechnical test results are included in Appendix VI.

RESEARCH

LADBS records contain the following geotechnical reports, which were prepared for the buildings on the east side of the campus. Copies of the reports and review letters are provided on the enclosed CD (PDF format), with the exception of the Ray A. Eastman report dated May 4, 1996, and Ryland Associates report dated October 10, 1991, which were not available:

Geology and Soils Consultants, Inc.:

Geologic Engineering Investigation, Proposed Library and Field House, 3700 Coldwater Canyon Avenue, Los Angeles, California, dated January 29, 1973; and

Freestanding Retaining Design, Proposed Library-Harvard School, Studio City, California, dated March 6, 1973.

Kovacs-Byer and Associates, Inc.:

Site Exploration, Storage Building, dated January 22, 1974;

Interim Compaction Report, dated February 22, 1974;

Recommendations for Retaining Walls, Vicinity of New Field House, Harvard School, 3700 Coldwater Canyon Avenue, Los Angeles, California, dated March 28, 1979; and

Update of Geologic Engineering Investigation 3700 Coldwater Canyon Avenue, Los Angeles, California, dated November 1, 1978;

Retaining Wall Design Parameters, Harvard School, 3700 Coldwater Canyon Avenue, North Hollywood, California, dated June 14, 1979;

Supplemental Recommendations for Field House Entry Columns, Harvard School, 3700 Coldwater Avenue, Los Angeles, California, dated June 27, 1979;

Pile Inspection, Proposed Fieldhouse and Gymnasium, 3700 Coldwater Canyon Avenue, North Hollywood, California, dated September 18, 1979;

Compaction Report, Foundation Wall Backfill, 3700 Coldwater Canyon Avenue, Los Angeles, California, dated January 10, 1980;

Final Approval on Compaction and Footing Observations, 3700 Coldwater Canyon Avenue, Los Angeles, California, dated May 2, 1980;

Addendum Geologic and Soils Engineering Exploration, Proposed Pool and Pool House, Part of Lot 1111, Tract 1000, 3700 Coldwater Canyon Avenue, North Hollywood, California, dated October 29, 1984;

Basement Wall Recommendations, Proposed Pool House, Part of Lot 1111, Tract 1000, 3700 Coldwater Canyon Avenue, North Hollywood, California, dated January 3, 1985;

Additional Comments, Proposed Pool House, Part of Lot 1111, Tract 1000, 3700 Coldwater Canyon Avenue, North Hollywood, California, dated February 1, 1985;

Additional Comments, Proposed Retaining Wall Design, Part of Lot 1111, Tract 1000, 3700 Coldwater Canyon Avenue, North Hollywood, California, dated June 17, 1985;

Additional Recommendations, Proposed Pool Design, Part of Lot 1111, Tract 1000, 3700 Coldwater Canyon Avenue, North Hollywood, California, dated July 10, 1985; and

Compaction Report, Retaining Wall South of New Pool and Parking Area, 3700 Coldwater Canyon Avenue, North Hollywood, California, dated August 19, 1985.

Foundation Engineering Company:

Soils Engineering Investigation, Hillside Building Site, Harvard School, 3700 Coldwater Canyon Road, Studio City, dated August 23, 1965; and

Report on Controlled Compacted Fill, 3700 Coldwater Canyon Avenue, Studio City, California, dated November 5, 1965.

Ryland Associates, Inc.:

Geologic Investigation, Proposed Benching, dated October 10, 1991.

NorCal Engineering:

Laboratory Tests, letters dated January 7, 1991, November 7, 1991, November 14, 1991, and April 17, 1996.

Epsilon Engineering & Inspection, Inc.:

Report of Preliminary Soil Investigation for Harvard School, Upper Level, 3700 Coldwater Canyon, North Hollywood, California, dated January 10, 1991;

Addenda, dated April 24, 1991, May 23, 1991, and November 6, 1991;

Addenda, dated May 9, 1996, May 20, 1996, and February 13, 1997; and

Report of Preliminary Soil Investigation, Harvard School, Gallery Basement, 3700 Coldwater Canyon, North Hollywood, California, dated March 14, 1997.

LeRoy Crandall and Associates:

Inspection of Caisson Excavations, Proposed Subsurface Drainage System, Inspection of Foundation Excavations and Inspection and Testing of Compacted Fill, Proposed Lower School Building - Harvard School, 3700 Coldwater Canyon Drive, Los Angeles, California, dated November 17, 1967;

Report of Soil Investigation, Proposed Additions to Headmaster's Residence, dated May 12, 1969;

Inspection of Testing of Compacted Backfill, dated July 30, 1968;

Review of Foundation Recommendations, Proposed Academic Center, 3700 Coldwater Canyon Drive, Los Angeles, California, dated August 12, 1968;

Proposed Academic Center, 3700 Coldwater Canyon Drive, Los Angeles, California, dated August 12, 1968;

Inspection and Testing of Compacted Backfill, Review of Foundation Recommendations, dated September 19, 1968;

Inspection and Testing of Compacted Backfill, and Inspection of Footing Excavations, Proposed Retaining Wall, 3700 Coldwater Canyon Drive, Studio City District, Los Angeles, California, for the Harvard School, dated December 19, 1968; and

Placement of Rock Backfill, Academic Center, Harvard School, 3700 Coldwater Canyon Avenue, Los Angeles, California, dated December 29, 1969.

Converse Consultants West:

Geotechnical Investigation, Proposed Science Building, Harvard Westlake School, 3700 Coldwater Canyon Avenue, Studio City, California, dated April 22, 1994.

Ray A. Eastman, Engineering Geologist:

Engineering Geologic Investigation Report, dated May 4, 1996; and

Geologic Information Per Proposed 'Gallery,' dated November 26, 1996.

The J. Byer Group, Inc. (JB 17866-B):

Geologic and Soils Engineering Exploration, Proposed Parking Lot Extension and Gymnasium Addition, Portion of Lot 1111, Tract 1000, 3700 Coldwater Canyon Avenue, North Hollywood, California, dated October 16, 1998;

Addendum Report, Proposed Gymnasium Addition, Portion of Lot 1111, Tract 1000, 3700 Coldwater Canyon Avenue, North Hollywood, California, dated October 23, 1998;

Addendum Report, Proposed Placement of New Fill Over Existing Fill, Portion of Lot 1111, Tract 1000, 3700 Coldwater Canyon Avenue, North Hollywood, California, dated January 26, 1999; and

Geotechnical Engineering Exploration, Proposed Sports-Field Lighting, Lot 1111, Tract 1000, 3700 Coldwater Canyon Avenue, Studio City, California, dated October 9, 2006.

The J. Byer Group, Inc. (JB 17973):

Review of Borrow Site Grading Plan, Harvard-Westlake School - West Campus, Portion of Lot 1112, Tract 1000 and Portion of Lot 135, Tract 6293, 3801 Coldwater Canyon Avenue, North Hollywood, California, dated February 24, 1999; and

Geologic and Soils Engineering Exploration, Proposed Athletic Field, Harvard-Westlake School - West Campus, Portion of Lot 1112, Tract 1000; Portion of Lot 135, Tract 6293, 3801 Coldwater Canyon Avenue, Studio City, California, dated March 4, 1999.

Byer Geotechnical, Inc. (BG 21256):

Geologic and Soils Engineering Exploration, Proposed Brendon Kutler Center and Mudd Library Renovation, Arb. 1, Portion of Lot 1111, Tract 1000, 3700 North Coldwater Canyon Avenue, North Hollywood, California, dated December 30, 2010;

Addendum Geologic and Soils Engineering Exploration, Response to City of Los Angeles Correction Letter, Proposed Brendon Kutler Center and Mudd Library Renovation, Arb. 1, Portion of Lot 1111, Tract 1000, 3700 North Coldwater Canyon Avenue, North Hollywood, California, dated October 31, 2011; and

Summary of Friction Pile Excavations, Proposed Mudd Library Renovation, Arb. 1, Portion of Lot 1111, Tract 1000, 3700 North Coldwater Canyon Avenue, North Hollywood, California, dated January 10, 2012.

Byer Geotechnical, Inc. (BG 21401):

Geologic and Soils Engineering Exploration Update, Proposed Pool, Pool House, and Retaining Wall, Harvard-Westlake School, Lot 1111, Tract 1000, 3700 Coldwater Canyon Avenue, Studio City, California, dated September 20, 2011;

Compaction Report, Proposed Swimming Pool and Pool House, Grading Permit # 11030 - 20000 - 05106, Arb. 1, Lot 1111, Tract 1000, 3700 North Coldwater Canyon Avenue, Studio City, California, dated February 29, 2012; and

Final Compaction Report, Swimming Pool and Pool House Wall Backfills, Grading Permit # 11030 - 20000 - 05106, Arb. 1, Lot 1111, Tract 1000, 3700 North Coldwater Canyon Avenue, Studio City, California, dated September 12, 2012.

Geotechnical Professionals, Inc.:

Preliminary Geotechnical Investigation, Proposed Parking Structure, Harvard-Westlake School, 3700 Coldwater Canyon Avenue, North Hollywood, California, dated July 27, 2010; and

Update Letter, Geotechnical Investigation, Proposed Parking Structure, Harvard-Westlake School, 3700 Coldwater Canyon Avenue, Los Angeles, California, dated February 5, 2013, revised February 6, 2013).

Responses by the City of Los Angeles, Department of Building and Safety (LADBS):

Conditional approval letters, August 27, 1965, November 24, 1965, December 19, 1967, August 14, 1968, August 19, 1968, February 20, 1969, July 29, 1969, March 7, 1973, February 14, 1974, December 14, 1984, June 7, 1985, July 9, 1985, July 24, 1985, Log # 24686, dated July 10, 1991, Log # 26755, dated December 13, 1991, Log # 36331, dated June 29, 1994, Log # 18509, dated July 26, 1996, Log # 20286, dated January 21, 1997, Log # 20634, dated March 21, 1997, Log # 22010, dated August 11, 1997, Log # 26646, dated February 2, 1999, Log # 27226, dated March 15, 1999, and Log # 27150, dated March 18, 1999;

Compaction report approval for primary structural fill, dated January 31, 1980, and August 27, 1985;

Geology/Soil Report Approval Letter, Log # 56969, dated January 23, 2007;

Geology and Soils Report Approval Letter, Log # 75188, dated October 28, 2011;

Compaction Report Approval List for Primary Structural Fill, Log # 76604, dated March 8, 2012;

Conditional approval letter for secondary structural fill, Log # 78400, dated September 20, 2012; and

Geology and Soils Report Correction Letter, Log # 79736, dated April 3, 2013.

The data contained in these reports was reviewed and considered as part of our work on this project.

SITE DESCRIPTION

The subject site consists of multiple contiguous parcels located on the west side of Coldwater Canyon Avenue, approximately one-quarter of a mile south of Ventura Boulevard on the north flank of the Santa Monica Mountains in the Studio City section of the city of Los Angeles, California. The subject site also includes a portion of the campus on the east side of Coldwater Canyon Avenue. Past grading has consisted of cut-and-fill operations to create several level pads. The pads are accessed via a concrete-paved driveway and an unpaved driveway that ascend west from Coldwater Canyon Avenue. Four pads each formerly supported a residence, which have been removed. A north pad was created by placing compacted fill in a secondary canyon. A 2:1 compacted-fill slope descends to the east below the pad to a retaining wall above the concrete driveway. The slope to the west of the north pad ascends offsite, at gradients ranging from 2:1 to 3:1, to a north-trending ridge. The pad south of the north pad was created by cutting into an existing secondary ridge and placing compacted fill to the southeast. Six- to eight-foot-high vertical cuts were created on the west portion of the pad. Slopes ascend offsite to the west and southwest about 350 feet at a 2:1 to a 1½:1 gradient and locally as steep as 1:1.

Vegetation on the pads and cut-and-fill slope consists of scattered weeds and shrubs. Moderate to dense native vegetation is present on non-graded slopes. Surface drainage is by sheetflow runoff down the contours of the land to the two canyons and to the east to Coldwater Canyon Avenue.

GROUNDWATER

Groundwater was not encountered in the six borings by JBG to a maximum depth of 43 feet, the 10 borings by GPI to maximum depth of 71 feet, and the eight borings by GH to a maximum depth of 76 feet. Across Coldwater Canyon Avenue, Byer Geotechnical encountered groundwater in Boring B-1, for the recently-constructed pool, at 29 feet below grade. Seasonal fluctuations in groundwater levels occur due to variations in climate, irrigation, development, and other factors not evident at the time of the exploration. Groundwater levels may also differ across the site.

The bedrock that underlies the east and west flanks of Coldwater Canyon is not a permeable bedrock formation. The campus to the east is within Coldwater Canyon, which drains a large tributary area from Mulholland Drive north. Drainage from the slopes to the south has collected in the alluvium within Coldwater Canyon. Since the bedrock is relatively impermeable, the water remains perched near the bedrock surface on the east side of Coldwater Canyon. Therefore, the groundwater level on the east and west sides of Coldwater Canyon differ. Groundwater in Coldwater Canyon flows northerly out to the alluvium of the San Fernando Valley.

EARTH MATERIALS

Fill

Compacted fill, associated with previous site grading in the north and west-central portions of the site, was observed to be up to 20 feet deep in JBG Boring 3. The compacted fill consists of sandy silt, which is light brownish-gray to dark grayish-brown, slightly moist to moist, firm to very firm, with rock fragments up to six inches.

Uncertified fill, associated with past grading in the south portion of the site is up to eight feet thick in the borings and consists of sandy silt, which is dark gray-brown, slightly moist, medium firm, with brick and concrete fragments.

Soil/Colluvium

Natural residual soil and colluvial soil, termed colluvium, blankets the ascending slopes. The soil and colluvium consist of sandy silt and gravelly silt, which is medium to dark brown to gray-brown, slightly moist, soft to firm, porous with rock fragments up to four inches. The soil and colluvial layers observed are on the order of two to four feet thick.

Alluvium

Natural alluvium has accumulated in the secondary drainage courses that cross the north and south portions of the site. The alluvium was observed to be 6 to 32 feet thick in the borings by JBG, GPI, and GH, and is anticipated to thicken toward the east. On the east side of Coldwater Canyon Avenue, the alluvium is 19 to 31 feet deep in the JBG and KBA borings. The alluvium consists of sandy silt, silt and gravelly silt, which is brown, dark brown, and gray to dark gray-brown, soft to firm, slightly moist to moist, porous to very porous, with roots up to 1½ inches and rock fragments up to six inches.

Bedrock

Bedrock underlying the site and encountered in the test pits and borings consists of diatomaceous siltstone and shale mapped as part of the upper member of the Modelo Formation by H. W. Hoots in the United States Geological Survey Professional Paper 165, *Geology of the Eastern Part of the Santa Monica Mountains, Los Angeles County, California*, 1931. The bedrock is also exposed in cut slopes on the central and west portions of the site.

The bedrock underlying the project is broken into two units. The northern two-thirds of the site is underlain by diatomaceous siltstone and shale that is generally white to tan, thinly bedded, and hard and competent. The dry density of this unit is particularly low. The southern one-third of the site is underlain by siltstone and shale that is diatomaceous, but contains more silt and clay, resulting in a slightly darker grayish-green color, and an average dry density of about 10 pounds-per-cubic-foot

higher. The higher silt and clay content results in lower shear strength. Also, this unit contains some secondary gypsum, a sulfate mineral.

GEOLOGIC STRUCTURE

The bedrock described is common to this area of the Santa Monica Mountains and the geologic structure is consistent with regional trends. Bedding planes mapped generally strike east-west and dip steeply to the north. Bedding is overturned in the southernmost portion of the site, dipping steeply to the south. The geologic structure of the bedrock with steep dips and east-west strike orientation is favorably oriented for stability of the site and proposed project. The bedding will not surcharge the proposed excavations or soil-nail walls. Joint planes mapped are generally randomly oriented and steeply dipping.

The GH Boring 3 encountered several shear and joint planes dipping to the north, as described in the Log of Borehole GH-B3. These structural features have been utilized in the stability calculations and design of the north-facing soil-nail walls.

GENERAL SEISMIC CONSIDERATIONS

Regional Faulting

The subject site is located in Southern California, an active seismic region. Moderate to strong earthquakes can occur on numerous faults located in Southern California. Faults are classified as "active" or "potentially active." Faults from past geologic periods of mountain building that do not display evidence of recent offset are considered "potentially active." Faults that have historically produced earthquakes or show evidence of movement within the past 11,000 years are known as "active faults."

The seismicity of southern California does pose certain hazards to all development projects throughout the Southern California region. One potential hazard is surface rupture from active faults

that may be under a structure. The California Geological Survey has mapped, classified, and zoned active faults in southern California. The active faults and significant other faults are shown in relation to the subject property on the enclosed Regional Fault Map, based on the CGS publication *Fault Activity Map of California*, 2010. In addition, following the damaging 1971 San Fernando earthquake, the CGS has issued maps showing active faults and delineating adjacent areas as Alquist-Priolo Earthquake Fault Zones requiring geologic study to determine the risk of surface rupture to a future structure. The proposed project is located within the USGS Beverly Hills Quadrangle. The only A-P Zones shown on Beverly Hills Quadrangle are in the Baldwin Hills, associated with the Newport-Inglewood Fault, about eight miles south of the site.

It should be noted that CGS has recently updated the adjacent quadrangle to the southeast, the Hollywood Quadrangle, to show an Alquist-Priolo zone around the Hollywood Fault, in which geologic studies are now required to determine the risk of surface rupture to a future structure. The surface trace of the Hollywood Fault is mapped 3¼ miles to the south of the project. The CGS Fault Activity Map shows an unnamed possible fault in North Hollywood, about two miles north of the site.

The Benedict Canyon Fault is an ancient inactive fault that crosses the Santa Monica Mountains about three-quarters of a mile south of the site. The Benedict Canyon Fault poses no hazard to the project.

In conclusion, there is no potential for surface rupture from an earthquake to affect the proposed structures, given the distance to the nearest fault.

The seismic hazard affecting all properties in southern California, including the proposed project, is strong ground shaking as a result of an earthquake. The USGS Earthquake Hazards Program catalogues earthquakes around the world. An archive search was performed for all earthquakes of a magnitude 2.0 or greater over the last 25 years (April 24, 1989, to April 2015) and within a 32-kilometer (19.2-mile) radius of the subject site. This timeframe includes the significant 1994 Northridge Earthquake centered under the San Fernando Valley and M4 earthquakes under the

Sepulveda Pass on March 17, 2014 (4.4), and June 2, 2014 (4.2). One thousand seventeen events were generated by the search and the epicenters are shown on the enclosed exhibit titled "All Earthquakes from 4-24-89 to 5-1-2014 2.0 & Larger within 32 Km Radius [19.2 miles] from Site" (Appendix VI). The closest event is 1.5 miles southeast of the subject site.

In conclusion, the proposed project will be subject to strong ground shaking in the event of a significant local earthquake. Recommendations for design of the structure to resist the ground shaking are presented in the following sections.

The last category of seismic hazards are potential ground deformations resulting from strong ground shaking, such as liquefaction and earthquake-induced landsliding. The CGS has issued a map indicating liquefaction and earthquake-induced landsliding for the Van Nuys Quadrangle, which includes the subject property (see enclosed Seismic Hazard Zones Map). The easternmost portion of the parking structure and most of the pedestrian bridge are to be located in a zone of required investigation for liquefaction. A discussion of the liquefaction potential is included on page 18. The slopes ascending above the project to the west and southwest are located in a Zone of Requested Investigation for earthquake-induced landsliding. Slope stability analyses evaluating the potential for seismic landsliding are discussed on page 19.

Ground Motion

The known regional local faults that could produce the most significant ground shaking at the site include the Hollywood, Santa Monica, Verdugo, Newport-Inglewood, and Malibu Coast Faults. Forty-nine faults were found within a 100-kilometer (62.14-mile) radius search area from the subject site using EZ-Frisk V7.62 computer program. The nearest known "potentially active" fault is the Hollywood Fault, a Type B fault, located 5.4 kilometers (3.4 miles) south of the site. The San Andreas Fault, the nearest Type A fault, is located 53.2 kilometers (33 miles) northeast of the site. General locations of regional active faults with respect to the subject site are shown on the enclosed Regional Fault Map.

Probabilistic seismic hazard deaggregation analysis was performed for the subject site. Seismic parameters were determined using currently available earthquake and fault information, utilizing data from the United States Geological Survey (USGS) National Seismic Hazard Mapping Project (USGS, 2008). An averaging of three Next Generation Attenuation relations (Chiou-Youngs, 2008; Boore-Atkinson, 2008; and Campbell-Bozorgnia, 2008) was incorporated in the analysis. A shear wave velocity (V_{s30}) of 560 meters-per-second (Site Class C) was assumed in the analysis. Hazard deaggregation indicates a predominant mean earthquake magnitude of 6.69 (M_w) at a mean distance of 11.3 kilometers. The probabilistic Peak Horizontal Ground Acceleration (PHGA) with 10-percent probability of exceedance in 50 years is estimated to be 0.49g on the subject site. Results of deaggregation analysis are shown on the enclosed Seismic Hazard Deaggregation Chart (Appendix VI).

The following table lists the seismic coefficients for the project for the 2014 City of Los Angeles Building Code:

SEISMIC COEFFICIENTS (2014 City of Los Angeles Building Code - Based on ASCE 7-10 Standard)		
Latitude = 34.1388° N Longitude = 118.4140° W	Short Period (0.2s)	One-Second Period
Earth Materials and Site Class from Table 20.3-1, ASCE Standard 7-10	Very Dense Soil and Soft Rock - C	
Mapped Spectral Accelerations from Figures 1613.3.1 (1) and 1613.3.1 (2) and USGS	$S_s = 2.374$ (g)	$S_1 = 0.825$ (g)
Site Coefficients from Tables 1613.3.3 (1) and 1613.3.3 (2) and USGS	$F_A = 1.0$	$F_V = 1.3$
Maximum Considered Spectral Response Accelerations from Equations 16-37 and 16-38, 2013 CBC	$S_{MS} = 2.374$ (g)	$S_{M1} = 1.073$ (g)
Design Spectral Response Accelerations from Equations 16-39 and 16-40, 2013 CBC	$S_{DS} = 1.583$ (g)	$S_{D1} = 0.715$ (g)
Maximum Considered Earthquake Geometric Mean (MCE_G) Peak Ground Acceleration, adjusted for Site Class effects	$PGA_M = 0.874$ (g)	

Reference: U.S. Geological Survey, **Earthquake Hazards Program, Seismic Design Values for Buildings**, <http://earthquake.usgs.gov/designmaps/us/application.php>

The mapped spectral response acceleration parameter for the site for a 1-second period (S_1) is greater than 0.75g. Therefore, the project is considered to be in Seismic Design Category E.

The ground motion for the project site is defined by the peak ground acceleration (PGA), the predominant earthquake magnitude (M_w), and the distance to the seismic source. The peak ground acceleration (PGA) is defined as two-thirds of the PGA_M , listed above, and is equal to 0.583g.

The predominant earthquake magnitude and the distance to the seismic source were determined from a probabilistic seismic deaggregation analysis, using the USGS 2008 Interactive Deaggregation application available online (<http://geohazards.usgs.gov/deaggint/2008/>) for a 10 percent probability of exceedance in 50 years (475-year return period), and using a shear-wave velocity estimate of 580 meters per second. The results are shown on the enclosed "PSH Deaggregation on NEHRP CD Soil." The analysis indicates a modal earthquake magnitude (M_w) of 6.58, and a mean fault distance of 5.8 kilometers.

The principal seismic hazard to the proposed project is strong ground shaking from earthquakes produced by local faults. Modern, well-constructed buildings are designed to resist ground shaking through the use of shear panels, moment frames, and reinforcement. Additional precautions may be taken, including strapping water heaters and securing furniture to walls and floors. It is likely that the subject property will be shaken by future earthquakes produced in southern California.

Site-Specific Ground Motion Analysis

Site-specific ground motion analysis was performed in accordance with Chapter 21 of American Society of Civil Engineers (ASCE) Standard 7-10. The probabilistic and deterministic seismic response spectra, based on maximum rotated component of spectral response at five-percent damping, are enclosed. A computerized program, EZ-FRISK, was used to generate the seismic response spectra. An averaging of three Next Generation Attenuation relations (Chiou-Youngs 2007 NGA USGS 2008 MRC; Boore-Atkinson 2008 NGA USGS 2008 MRC; and Campbell-Bozorgnia 2008 NGA USGS 2008 MRC) was incorporated in both the probabilistic and deterministic analyses to estimate ground motions at the subject site. The deterministic response spectrum was generated

using the 84th percentile of the maximum rotated component of spectral response at five-percent damping. A shear-wave velocity (V_{s30}) of 560 meters-per-second (Site Class C) was used in the analysis.

The design response spectrum was generated by multiplying the lesser of the deterministic and probabilistic response spectra by two-thirds, according to Sections 21.2.3 and 21.3 of ASCE Standard 7-10. The deterministic lower limit response spectrum was determined according to Section 21.2.2 of the ASCE Standard 7-10. Spectral response accelerations for selected periods are shown in the following table:

Spectral Response Accelerations (g)*									
	Fundamental Period (seconds)								
	0.2	0.3	0.4	0.5	0.6	0.7	0.8	0.9	1.0
Probabilistic MRC	2.461	2.2140	2.015	1.769	1.517	1.344	1.205	1.091	1.001
Probabilistic (ASCE 7-10)	1.5817	1.5827	1.5827	1.43	1.1917	1.0214	0.8938	0.7944	0.715
Deterministic MRC (84 th Percentile)	3.4500	3.2380	2.936	2.654	2.344	2.11	1.897	1.701	1.539
Deterministic Lower Limit on Prob. Response Spectrum	1.5000	1.5000	1.5000	1.5000	1.3	1.114	0.975	0.867	0.78
80% Design Response Spectrum	1.266	1.266	1.266	1.144	0.953	0.817	0.715	0.636	0.572
Site-Specific Design Response Spectrum	1.641	1.476	1.343	1.179	1.011	0.896	0.803	0.727	0.667

* Reference: *American Society of Civil Engineers (ASCE), Minimum Design Loads for Buildings and Other Structures, Standard 7-05, 2005.*

The data included in the table above are plotted and presented in the enclosed Site-Specific Seismic Response Spectra figure (see Appendix VI). Detailed calculations for fundamental periods up to eight seconds are also included in the "Site-Specific Ground Motion Analysis" table (see Appendix VI).

As shown on the Site-Specific Seismic Response Spectra figure, the site-specific design response spectrum is greater than 80 percent of the probabilistic response spectrum. According to Section 21.3 of ASCE Standard 7-10, the design response spectrum shall not be less than 80 percent of the probabilistic response spectrum.

Based on Section 21.4 of the ASCE Standard 7-10, the design earthquake spectral response acceleration parameters at short period, S_{DS} , and at 1-second period, S_{D1} , derived from the site-specific ground motion analysis are 1.641g and 0.667g, respectively.

Liquefaction

The CGS has mapped the eastern portion of the parking structure, and most of the pedestrian bridge, within an area where historic occurrence of liquefaction or geological, geotechnical, and groundwater conditions indicate a potential for permanent ground displacement such that mitigation as defined in Public Resources Code Section 2693 (c) would be required.

The main north-draining canyon now occupied by Coldwater Canyon Avenue and portions of the Harvard-Westlake campus, east of the street, are underlain by alluvium over bedrock, at depth. As described previously, groundwater is present within the alluvium, perched on top of the less-permeable bedrock.

Liquefaction is a process that occurs when saturated alluvium is subjected to repeated strain reversals during an earthquake. The strain reversals cause increased pore water pressure such that the internal pore pressure approaches the overburden stress and the shear strength approaches zero. Liquefied soils may be subject to flow or excessive strain, which may induce settlement. Liquefaction occurs in soils below the groundwater table. Soils commonly subject to liquefaction include loose to medium-dense sand and silty sand. Predominantly fine-grained soils, such as silts and clay, are less susceptible to liquefaction. Bedrock is expected at the parking structure grade for most of the structure. Foundations will be entirely founded into bedrock. The pedestrian bridge, which extends over Coldwater Canyon Avenue to the east, will also be founded in bedrock. In GH-B8, which is located at the northeast corner of the campus entry and Coldwater Canyon Avenue, weathered bedrock was encountered at 12 feet below grade and bedrock was encountered at 18½ feet below grade.

SLOPE STABILITY

Gross and Seismic Stability

Natural slopes ascend west of the proposed project up to 150 feet (see Section 1). Slopes ascend to the southwest of the project up to 350 feet (see Section 2). Slopes ascend to the south of the project about 50 feet to an existing residence (see Section 5). Most of these slopes are included in a seismic hazard zone requiring investigation for earthquake-induced landsliding. The project includes excavation into the slopes to accommodate the structure. The excavations are to be supported by soil-nail wall retaining systems up to approximately 87 feet high. The proposed project soil-nail walls are shown on the Sections 1 - 7 and on the DRS Engineering, Inc., preliminary soil-nail wall plans (enclosed). Appendix VII contains the preliminary slope stability analysis for the soil-nail retaining walls by DRS Engineering, Inc.

Each section showing a soil-nail wall was checked to find the 1.5 factor of safety (fs) plane requested in the LADBS Correction Letter, using Janbu's corrected method and the software program, *Slide 6.0*. For Section 1, a 46-degree plane from the base of the upper soil-nail wall indicates a 1.5 factor of safety. For Section 2, the 1.5 fs plane is 33 degrees. For Section 3, the 1.5 fs plane is 24 degrees. For Section 5, the 1.5 fs plane is 17 degrees. For Section 6, the 1.5 fs plane is 37 degrees. For Sections 4 and 7, all trials indicate a factor of safety of more than 1.5.

Sections 1 and 5 have been utilized to calculate the gross and seismic stability of the slopes to remain above the soil-nail walls and to check potential failures beneath the soil-nail wall systems. The cross sections used are the most critical for the slopes analyzed. The software program *Slide 6.0* by Rocscience, Inc., was utilized. The analyses show that the slopes above and below the soil-nail walls will be grossly and seismically stable with factors of safety in excess of City requirements.

The calculations use the shear tests of samples performed by Grover Hollingsworth and Associates, Inc., and Byer Geotechnical. The enclosed Shear Diagrams (Appendix VI) are compilations of shear test results, as indicated on the diagrams. Previous testing by The J. Byer Group is also utilized for

future compacted fill and soil blanketing the southern-ascending slope and the ridge line to the west (Appendix III). The samples represent the earth materials encountered during exploration.

The shear strengths utilized are summarized in the following table:

Soil Shear Strength		Static Analysis (Ultimate Values)		Seismic Analysis (Peak Values)		Reference
Soil Type	Unit Weight pcf	Cohesion psf	ϕ deg	Cohesion psf	ϕ deg	
Bedrock (southern unit, along shear plane)	115	510*	19.5*	700	23	BG Shear Diagram #5
Bedrock (southern unit)	115	540	36	825	37	BG Shear Diagrams #3 & #4
Bedrock (northern unit)	100	1044	36.5	1196	38	BG Shear Diagrams #1 and #2
Future Compacted Fill	120	400	30	400	30	JBG Appendix III
Alluvium	110	150	30	--	--	BG Shear Diagram #6
Soil (south slope and west ridge line)	100	360	24	--	--	JBG Appendix III

* Residual shear strength

Section 1 Calculations

Section 1 is drawn through the highest soil-nail wall and follows the secondary ridge line offsite and about 150 feet above the top of the soil-nail wall. Stability analyses above the top and underneath the proposed soil-nail walls indicate a factor of safety well over the LADBS requirements. The calculations use the ultimate shear strength of the northern bedrock unit, to be conservative. It should be noted that this shear strength is about the value proposed for the previous grading project in 1999, and accepted by the LADBS.

Seismic calculations were also performed and indicate factors of safety in excess of the LADBS requirements. The peak shear strength values were utilized for seismic calculations. Stability trials through the soil-nail system were performed by DRS Engineering and are included in Appendix VII.

Section 5 Calculations

Section 5 is drawn through the ascending slope to the south and the highest section of the southern soil-nail wall system. To be conservative, continuous weak zones are assumed per the attitudes measured in nearby Boring GH-3. The weak zones use the residual shear strength determined by GH on a sample of a shear zone (see Shear Diagram #5, Appendix IV). The shear strength for other angles was determined by testing by GH and BG. Gross and seismic stability trials were checked above and below the soil-nail walls. The results indicate factors of safety in excess of LADBS requirements. Trials through the soil-nail walls were performed by DRS Engineering and are in Appendix VII.

SURFICIAL STABILITY

Natural slopes ascend above the proposed project to the south, west, and northwest. Also, two canyons flow towards the project. The southern canyon flows are to be collected in a large debris basin. The J. Byer Group, Inc., excavated TP10 on the slope to the south, and samples of the soil were tested for shear strength with the results included in Appendix III. Based on the shear strength of the soil, and the enclosed Surficial Stability Calculations, it is reasonable to conclude the south slope and the ridge line above the west side of the project are surficially stable.

Within the canyon to the northwest, Grover Hollingsworth excavated three test pits on October 2, 2014. Their shear test results for the surficial earth materials in the northwest canyon indicate that slopes steeper than 28 degrees may not be surficially stable. A series of deflection walls are recommended in this canyon to direct flows around the building to the north. The deflection walls should be positioned at 30 degrees from the canyon flow line.

The method of analysis used for the surficial stability calculations is the "parallel seepage model" recommended by the American Society of Civil Engineers and the Building and Safety Advisory Committee (August 16, 1978). The assumptions of this method are: a uniform planar slope; uniform soil density and shear strength; and uniform seepage parallel to the slope. The validity of the analysis depends, in part, on how closely the assumptions model the field conditions.

For surficial deposits overlying natural slopes, it is the opinion of Byer Geotechnical, Inc., that the assumptions of the "parallel seepage model" may not be completely satisfied. Thus, though the calculation shows that the surficial materials on the site are stable with a factor of safety in excess of 1.5, the mitigating measures recommended in the "Conclusions and Recommendations" of this report should be implemented during development of the site.

CONCLUSIONS AND RECOMMENDATIONS

General Findings

The conclusions and recommendations of this exploration are based upon 6 borings and 11 test pits by The J. Byer Group, 10 borings by GPI, 8 borings and 3 test pits by Grover Hollingsworth and Associates, field geologic mapping, research of available records, consultation, years of experience observing similar properties in similar settings and review of the development plans. It is the finding of Byer Geotechnical, Inc., that construction of the proposed project is feasible from a geologic and soils engineering standpoint, provided the advice and recommendations contained in this report are included in the plans and are implemented during construction.

Geotechnical issues affecting the parking garage include thick deposits of compacted fill and alluvium underlying the north portion of the parking garage and thick alluvium under the south portion. The proposed structures will be supported entirely in bedrock. Cast-in-place friction piles will be necessary to support portions of the parking structure in areas underlain by deep fill and alluvium, and to support the eastern side of the pedestrian bridge. The concrete slab in areas

underlain by fill and/or alluvium will be structurally designed to bridge between the piles. These areas are shown on the enclosed sections and Geologic Map.

Statement of Responsibility

Byer Geotechnical was provided a geologic and soils engineering exploration report prepared by Geotechnical Professionals, Inc. (GPI), dated July 27, 2010, Project 2270.I. This report was submitted to the LADBS, who prepared their April 3, 2013, Correction Letter. Grover Hollingsworth and Associates recently performed exploration and laboratory testing, with the results included in Appendix V. Also, The J. Byer Group previously explored the site. The geologic data and laboratory test results contained in the reports by GPI, Grover Hollingsworth and Associates (GH), and The J. Byer Group, Inc. (JBG), have been reviewed. Byer Geotechnical concurs with the boring data and laboratory testing of JBG, GH, and GPI, and agrees to assume geotechnical responsibility for their use with respect to the proposed project. The GPI bedrock shear test results are inconsistent with the numerous JBG, GH, and BG test results.

RESPONSE TO GEOLOGY AND SOILS REPORT CORRECTION LETTER DATED APRIL 3, 2013

The City of Los Angeles reviewed the GPI report and requested additional information with respect to the proposed project. The items requested are listed below, followed by Byer Geotechnical's item-by-item response:

Item 1. *Provide recommendations and revise the plan and cross section for providing the required building setback from the toe of the ascending slope as specified by Code Section 1808.7.1.*

The building setback as currently shown does not comply with the Building Code or the building setback requirements as outlined in the department's latest public information bulletin P/BC 2011-001. Please review the bulletin (available on-line at www.ladbs.org), and revise the geologic map/plan and the geologic cross-section to comply with the Code and the current building setback requirements.

Notes: Please be informed that the Department does not allow a reduction in building setback, for new buildings. The required setback of 15 feet may be partitioned into two levels using two retaining walls, provided the lower retaining wall is located a minimum clearance from the building of 5 feet.

The building clearance from ascending slopes shall be measured horizontally from the face of the building (or from a vertical projection of the building where upper floor/s extend beyond the lower floor) to the toe of the slope, or to the rear-yard wall(s), if any. No part of the structure (including a balcony) shall be located within the building setback area.

Response: A minimum of a 15-foot level setback is planned on the upslope side of the soil-nail wall system to satisfy this requirement. The setback is shown on the enclosed Geologic Map and Sections. In some areas, the setback will be achieved by raising the soil-nail wall a few feet, so that a 15-foot-wide level backfill can be placed.

Item 2. *Provide pseudo-static slope stability analysis in conformance with the most recent version of CGS Special Publication 117 (i.e. SP 117A), Guidelines for Evaluating and Mitigating Seismic Hazards in California (1803.7.2). Notes: (1) Ground motions used to evaluate liquefaction or slope stability shall be obtained based on methods prescribed in the 2011 LABC (refer to 1803.5.12). Ground shaking hazard maps found in previous Seismic Hazard Zone Reports shall no longer be used to estimate ground shaking. (2) The seismic coefficient, k_{eq} , shall be derived based on a displacement of 5 cm where critical slip surfaces intersect stiff improvements, such as buildings or pools, otherwise a maximum displacement of 15 cm may be assumed. (3) A minimum safety factor of 1.0 is required.*

Response: A pseudo-static slope stability analysis has been provided for Sections 1 and 5, as discussed in the "Slope Stability" section of this report (page 19).

Item 3. *Provide recommendations to adequately protect the proposed building for the potential of surficial instability. Note: Page 14 of the report indicates the existing ascending slope do not have the generally accepted factor of safety for surficial stability.*

Response: The debris basin is planned for the south canyon, and a series of deflection walls are planned for the north canyon. These mitigating structures are shown in detail on the enclosed drawings by KPFF Consulting Engineers. The ascending slopes to the south

and the west ridge line are considered to be surficially stable, as described in the "Surficial Stability" section of this report (page 21).

Item 4. *Provide an assessment of the potential for debris accumulation behind the rear retaining walls and adequate protective recommendations.*

Response: The civil engineer has produced a debris control and drainage plan to conform to the code-required protection. The plan is enclosed (Appendix VIII).

Item 5. *Show the tributary drainage/contributing watershed area on a regional topography map and, provide calculations for debris flow control systems within and at the base of concentrated drainage areas, using the minimum design parameters specified in section 7014.3 of the LA City Building Code.*

Note:(a) If such calculations are to be provided by a civil engineer, include the wet-signed original of the civil engineer's report, in the addendum; (b) Protective devices shall be permanent structures designed to either isolate, contain, deflect or channelize any potential debris flows.

Response: Enclosed in Appendix VIII is a copy of the wet-signed civil engineering plan showing the proposed debris basin and site drainage control.

Item 6. *Provide calculations to the lateral earth pressure required to achieve a minimum factor of safety for the proposed walls. The calculations shall consider any potentially adverse bedding conditions that will [be] exposed in the excavations.*

Response: The allowable passive earth pressure of 250 pounds-per-cubic-foot to a maximum 6,000 pounds-per-square-foot will have the minimum required factor of safety, per the enclosed calculations (Appendix VI).

Item 7. *Show location of a plane with a minimum 1.5 factor of safety on the cross-section(s) prior to implementation of soil nails.*

Response: The 1.5 factor of safety planes, prior to the implementation of the soil nails, have been calculated, as requested, and the results are summarized in the "Slope Stability Section" of this report and are shown on the sections.

Item 8. *Provide temporary excavation recommendations and calculations to verify that the proposed excavation will be temporarily stable during soil nail wall/retaining wall construction.*

Response: Temporary excavation recommendations and calculations are provided, as requested (page 33).

Item 9. *Provide elevations to show the location of the proposed soil-nails, including the proof and verification nails. The geological map shall also show the location of 'proof' and 'verification' soil nails.*

Response: The plans by DRS Engineering for the soil nails are enclosed, which include a map and profiles showing the proof and verification soil nails (Appendix VII).

Item 10. *Provide specific recommendations for soil nailing to satisfy the draft document 'Recommended Guidelines for Permanent Soil Nails' dated 08/23/2000 by the California Soil Nail Committee, and 'Manual for Design & Construction Monitoring of Soil Nail Walls', Publication No. FHWA-SA-96-069R, by U.S. Department of Transportation, Federal Highway Administration.*

Response: The soil-nail walls are designed to satisfy the *Recommended Guidelines for Permanent Soil Nails*, dated August 23, 2000, and the *Manual for Design and Construction Monitoring of Soil Nail Walls*, Publication No. FHWA-SA-96-069R, by the U.S. Department of Transportation, Federal Highway Administration.

Item 11. *Provide complete geotechnical recommendations for the soil nail retention system supported by appropriate calculations. Include parameters such as: soil nail diameter, length, spacing of centralizers, horizontal & vertical nail spacing, wall face batter and bearing.*

Response: The complete soil-nail plans, including calculations, by DRS Engineering are enclosed (Appendix VII).

Item 12. *Provide specific recommendations for corrosion protection/monitoring including the recommended design life.*

Response: Corrosion protection is described in the enclosed DRS Engineering plans. Monitoring recommendations are provided in the following sections of this report.

Item 13. *Provide detailed recommendations for instrumentation and monitoring programs and depict the locations on the geologic map. Define the criteria triggering additional monitoring and remedial measures.*

Response: Detailed recommendations for instrumentation and monitoring are contained in the "Soil-Nail Retaining Walls" section of this report (page 33) and in the DRS plans.

Item 14. *The monitoring program shall include but not be limited to installing slope inclinometers behind the wall.*

Response: Acknowledged. Slope indicators will be installed behind the walls at the approximate locations shown on the DRS Engineering plans.

SEQUENCE OF CONSTRUCTION

The southern portion of the western soil-nail-wall system will cross the southern drainage course, where certified compacted fill is proposed to raise the grade so as to create the downhill dam for a debris basin. This area is underlain by up to 31.5 feet of alluvium over bedrock (see Boring GH B-5 and Section 3). The following sequence of construction for this area is recommended.

Prior to construction of the portion of the soil-nail wall across the southern canyon, it is recommended that the certified compacted fill be placed to create the debris basin dam. It is recommended that the future compacted fill be placed on bedrock. Therefore, the thick alluvium will need to be removed prior to placing the compacted fill. Initially, a temporary 1:1 excavation will need to be made in the alluvium to reach the bedrock in the vicinity of the lower soil-nail wall (see Section 3). The east-facing compacted-fill slope will be a temporary slope and may be placed at a 1½:1 gradient. The temporary compacted fill slope should extend at least three feet beyond the proposed soil-nail-wall face. The west-facing compacted-fill slope may be constructed per the grading plan to create the basin.

The fill should be compacted to a minimum of 90 percent of the maximum dry density, per the specifications found on pages 28 and 29 of this report. Once the compacted fill has been completed, the east-facing slope may be excavated in stages to construct the soil-nail wall per the soil-nail plans. A compaction report will be prepared certifying the compacted fill as primary structural compacted fill.

Fill Slopes

Permanent fill slopes should be constructed at a 2:1 gradient or flatter. Temporary fill slopes may be constructed at a 1½:1 gradient. Compacted fill should be benched into bedrock. A keyway is recommended for the permanent debris basin slope. Keyways should be a minimum of 15 feet wide and 2 feet into alluvium and/or bedrock, as measured on the downhill side. Permanent fill slopes shall be overbuilt about two feet and trimmed to expose the compacted inner core. Trackwalking of permanent slopes is not acceptable to Byer Geotechnical.

GENERAL GRADING SPECIFICATIONS

The following guidelines may be used in preparation of the grading plan and job specifications. Byer Geotechnical would appreciate the opportunity of reviewing the grading plans to ensure that these recommendations are included. The grading contractor should be provided with a copy of this report.

- A. Any areas to receive compacted fill, including retaining walls, should be prepared by removing all vegetation, debris, existing uncompacted fill, soil, colluvium, and alluvium. The exposed excavated area should be observed by the soils engineer or geologist prior to placing compacted fill. The exposed grade should be scarified to a depth of six inches, moistened to optimum moisture content, and recompacted to 90 percent of the maximum density.

- B. Fill, consisting of soil approved by the soils engineer, shall be placed in horizontal lifts and compacted in six-inch layers with suitable compaction equipment. The excavated onsite materials are considered satisfactory for reuse in the controlled fills. Any imported fill shall be observed by the soils engineer prior to use in fill areas. Rocks larger than six inches in diameter shall not be used in the fill.
- C. The fill shall be compacted to at least 90 percent of the maximum laboratory density for the material used. The maximum density shall be determined by ASTM D 1557-12 or equivalent.
- D. Field observation and testing shall be performed by the soils engineer during grading to assist the contractor in obtaining the required degree of compaction and the proper moisture content. Where compaction is less than required, additional compactive effort shall be made with adjustment of the moisture content, as necessary, until 90 percent compaction is obtained. One compaction test is required for each 500 cubic yards or two vertical feet of fill placed.

Excavation Characteristics

The test pits and borings did encounter hard, cemented bedrock. Excavation difficulty is a function of the degree of weathering and amount of fracturing within the bedrock. The bedrock generally becomes harder and more difficult to excavate with increasing depth. Hard, cemented layers are also known to occur at random locations and depths and may be encountered during foundation excavation. Should a hard, cemented layer be encountered, coring or the use of jackhammers may be necessary.

FOUNDATION DESIGN

General Conditions

The following foundation recommendations are minimum requirements. The structural engineer may require footings that are deeper, wider, or larger in diameter, depending on the final loads.

Spread Footings

Continuous and/or pad footings may be used to support portions of the proposed parking garage, the entry road retaining walls, and the west side of the pedestrian bridge, provided they are founded in bedrock. Continuous footings should be a minimum of 12 inches in width. Pad footings should be a minimum of 24-inches square. The following chart contains the recommended design parameters.

Bearing Material	Minimum Embedment Depth of Footing (inches)	Vertical Bearing (psf)	Coefficient of Friction	Passive Earth Pressure (pcf)	Maximum Earth Pressure (psf)
Bedrock	12	3,000	0.5	250	6,000

Increases in the bearing value are allowable at a rate of 600 pounds-per-square-foot for each additional foot of footing width or depth to a maximum of 6,000 pounds-per-square-foot. For bearing calculations, the weight of the concrete in the footing may be neglected.

The bearing value shown above is for the total of dead and frequently applied live loads and may be increased by one-third for short duration loading, which includes the effects of wind or seismic forces. When combining passive and friction for lateral resistance, the passive component should be reduced by one-third.

All continuous footings should be reinforced with a minimum of four #4 steel bars; two placed near the top and two near the bottom of the footings. Footings should be cleaned of all loose soil, moistened, free of shrinkage cracks, and approved by the geologist prior to placing forms, steel or concrete.

Deepened Foundations - Friction Piles

Drilled, cast-in-place concrete friction piles are recommended to support portions of the proposed parking structure located over deep fill and alluvium, as shown on the Geologic Map and sections, and the eastern side of the pedestrian bridge. Piles should be a minimum of 24 inches in diameter and a minimum of eight feet into bedrock. Piles may be assumed fixed at three feet into bedrock. The piles may be designed for a skin friction of 700 pounds-per-square-foot for that portion of pile in contact with the bedrock.

Lateral Design

The friction value is for the total of dead and frequently applied live loads and may be increased by one-third for short duration loading, which includes the effects of wind or seismic forces. Resistance to lateral loading may be provided by passive earth pressure within the bedrock.

Passive earth pressure may be computed as an equivalent fluid having a density of 250 pounds-per-cubic-foot for the bedrock. The maximum allowable earth pressure is 6,000 pounds-per-square-foot for the bedrock. For design of isolated piles, the allowable passive and maximum earth pressures may be increased by 100 percent. Piles spaced more than 2½ pile diameters on center may be considered isolated.

Foundation Settlement

Settlement of the foundation system is expected to occur on initial application of loading. A settlement of one-half to one inch may be anticipated. Differential settlement should not exceed one-half of an inch.

RETAINING WALLS

General Design

Conventional retaining walls are planned for the southern entry driveway. Conventional retaining walls up to 12 feet high with a level to 2:1 backslope may be designed for an equivalent fluid pressure of 43 pounds-per-cubic-foot (per the enclosed calculations). No additional force is required for the seismic case. Retaining walls should be provided with a subdrain or weepholes covered with a minimum of 12 inches of ¾-inch crushed gravel.

Backfill

Retaining wall backfill should be compacted to a minimum of 90 percent of the maximum density as determined by ASTM D 1557-12, or equivalent. Where access between the retaining wall and the temporary excavation prevents the use of compaction equipment, retaining walls should be backfilled with ¾-inch crushed gravel to within two feet of the ground surface. Where the area between the wall and the excavation exceeds 18 inches, the gravel must be vibrated or wheel-rolled, and tested for compaction. The upper two feet of backfill above the gravel should consist of a compacted-fill blanket to the surface. Restrained walls should not be backfilled until the restraining system is in place.

Foundation Design

Retaining wall footings may be sized per the following table:

Bearing Material	Minimum Embedment Depth of Footing (Inches)	Vertical Bearing (psf)	Coefficient of Friction	Passive Earth Pressure (pcf)	Maximum Earth Pressure (psf)
Bedrock	12	3,000	0.5	250	6,000

Increases in the bearing value are allowable at a rate of 600 pounds-per-square-foot for each additional foot of footing or depth to a maximum of 6,000 pounds-per-square-foot. For bearing calculations, the weight of the concrete in the footing may be neglected.

The bearing values shown above is for the total of dead and frequently applied live loads and may be increased by one-third for short duration loading, which includes the effects of wind or seismic forces. When combining passive and friction for lateral resistance, the passive component should be reduced by one-third.

Footings should be cleaned of all loose soil, moistened, free of shrinkage cracks, and approved by the geologist prior to placing forms, steel, or concrete.

Retaining Wall Deflection

It should be noted that non-restrained retaining walls can deflect up to one percent of their height in response to loading. This deflection is normal and results in lateral movement and settlement of the backfill toward the wall. The zone of influence is within a 1:1 plane from the bottom of the wall. Hard surfaces or footings placed on the retaining wall backfill should be designed to avoid the effects of differential settlement from this movement. Decking that caps a retaining wall should be provided with a flexible joint to allow for the normal deflection of the retaining wall. Decking that does not cap a retaining wall should not be tied to the wall. The space between the wall and the deck will require periodic caulking to prevent moisture intrusion into the retaining wall backfill.

Freeboard

Retaining walls surcharged by a sloping condition should be provided with a minimum of 12 inches of freeboard for slough protection. An open "V" drain should be placed behind the wall so that all upslope flows are directed around the structure to the street.

Temporary Excavations

Temporary excavations will be required to construct conventional retaining walls for the north entry road and the south exit and service road. The excavations will expose soil over bedrock. The soil should be trimmed to 1:1 for wall excavations. The bedrock is capable of maintaining vertical excavations up to 10 feet per the enclosed calculations. Where vertical excavations in the bedrock exceed 10 feet in height, the upper portion should be trimmed to 1:1 (45 degrees).

Vertical excavations in excess of 10 feet may require the use of temporary shoring. Temporary shoring should be designed for an equivalent fluid pressure of 30 pounds-per-cubic-foot per the enclosed calculations.

Temporary excavations will be also required to construct the soils-nail walls. These excavations should be limited to a vertical height of five feet. Once a soil-nail row is installed and shotcrete is placed, the next five feet may be excavated.

The geologist should be present during grading to see the temporary slopes. All excavations should be stabilized within 30 days of initial excavation. Water should not be allowed to pond on top of the excavations or to flow toward them. No vehicular surcharge should be allowed within three feet of the top of the cut.

SOIL-NAIL RETAINING WALLS

Soil-nail walls have been in use in Europe since the early 1970s and in the USA since the late 1970s. The technique has now been utilized on thousands of projects throughout the USA. Notably, the Federal Highway Administration issued Guideline Publications for Soil-Nail Wall Construction in 1996 and 2003, and the technique has been adopted on major highway projects throughout the USA. In California, the Department of Transportation has developed its own design software and has specified and utilized soil nailing for many interstate widening projects. Following the 1989 Loma

Prieta earthquake, studies were carried out to assess the performance of soil-nail walls in seismic events. The research, to date, indicates soil-nail walls perform excellently in seismic conditions.

The following recommendations apply to the design of the permanent soil-nail walls.

Soil-Nail Wall Design

Soil-nail walls shall be designed in accordance with the California Building Code 2013 Edition, FHWA Geotechnical Engineering Circular No. 7 - Soil-Nail Walls, FHWA 0-IF-03-017 March 2003 and the Recommended Guidelines for Permanent Soil-Nails California Soil Nail Committee, dated 08-23-2000. The following geotechnical parameters are recommended for soil-nail wall design.

Soil Type	Unit Weight (pcf)	Friction Angle (deg)	Cohesion (psf)	Ultimate Bond Stress (psi)
Bedrock (Sections 3 to 7)	110	36.5	1044	16
Bedrock (Sections 1 and 2) Weak Zone	115	19.5	510	16
Bedrock (Sections 1 and 2) Other Areas	115	36	540	16
Fill	120	30	400	12
Alluvium	110	30	150	10

The soil-nail walls should be designed for the slope stability seismic coefficient of $K_h = 0.27g$

Soil-nail walls should be designed such that the global and internal factors of safety are in accordance with the recommendations of the FHWA Geotechnical Engineering Circular No. 7 - Soil-Nail Walls, FHWA 0-IF-03-017 March 2003 and/or the requirements of the LADBS letter (signed by Pascal Challita, Assistant Chief) dated July 16, 2014, regarding pseudo-static slope stability analysis.

Soils nails reinforce the ground in which they are installed, and conventional analysis based upon an equivalent fluid pressure at the soil-nail wall face is not applicable. However, the LADBS requires a check calculation in which it is shown that the soil nails can support an active equivalent fluid pressure (EFP) using only the bond capacity of the soil nails beyond a theoretical active failure zone, which is defined as the failure surface with the lowest factor of safety. The LADBS requested calculations to determine the minimum required EFP applied on the soil-nail-wall face, ignoring the soil-nail resistance, so as to achieve a factor of safety of 1.5 (1.0 for the seismic case). The LADBS also requested calculations to determine the EFP required on the vertical plane on the upslope side of the block of earth containing the soil nails. These calculations were performed to achieve a static factor of safety of 1.5 and a seismic factor of safety of 1.0. These checks are provided for critical Sections 1, 3, 5, and 6.

The calculations are enclosed in Appendix VI. The results are summarized in the following table:

Section	EFP on Wall Face to Achieve 1.5 (pcf)	EFP on Wall Face to Achieve 1.0 (Seismic) (pcf)	EFP on Block of Earth to Achieve 1.5 (pcf)	EFP on Block of Earth to Achieve 1.0 (Seismic) (pcf)
1	10	10	30	30
3	20	20	21	21
5	85	110	67	75
6	16	16	25	25

Soil-Nail Construction

Preliminary plans indicate that a one or two-tier soil-nail wall system will support the excavation to tuck the proposed parking structure into the ascending slope and to create the 15-foot setback from the ascending slope. The soil-nail-wall system will be up to approximately 87 feet high.

The soil-nail walls will be sloped at a ¼:1 gradient and should be supported by multiple rows of soil nails, inclined 15 to 25 degrees below the horizontal. Soil-nail spacing should be as required for stability, but should generally be five feet center-to-center, both vertical and horizontal.

Soil nails should be double-corrosion protects, to be achieved through the use of steel tendons being encapsulated by grout within a high density polyethylene (HPDE) corrugated sleeve.

Soil-nail borehole diameters should generally be in the range of 4 inches to 12 inches.

The soil-nail-grout-sleeve assembly should be installed inside the borehole and minimum grout cover provided by means of spacers located at no more than 10-foot intervals. Final grouting of the borehole should be achieved by the use of a tremie pipe, where grout is introduced at the bottom of the borehole first. Final group should comprise neat water/cement grout with a minimum compressive strength of 3,000 psi at 28 days.

The soil-nail-wall facing should be comprised of a temporary shotcrete facing installed during excavation and a permanent structural facing placed after excavation is complete. The permanent shotcrete facing should be connected to the soil nails via a steel bearing with headed studs.

Drainage behind the soil-nail walls should be provided and should consist of geo-composite drain strips, two feet wide and five feet on center, outletting through a gravel pocket and pipe at the base of the wall.

SOIL-NAIL TESTING

Verification Testing

Two verification test nails shall be installed in each soil strata: the compacted fill, bedrock (north and south) alluvium (Section 6), and compacted future fill. Completion of successful verification tests

is required prior to the installation of production nails in those strata. The nails used for the verification tests shall be sacrificial and shall not be incorporated into the production-nail schedule.

Verification tests shall be performed on sacrificial nails to the ultimate bond stress value. Install the test nails by the same method that is used for production nails, except grout only the bond length specified on the plans. Verification test nails may be plain bar and need not be epoxy coated or encapsulated in HDPE sheathing.

Verification test nails should have a minimum 15-foot bonded length for testing. The maximum test load should be determined based upon the test bond length and the borehole diameter selected such that the maximum grout/ground bond stress at the maximum test load is equal to the ultimate bond stress assumed in the design for the strata in which the test nail is founded. Select the verification test nail bar size, such that the maximum stress in the bar at the maximum test load does not exceed $0.9f_y$.

Verification test nails shall be incrementally loaded to twice the design load and movements recorded in accordance with the following schedule:

Load	Load Hold
al	1 minute
0.25 dl	1 minute
0.50 dl	1 minute
0.75 dl	1 minute
1.00 dl	1 minute
1.25 dl	1 minute
1.50 dl	60 minutes
1.75 dl	1 minute
2.00 dl	1 minute

al = alignment load
dl = nail design load

All load increments shall be maintained within five percent of the intended load. The verification test nail shall be monitored for creep at 1.50 dl load increments. The creep period shall start as soon as the 1.5 dl test load is applied and the nail movement with respect to a fixed reference shall be measured and recorded at 1, 2, 3, 5, 6, 10, 20, 30, 50, and 60 minutes. The verification test nail shall be unloaded in increments of 25 percent, with measurements of deflection at each increment.

Upon successful completion of the verification test, the nail shall be loaded in 25 percent increments. Each load increment shall be held until a stable reading is obtained and the nail extension at the increment recorded. Load shall be increased in 25 percent increments until either constant load results in continuous extension or 90 percent of the yield capacity or 80 percent of the guaranteed ultimate capacity of the bar is reached. The maximum test load achieved and the corresponding bar extension shall be recorded.

Verification Test Acceptance Criteria

For verification tests, if the creep curve indicates a creep rate of less than 0.08 inch per log cycle time, and the rate is linear or decreasing throughout the hold load, the test is successful.

Proof Testing

Proof tests shall be performed on five percent of the soil nails to verify the bond stress value assumed in the design. Nails should be tested on every lift and on different locations along the wall. Proof tests shall be performed using testing equipment calibrated within 60 days of the start of testing.

Proof test nails should have a minimum of 10 feet bonded length for testing. The maximum test load should be determined based upon the test bond length and the hole diameter selected such that the maximum group/ground bond stress at the maximum test load is equal to 150 percent of the allowable bond stress assumed in the design for the strata in which the test nail is bounded.

Proof tests shall be performed on production nails to 150 percent of the allowable bond stress value used in design. Install the proof test nails by the same method that is used for all production nails, except grout only the bond length specified on these plans.

Securely block out the front one foot of the soil-nail hole with loose soil or other flexible material to avoid penetration of shotcrete in the open hole. Perform the proof test by loading the soil nail in the following increments:

Al	al = alignment load
0.25 dl	dl = nail design load
0.50 dl	
0.75 dl	
1.00 dl	
1.50 dl	

All load increments shall be maintained within five percent of the intended load. Depending on the performance, either 10 minute or 60 minute creep tests shall be performed at the maximum test load. The creep period shall start as soon as the maximum test load is applied and the nail movement with respect to a fixed reference shall be measured and recorded at 1 minute, 2, 3, 5, 6, and 10 minutes. Where nail movement between 1 minute and 10 minutes exceeds 0.04 inches, the maximum test load shall be maintained an additional 50 minutes and movements shall be recorded at 20 minutes, 30, 50, and 60 minutes.

Proof Test Acceptance Criteria

If at the proof test load the movement between 1 and 10 minutes is less than 0.04 inch, the test is successful. If the movement exceeds 0.04 inch, the proof test load may be held for an additional 50 minutes and a creep curve shall be plotted for movement between 6 and 60 minutes. If the creep curve indicates a creep rate of less than 0.08 inch per log cycle time, the test is successful.

Soil-Nail Monitoring

The soil-nail wall should be monitored for movement both during construction and after completion of the wall.

Slope inclinometers should be installed upslope and within 10 feet of the soil-nail wall. The slope inclinometers should consist of a 2³/₄-inch-diameter pvc slope-indicator casing installed within an eight-inch diameter drilled shaft. Inclinometer shafts shall be drilled using a hollow-stem-auger drill and backfilled with a 5:1 bentonite to cement slurry after casing installation. The slope inclinometers should extend a minimum of 10 feet below the base of the wall. The recommended location of the slope inclinometers are indicated on the Geologic Map.

Optical survey points at a minimum of 40 feet center-to-center along the top of the wall should be installed along the top of the soil-nail wall prior to excavation, such that the lateral and vertical deformation of the top of the soil-nail wall can be monitored during excavation.

In addition, it is recommended that 20 soil nails be equipped with strain gauges (or other approved load-monitoring system) that will enable regular long-term monitoring of the load within the soil nails after completion of the wall construction. These monitor nails should be distributed through the soil-nail walls. The strain gauges should be located along the nail length, such that the load distribution along the nail length can be determined.

Prior to any construction activities that may affect adjacent properties, a complete existing condition survey should be undertaken to observe and document the pre-construction condition of all structures, infrastructure, sidewalks, roadways, and all other facilities adjacent to the site. Documentation shall be circulated to contractor, engineer, and owner prior to start of excavation.

During the excavation phase, the soil-nail wall shall be inspected daily by visual observation for the signs of ground or building movements in the vicinity of each working front. In addition, the optical

monitoring pints at 40 feet center-to-center along the top of the wall should be monitored no less than once per week during excavation and twice a month thereafter until the permanent wall is completed. Monitoring reports should be circulated to contractor, engineer, and owner within 24 hours of data collection.

Long-term monitoring of the performance of the soil-nail wall may be achieved using the inclinometers installed behind the wall and by recording of the loads within the 20 soil nails equipped with load monitoring devices. Long-term monitoring should be performed at no less than twice per year for the first two years of service life, and no less than once per year for the following five years, and then once every five years thereafter.

During long-term monitoring, should any slope indicator show excessive movement or any load monitoring data show excessive nail loading, the geotechnical engineer and earth retention designer shall be engaged by the owner to analyze the information and make recommendations for any remedial action.

Excessive slope indicator movement is defined as a movement of more than 0.1 inch per month. Excessive nail loading is defined as a nail tensile stress of $> 0.75fy$.

The preliminary design plans for the soil-nail walls prepared by DRS Engineering are enclosed, along with preliminary slope stability calculations that indicate that the current proposed configuration of two retaining walls will be grossly stable with a factor of safety exceeding the requirements of the City of Los Angeles and the Federal Highway Administration.

Byer Geotechnical has reviewed the enclosed DRS Engineering plans and the underlying calculations. A copy of the calculations has been provided for reference. The DRS Engineering plans and underlying calculations conform to the recommendations and design criteria, and are endorsed by Byer Geotechnical. The DRS Engineering plans are considered a part of this report.

FLOOR SLABS

Floor slabs should be cast over bedrock and reinforced with a minimum of #4 bars on 16-inch centers, each way. For areas of deep fill and alluvium, the slabs should be structurally designed to bridge between the piles and grade beams.

Slabs that will be provided with a floor covering should be protected by a polyethylene plastic vapor barrier. The barrier should be sandwiched between the layers of sand, about two inches each, to prevent punctures and aid in the concrete cure. A low-slump concrete may be used to minimize possible curling of the slab. The concrete should be allowed to cure properly before placing vinyl or other moisture-sensitive floor covering.

Prior to the placement of concrete slabs on expansive soils, the subgrade shall be pre-moistened until the moisture content reaches at least 120 percent of the optimum moisture content to a depth of twelve inches. The pre-moistened soils should be tested, and verified to be 120 percent of optimum moisture content, prior to pouring.

It should be noted that cracking of concrete slabs is common. The cracking occurs because concrete shrinks as it cures. Control joints, which are commonly used in exterior decking to control such cracking, are normally not used in interior slabs. The reinforcement recommended above is intended to reduce cracking and its proper placement is critical to the performance of the slab. The minor shrinkage cracks, which often form in interior slabs, generally do not present a problem when carpeting, linoleum, or wood floor coverings are used. The slab cracks can, however, lead to surface cracks in brittle floor coverings such as ceramic tile.

EXTERIOR CONCRETE DECKS

Exterior concrete decking should be cast over bedrock or approved compacted fill placed in accordance with the "General Grading Specifications" section of this report. Decking should be

reinforced with a minimum of #3 bars placed 18 inches on center, each way. Decking that caps a retaining wall should be provided with a flexible joint to allow for the normal one to two percent deflection of the retaining wall. Decking that does not cap a retaining wall should not be tied to the wall. The space between the wall and the deck will require periodic caulking to prevent moisture intrusion into the retaining wall backfill. The subgrade should be moistened prior to placing concrete.

ASPHALT PAVING

Prior to placing asphalt, the existing grade should be scarified to a depth of 12 inches, moistened as required to obtain optimum moisture content, and recompact to 90 percent of the maximum dry density, as determined by ASTM D 1557-12. Trench backfill below paving should be compacted to 90 percent of the maximum dry density. Irrigation water should be prevented from migrating under paving. The following table shows the recommended pavement sections:

Service	Pavement Thickness (Inches)	Base Course (Inches)
Light Passenger Cars	3	4
Moderate Trucks (Storage, etc.)	4	6
Heavy Trucks	6	11

Base course should be crusher-run base (CRB) and compacted to 95 percent of the maximum density.

RIGID PAVING

Rigid paving using reinforced concrete may be used for the road surfaces. The standard section for a utility access road, including fire department access, is six inches of concrete over 11 inches of compacted crusher-run base. The concrete should be reinforced with #4 bars 16 inches on center,

each way. The base course should be compacted to 95 percent of the maximum density. The road section should be placed over an approved bottom, as determined by the geotechnical engineer.

DRAINAGE

Control of site drainage is important for the performance of the proposed project. Pad and roof deck drainage should be collected and transferred to the street in non-erosive drainage devices. Drainage should not be allowed to pond on the pad or against any foundation or retaining wall. Drainage should not be allowed to flow uncontrolled over any descending slope. Planters located within retaining wall backfill should be sealed to prevent moisture intrusion into the backfill. It is the responsibility of the owner to maintain drainage control devices so that they remain effective and operating. Periodic cleaning, testing, and maintenance is necessary to remove any debris that could clog inlets or channels.

The project is planned at the base of two natural drainage courses. The southernmost encompasses approximately seven acres of tributary area. The project civil engineer has designed a debris basin to accommodate this drainage, as shown on the Geologic Map and the KPFF plans. The northernmost drainage controls about four acres of tributary area. This drainage will be directed around the structure to the street in a drainage swale. Velocity reducers will be used to slow the flow and direct it onto Coldwater Canyon Avenue.

Infiltration

Typically, infiltration systems are utilized in areas underlain by pervious granular earth materials that have high percolation characteristics. In addition, infiltration systems are normally planned at least 10 feet from adjacent property lines or public right-of-way, and 15 feet from a 1:1 plane projected from the bottom of adjacent structural foundations. However, the site conditions are not favorable for infiltration pits. They are not recommended for this site.

As an alternative, a flow-through biofiltration system may be installed on the site as permitted by the City of Los Angeles, Best Management Practices (City of Los Angeles, 2011). A planter box may be used to capture and treat storm-water runoff through different soil layers before discharging water to the street or storm drain. Planter boxes should be impermeable. Planter boxes may be situated above ground and placed adjacent to buildings. Planter boxes should be designed as freestanding and for an inward equivalent fluid pressure of 43 pounds-per-cubic-foot. This fluid pressure includes possible vehicular surcharge. Byer Geotechnical, Inc., should be provided with the final plans to verify the location of the planter boxes.

WATERPROOFING

Retaining walls are subject to moisture intrusion, seepage, and leakage and should be waterproofed. Waterproofing paints, compounds, or sheeting can be effective if properly installed. Equally important is the use of a subdrain that daylights to the atmosphere. The subdrain should be covered with ¾-inch crushed gravel to help the collection of water. Landscaped areas above the wall should be sealed or properly drained to prevent moisture contact with the wall or saturation of wall backfill.

PLAN REVIEW

Formal plans ready for submittal to the Building Department should be reviewed by Byer Geotechnical. Any change in scope of the project may require additional work.

SITE OBSERVATIONS DURING CONSTRUCTION

The building department requires that the geotechnical company provide site observations during construction. The observations include foundation excavations, keyways for fill, benching, pool excavations, temporary slopes and permanent cut slopes. All fill that is placed should be tested for compaction and approved by the soils engineer prior to use for support of engineered structures. The

City of Los Angeles requires that all retaining wall subdrains be observed by a representative of the geotechnical company as well as the city inspector.

Please advise Byer Geotechnical at least 24 hours prior to any required site visit. The agency approved plans and permits should be at the job site and available to our representative. The project consultant will perform the observation and post a notice at the job site of his visit and findings. This notice should be given to the agency inspector.

CONSTRUCTION SITE MAINTENANCE

It is the responsibility of the contractor to maintain a safe construction site. When excavations exist on a site, the area should be fenced and warning signs posted. All pile excavations must be properly covered and secured. Soil generated by foundation and subgrade excavations should be either removed from the site or properly placed as a certified compacted fill. Soil must not be spilled over any descending slope. Workers should not be allowed to enter any unshored trench excavations over five feet deep.

Byer Geotechnical appreciates the opportunity to provide our service on this project. Any questions concerning the data or interpretation of this report should be directed to the undersigned.

Respectfully submitted,
BYER GEOTECHNICAL, INC.

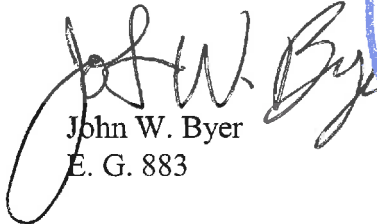

John W. Byer
E. G. 883

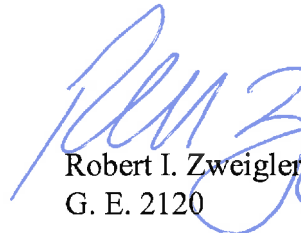
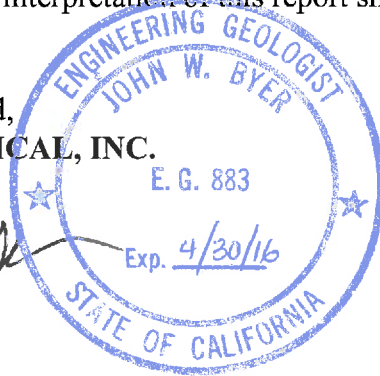

Robert I. Zweigler
G. E. 2120



JWB:RIZ:mh

S:\FINAL\BG\21898_Harvard-Westlake\21898_Harvard-Westlake_Geo_and_Soils_5.18.15_Revised.wpd

DISTRIBUTION AND ENCLOSURES

- Enc: LADBS, Geology and Soils Report Correction Letter, dated April 3, 2013 (3 Pages)
LADBS, conditional approval letters, dated March 15, 1999, and March 18, 1999 (5 Pages)
Appendix I - The J. Byer Group, Inc. (JB 17866-B), excerpts from report dated October 16, 1998
 Laboratory Testing
 Log of Test Pits 1 - 5 (2 Pages)
 Log of Borings 1 - 5 (11 Pages)
Appendix II - Geotechnical Professionals, Inc.
 Report dated July 27, 2010, including
 Direct Shear Test Results (8 Pages)
 Log of Boring No. 1 - 10 (14 Pages)
 Reports dated July 27, 2010, and February 5, 2013, revised February 6, 2013
Appendix III - The J. Byer Group, Inc. (JB17973-B), excerpts from reports dated February 22
and March 4, 1999
 Laboratory Testing
 Shear Test Diagrams (3 Pages)
 Log of Test Pits (4 Pages)
 Log of Borings (14 Pages)
Appendix IV - Byer Geotechnical, Inc. (BG 21401), excerpts from report dated September 20, 2011
 Log of Borings 1 and 2 (4 Pages)
Appendix V - Grover Hollingsworth and Associates, Inc., report dated March 25, 2015
Appendix VI - Laboratory Testing, Calculations, and Figures (Current Study)
 Laboratory Testing
 Table I - Moisture/Density (2 Pages)
 Shear Diagrams (6 Pages)
 Consolidation Diagrams (3 Pages)
 Summary of Corrosion Test Results
 USGS Design Maps Summary Report (2 Pages)
 Seismic Slope Stability Screening Analysis
 Seismic Sources (2 Pages)
 Site-Specific Ground Motion Analysis (2 Pages)
 PSH Deaggregation on NEHRP C Soil
 Surficial Stability Calculation
 Passive Earth Pressure Calculation
 Retaining Wall Calculation Sheets (2 Pages)
 Temporary Excavation Height Calculation
 Shoring Pile Calculation
 Bearing Capacity Analysis (2 Pages)
 Slope Stability Calculations (259 Pages)
 Regional Geologic Maps #1 and #2 (2 Pages)
 Regional Fault Map

DISTRIBUTION AND ENCLOSURES (Continued)

Seismic Hazard Zones Map

All Earthquakes from 4-24-89 to 5-1-2015, 2.0 & Larger within 32 Km Radius from Site Sections 4, 6, and 8 (3 Sheets)

Appendix VII - DRS Engineering, Inc., Preliminary Permanent Soil Nail Wall Design, dated May 18, 2015

Appendix VIII - KPFF Consulting Engineers, Preliminary City of Los Angeles Low Impact Development (LID) and Hydrology Study, both dated April 10, 2015

Appendix IX - IDG Architects, Sheet A2 - Proposed Site Plan, dated May 18, 2015 (As PDF on CD)

In Pocket: CD - Prior Work
 Geologic Map
 Sections 1, 2, 3, 5, and 7
 Regional Topographic Map

xc: (4) Addressee (E-mail and Pick Up)
 (1) David Weil (E-mail)
 (1) DRS Engineering, Attention: David Salter (E-mail)
 (1) IDG Architects, Attention: Steve Kuhn (E-mail)
 (1) John A. Martin & Associates, Attention: Kurt Clandening (E-Mail)
 (1) KPFF Consulting Engineers, Attention: Rick Davis and Douglas Conlon (E-mail)
 (1) Mayer Brown, LLP, Attention: Edgar Khalatian (E-mail)

HELENA JUBANY
PRESIDENT

VAN AMBATIELOS
VICE-PRESIDENT

E. FELICIA BRANNON
VICTOR H. CUEVAS
SEPAD SAMZADEH



ANTONIO R. VILLARAIGOSA
MAYOR

ROBERT R. "BUD" OVROM
GENERAL MANAGER

RAYMOND S. CHAN, C.E., S.E.
EXECUTIVE OFFICER

GEOLOGY AND SOILS REPORT CORRECTION LETTER

April 3, 2013

LOG # 79736
SOILS/GEOLOGY FILE - 2
LAN

Harvard-Westlake School, Attn: John Amato
3700 Coldwater Canyon Avenue
Studio City, CA 91604

TRACT: 1000
LOT(S): 1112 (Arb 45)
LOCATION: 3701, 3801 Coldwater Canyon Avenue

<u>CURRENT REFERENCE REPORT/LETTER(S)</u>	<u>REPORT No.</u>	<u>DATE(S) OF DOCUMENT</u>	<u>PREPARED BY</u>
Update Letter	2270.C	02/06/2013 rev.	GPI
Geology/Soils Report	2270.I	07/27/2010	GPI

The Grading Division of the Department of Building and Safety has reviewed the referenced reports that provide recommendations for a proposed four level parking structure. The proposed parking structure is located along the western flank of Coldwater Canyon with ascending slopes that exceed 200 feet in height. In addition to ascending slopes, the proposed structure will intersect two secondary east-trending drainages. The earth materials at the site consist of uncertified fill, estimated to be up to approximately 20 feet thick, underlain by colluvium/alluvium and Modelo Formation bedrock. To accommodate the propose structure, retaining walls up to 60 high are proposed. Soil nail walls are currently planned for the higher portions of the proposed retaining wall system.

Conformance with the Zoning Code Section 12.21.C8, which limits the heights and number of retaining walls, will be determined during structural plan check and permitting process.

The site is located in a designated seismically induced landslide hazard zone as shown on the "Seismic Hazard Zones" map issued by the State of California.

The review of the subject reports can not be completed at this time and will be continued upon submittal of an addendum to the report which shall include, but not be limited to, the following:

(Note: Numbers in parenthesis () refer to applicable sections of the 2011 City of LA Building Code. P/BC numbers refer the applicable Information Bulletin. Information Bulletins can be accessed on the internet at LADBS.ORG.)

1. Provide recommendations and revise the plan and cross section for providing the required building setback from the toe of the ascending slope as specified by Code Section 1808.7.1.

The building setback as currently shown does not comply with the Building Code or the building setback requirements as outlined in the department's latest public information bulletin P/BC 2011-001. Please review the bulletin (available on-line at www.ladbs.org), and revise the geologic map/plan and the geologic cross-section to comply with the Code and the current building setback requirements.

Notes: Please be informed that the Department does not allow a reduction in building setback, for new buildings. ~~The required setback of 15 feet may be partitioned into two levels using two retaining walls, provided the lower retaining wall is located a minimum clearance from the building of 5 feet.~~

The building clearance from ascending slopes shall be measured horizontally from the face of the building ~~(or from a vertical projection of the building where upper floor/s extend beyond the lower floor)~~ to the toe of the slope, or to the rear-yard wall(s), if any. ~~No part of the structure (including a balcony) shall be located within the building setback area.~~

2. Provide pseudo-static slope stability analysis in conformance with the most recent version of CGS Special Publication 117 (i.e. SP 117A), Guidelines for Evaluating and Mitigating Seismic Hazards in California (1803.7.2). Notes: (1) Ground motions used to evaluate liquefaction or slope stability shall be obtained based on methods prescribed in the 2011 LABC (refer to 1803.5.12). Ground shaking hazard maps found in previous Seismic Hazard Zone Reports shall no longer be used to estimate ground shaking. (2) The seismic coefficient, k_{eq} , shall be derived based on a displacement of 5 cm where critical slip surfaces intersect stiff improvements, such as buildings or pools, otherwise a maximum displacement of 15 cm may be assumed. (3) A minimum safety factor of 1.0 is required.
3. Provide recommendations to adequately protect the proposed building for the potential of surficial instability. Note: ~~Page 19 of the report indicates the existing ascending slope do not have the generally accepted factor of safety for surficial stability.~~
4. Provide an assessment of the potential for debris accumulation behind the rear retaining walls and adequate protective recommendations.
5. Show the tributary drainage/contributing watershed area on a regional topography map and, provide calculations for debris flow control systems within and at the base of concentrated drainage areas, using the minimum design parameters specified in section 7014.3 of the LA City Building Code.

Note: (a) If such calculations are to be provided by a civil engineer, include the wet-signed original of the civil engineer's report, in the addendum; (b) Protective devices shall be permanent structures designed to either isolate, contain, deflect or channelize any potential debris flows.

6. Provide calculations to the lateral earth pressure required to achieve a minimum factor of safety for the proposed walls. The calculations shall consider any potentially adverse bedding conditions that will be exposed in the excavations.

7. Show location of a plane with a minimum 1.5 factor of safety on the cross-section(s) prior to implementation of soil nails.
8. Provide temporary excavation recommendations and calculations to verify that the proposed excavation will be temporarily stable during soil nail wall/retaining wall construction.
9. Provide elevations to show the location of the proposed soil-nails, including the proof and verification nails. The geological map shall also show the location of "proof" and "verification" soil nails.
10. Provide specific recommendations for soil nailing to satisfy the draft document "Recommended Guidelines for Permanent Soil Nails" dated 08/23/2000 by the California Soil Nail Committee, and "Manual for Design & Construction Monitoring of Soil Nail Walls", Publication No. FHWA-SA-96-069R, by U.S. Department of Transportation, Federal Highway Administration.
11. Provide complete geotechnical recommendations for the soil nail retention system supported by appropriate calculations. Include parameters such as: soil nail diameter, length, spacing of centralizers, horizontal & vertical nail spacing, wall face batter and bearing.
12. Provide specific recommendations for corrosion protection/monitoring including the recommended design life.
13. Provide detailed recommendations for instrumentation and monitoring programs and depict the locations on the geologic map. Define the criteria triggering additional monitoring and remedial measures.
14. The monitoring program shall include but not be limited to installing slope inclinometers behind the wall.

The geologist and soils engineer shall prepare a report containing the corrections indicated in this letter. The report shall be in the form of an itemized response. It is recommended that once all correction items have been addressed in a response report, to contact the report review engineer and/or geologist to schedule a verification appointment to demonstrate compliance with all the corrections. Do not schedule an appointment until all corrections have been addressed. Bring three copies of the response report, including one unbound wet-signed original for microfilming in the event that the report is found to be acceptable.

DANIEL C. SCHNEIDEREIT
Engineering Geologist Associate

PASCAL CHALLITA
Geotechnical Engineer II

DCS/PC:dcs/pc
Log No. 79736
213-482-0480

cc: Michael Nytzen, Applicant
GPI, Project Consultant
VN District Office

BOARD OF
BUILDING AND SAFETY
COMMISSIONERS

JOYCE L. FOSTER
PRESIDENT

LEE KANON ALPERT
VICE-PRESIDENT

JEANETTE APPLGATE
MABEL CHANG
ALEJANDRO PADILLA

CITY OF LOS ANGELES
CALIFORNIA



RICHARD J. RIORDAN
MAYOR

DEPARTMENT OF
BUILDING AND SAFETY
201 NORTH FIGUEROA STREET
LOS ANGELES, CA 90012

ANDREW A. ADELMAN
GENERAL MANAGER

RICHARD E. HOLGUIN
EXECUTIVE OFFICER

March 15, 1999

Log # 27226
SOILS/GEOLOGY FILE - 2

Harvard Westlake School
3700 Coldwater Canyon Avenue
North Hollywood, CA 91604

TRACT: 1000/6293
LOT: 1112 (ARB 45)/FR. 135
LOCATION: 3801 Coldwater Cyn. Ave.

<u>CURRENT REFERENCE REPORT/LETTER(S)</u>	<u>REPORT NO.</u>	<u>DATE(S) OF DOCUMENT</u>	<u>PREPARED BY</u>
Geo/Soil Report	JB-17973-B	02/24/1999	The J. Byer Group
Ovrszd Doc

The reference report has been reviewed by Grading Section of the Department of Building and Safety. It is proposed to create a 2:1 cut slope in the southwest portion of the site.

The report is acceptable, provided the following conditions are complied with during the site development:

1. The geologist and soils engineer shall review and approve the detailed plans prior to issuance of any permits. This approval shall be by signature on the plans which clearly indicates that the geologist and soils engineer have reviewed the plans prepared by the design engineer and that the plans include the recommendations contained in their reports.
2. All new graded slopes shall be no steeper than 2:1.
3. All recommendations of the report which are in addition to or more restrictive than the conditions contained herein shall be incorporated into the plans.
4. The interceptor terraces shall be a minimum 8 feet wide, as required by the Code.
5. A diverter terrace shall be provided at the top of the cut slope.
6. If the grading permit involves the import or export of more than 1000 cubic yards of earth materials, and is in the grading hillside area, approval is required by the Board of Building



and Safety. Application for approval of the import-export route should be filed with the Grading Section. Processing time of this application is approximately 8 weeks to hearing plus 10-day appeal period.

7. A grading permit shall be obtained.
8. Secure the written consent from all owners upon whose property the proposed grading is to extend.
9. Grading shall be scheduled for completion prior to the start of the rainy season, or detailed temporary erosion control plans shall be filed in a manner satisfactory to the Department and the Department of Public Works, for any grading work in excess of 200 cu yd.
10. Prior to excavation, an initial inspection shall be called at which time sequence of shoring (if required), protection fences and dust and traffic control will be scheduled.

DAVID HSU
Chief of Grading Section



DANA PREVOST
Engineering Geologist II

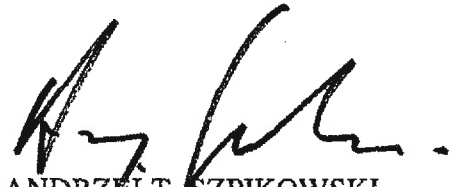

ANDRZEJ T. SZPIKOWSKI
Geotechnical Engineer I

DP/ATS:dp/ats
27726
(213) 977-6329

cc: The J. Byer Group, Inc.
Applicant
VN District Office

BOARD OF
BUILDING AND SAFETY
COMMISSIONERS

JOYCE L. FOSTER
PRESIDENT

LEE KANON ALPERT
VICE-PRESIDENT

JEANETTE APPLIGATE
MABEL CHANG
ALEJANDRO PADILLA

CITY OF LOS ANGELES
CALIFORNIA



RICHARD J. RIORDAN
MAYOR

DEPARTMENT OF
BUILDING AND SAFETY
201 NORTH FIGUEROA STREET
LOS ANGELES, CA 90012

ANDREW A. ADELMAN
GENERAL MANAGER

RICHARD E. HOLGUIN
EXECUTIVE OFFICER

March 18, 1999

Log # 27150

C.D. --

SOILS/GEOLOGY FILE - 2

Harvard Westlake School
3700 Coldwater Canyon Ave
North Hollywood, CA

TRACT: 1000
LOT: 1111
LOCATION: 3700 Coldwater Canyon Av

<u>CURRENT REFERENCE REPORT/LETTER(S)</u>	<u>REPORT NO.</u>	<u>DATE(S) OF DOCUMENT</u>	<u>PREPARED BY</u>
Geology/Soils Report	JB 17866-B	10-23-98	J. Byer Group
" "	" "	10-16-98	" "
<u>PREVIOUS REFERENCE REPORT/LETTER(S)</u>	<u>REPORT NO.</u>	<u>DATE(S) OF DOCUMENT</u>	<u>PREPARED BY</u>
Geology/Soils Report	KB 614	07-16-79	Kovacs-Byer
" "	GSC 614	01-29-73	Geo. & Soils Cons.
Department Letter	n/a	03-07-73	Building & Safety
" "	n/a	12-14-84	" "
" "	26646-01	02-12-99	" "

The reports have been reviewed by the Grading Section of the Department of Building and Safety. The report dated October 23, 1998 relates to the previously approved gymnasium project, and is acknowledged.

According to the October 16, 1998 report, it is planned to construct an attached addition to the existing Taper Athletic Pavilion. The Pavilion was previously explored by, and constructed under the observation of Kovacs-Byer and Associates. The Pavilion is supported on friction piles extending through the alluvium and into the bedrock. Depths to bedrock range from 10 to about 40 feet.

The J. Byer Group accepts responsibility for use of the information provided in the previous reports, pursuant to Code Section 91.7008.5.

The October 16, 1998 report indicates that the site is within an Official State Seismic Hazard Zone (liquefaction). The report indicates that the occurrence of a liquefaction event is low, but will be mitigated by supporting structures on bedrock. This satisfies the requirement of the Los Angeles City Building Code Section 91.1804.5 and the State of California Public Resources Code, Section 2690 et seq. (Seismic Hazard Mapping Act).

The report is acceptable, provided the following conditions are complied with during site development:

1. All footings shall be founded in bedrock, as recommended.
2. Existing uncertified fill shall not be used for support of footings, concrete slabs or new fill.
3. Slab-on-uncertified fill shall be designed as a structural slab.
4. Existing uncertified fill shall not be used for lateral support of deep foundation.
5. All recommendations of the reports which are in addition to or more restrictive than the conditions contained herein shall be incorporated into the plans.
6. All conditions of the above referenced Department letter shall apply.
7. The geologist and soils engineer shall review and approve the detailed plans prior to issuance of any permits. This approval shall be by signature on the plans which clearly indicates that the geologist and soils engineer have reviewed the plans prepared by the design engineer and that the plans include the recommendations contained in their reports.
8. The applicant is advised that the approval of this report does not waive the requirements for excavations contained in the State Construction Safety Orders enforced by the State Division of Industrial Safety.
9. A copy of the subject and appropriate referenced reports and this approval letter shall be attached to the District Office and field set of plans. Submit one copy of the above reports to the Building Department Plan Checker prior to issuance of the permit.
10. The geologist shall inspect all excavations to determine that conditions anticipated in the report have been encountered and to provide recommendations for the correction of hazards found during grading or foundation excavations.
11. All man-made fill shall be compacted to a minimum 90 percent of the maximum dry density of the fill material per the latest version of ASTM D 1557. Where cohesion-less soil having less than 15 percent of finer than 0.005 millimeters is used for fill, it shall be

compacted to a minimum of 95 percent of the maximum dry density.

12. All roof and pad drainage shall be conducted to the street in an acceptable manner.
13. The geologist and soils engineer shall inspect the excavations for the footings to determine that they are founded in the recommended strata before calling the Department for footing inspection.
14. All friction pile or caisson drilling and installation shall be performed under the continuous inspection and approval of the geologist and soils engineer.
15. Prior to the placing of compacted fill, a representative of the consulting Soils Engineer shall inspect and approve the bottom excavations. He shall post a notice on the job site for the City Grading Inspector and the Contractor stating that the soil inspected meets the conditions of the report, but that no fill shall be placed until the City Grading Inspector has also inspected and approved the bottom excavations. A written certification to this effect shall be filed with the Department upon completion of the work. The fill shall be placed under the inspection and approval of the Soils Engineer. A compaction report shall be submitted to the Department upon completion of the compaction.
16. Prior to the pouring of concrete, a representative of the consulting Geologist and Soil Engineer shall inspect and approve the footing excavations. He shall post a notice on the job site for the City Building Inspector and the Contractor stating that the work so inspected meets the conditions of the report, but that no concrete shall be poured until the City Building Inspector has also inspected and approved the footing excavations. A written certification to this effect shall be filed with the Department upon completion of the work.

DAVID HSU
Chief of Grading Section

JEFFREY C. KOFOED
Engineering Geologist II

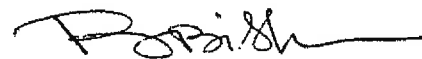
BANWARI BISHNOI
Geotechnical Engineer I

JK/BB:jk/bb
27150
(213) 977-6329

cc: J. Byer Group
Bruce A. Miller & Assoc.
VN District Office

May 18, 2015
BG 21898

APPENDIX I

The J. Byer Group, Inc., excerpts from report dated October 16, 1998

APPENDIX I

LABORATORY TESTING

Undisturbed and bulk samples of the compacted fill, fill, soil, alluvium and bedrock were obtained from the test pits and borings and transported to the laboratory for testing and analysis. The samples were obtained by driving a ring lined barrel sampler conforming to ASTM D-3550 with successive drops of the Kelly bar and hand sampler weight. Experience has shown that sampling causes some disturbance of the sample, however the test results remain within a reasonable range. The samples were retained in brass rings of 2.50 inches outside diameter and 1.00 inches in height. The samples were stored in close fitting, waterproof containers for transportation to the laboratory.

Moisture-Density

The dry density of the samples was determined using the procedures outlined in ASTM D-2937. The moisture content of the samples was determined using the procedures outlined in ASTM D-2216. The results are shown on the Log of Test Pits and Log of Borings.

Shear-Tests

Shear tests were performed on samples of future compacted fill, soil, and bedrock using the procedures outlined in ASTM D-3080 and a strain controlled, direct shear machine manufactured by Soil Test, Inc. The rate of deformation was 0.025 for the bedrock and future compacted fill samples and 0.010 inches per minute for the soil samples. The samples were tested in an artificially saturated condition. Following the shear test, the moisture content of the samples was determined to verify saturation. The results are plotted on the "Shear Test Diagrams".

Consolidation

Consolidation tests were performed on insitu samples of the alluvium. Results are graphed on the "Consolidation Curves".



THE J. BYER GROUP, INC.
A GEOTECHNICAL CONSULTING FIRM

512 E. WILSON AVENUE SUITE 201, GLENDALE, CA 91206
818-549-9959 Tel 818-543-3747 Fax

LOG OF TEST PITS

JB: 17866-B CLIENT: HARVARD-WESTLAKE
GEOLOGIST: JWB DATE LOGGED: 9/30/98
REPORT DATE: 10/16/98

TEST PIT #1

SAMPLE DEPTH (feet)	MOISTURE CONTENT (%)	DRY DENSITY (pcf)	DEPTH INTERVAL (feet)	EARTH MATERIAL	LITHOLOGIC DESCRIPTION
			0 - 2	COLLUVIUM:	Silty Clay, dark gray, moist, firm, rock fragments to 1 inch
			2 - 3		rock fragments up to 4 inches
			3 - 6	BEDROCK:	Diatomaceous Shale, light brown, slightly moist, moderately hard, Bedding: N80E; 88N

End at 6 Feet; No Water; No Caving; No Fill.

TEST PIT #2

			0 - 2	FILL:	Clayey Silt, dark brown, moist, slightly dense, contains rock fragments, concrete, steel and brick
			2 - 3		1 inch diameter pipe
			3 - 4		2½ inch diameter pipe
			4 - 4½		bottom of footing, top of metal pipe - 30 inches diameter

End at 4½ Feet; No Water; No Caving; Fill to Total Depth.

TEST PIT #3

			0 - 3	FILL:	Silty Sand, brown, moist, dense, contains fragments of concrete and brick
			3 - 4½	COLLUVIUM:	Silty Clay, dark brown, moist, firm, roots up to 1 inch, rock fragments to ½ inch
			4½ - 6		bottom of footing at 4½ feet
			6 - 7		rock fragments up to 4 inches
			7 - 8	BEDROCK:	Diatomaceous Shale, tan, hard, Bedding: E-W: 90

End at 8 Feet; No Water; No Caving; Fill to 3 Feet.

NOTE: The stratification depths shown on the Log of Test Pits are approximate and are based upon visual classification of samples and cuttings. The actual depths may vary. Variations between test pits may also occur.



THE J. BYER GROUP, INC.
A GEOTECHNICAL CONSULTING FIRM

512 E. WILSON AVENUE SUITE 201, GLENDALE, CA 91206
818-549-9959 Tel 818-543-3747 Fax

LOG OF TEST PITS

JB: 17866-B CLIENT: HARVARD-WESTLAKE
GEOLOGIST: JWB DATE LOGGED: 9/30/98
REPORT DATE: 10/16/98

TEST PIT #4

SAMPLE DEPTH (feet)	MOISTURE CONTENT (%)	DRY DENSITY (pcf)	DEPTH INTERVAL (feet)	EARTH MATERIAL	LITHOLOGIC DESCRIPTION
			0 - 4	COLLUVIUM:	Clayey Silt, brown, moist, firm, contains diatomaceous rock fragments to 3 inches
			4 - 6	BEDROCK:	Diatomaceous Shale, tan, hard, Bedding: N87E; 87N

End at 6 Feet; No Water; No Caving; No Fill.

TEST PIT #5

			0 - ½	COLLUVIUM:	Sandy Silt, brown, moist, soft, roots to 2 inches
			½ - 3	BEDROCK:	Diatomaceous Shale, white, dry, moderately hard, well bedded, Bedding: N84E; 90

End at 3 Feet; No Water; No Caving; No Fill.

NOTE: The stratification depths shown on the Log of Test Pits are approximate and are based upon visual classification of samples and cuttings. The actual depths may vary. Variations between test pits may also occur.

Project No: JB 17866-B

Log of Boring 1

The J. Byer Group, Inc.
 512 East Wilson Ave., Suite 201
 Glendale, CA 91206
 (818) 549-9959

Client: HARVARD-WESTLAKE SCHOOL

Location: 3700 Coldwater Canyon Avenue

By: JWB

SUBSURFACE PROFILE		SAMPLE			Lab Data		PHI Angle (degrees)	Cohesion (psf)	Remarks
Elevation	Depth	Description	Symbol	USCS	Type	Blow Count Per Foot			
697	0	Ground Surface							
		FILL							
696	1	Silty Sand and Silty Clay, light brown, moist, slightly dense, soft							
695	2				R	10	12.8	93.5	
694	3								
693	4								
692	5	COLLUVIUM							
691	6	Silty Clay, dark brown, very moist, firm							
690	7	Sandy Clay, dark brown, moist, soft, rock fragments to 1/4 inch			R	9	25.4	87.9	
689	8								
688	9	Clayey Silt, medium brown, moist, firm			R	9	38.1	76.5	
687	10								
686	11								
685	12				R	12	34.8	79.7	
684	13								
683	14	Silty Clay, light brown, moist to very moist, soft porous			R	9	42.1	73.8	
682	15								
681	16								
680	17	Clayey Silt, brown, wet, soft, contains rock fragments up to 2 inches			R	10	72.4	57.8	
679	18	water at 18 feet							
678	19						64.8	58.1	
677	20								

Surface: 5 Inch Concrete Parking Lot

Drill Method: Hollow-Stem Auger

Drill Date: 9/30/98

Size: 8 Inch

Elevation: 697

Sheet: 1 of 3

Project No: JB 17866-B



Log of Boring 1

The J. Byer Group, Inc.
 512 East Wilson Ave., Suite 201
 Glendale, CA 91208
 (818) 549-9959

Client: HARVARD-WESTLAKE SCHOOL

Location: 3700 Coldwater Canyon Avenue

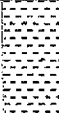
By: JWB

SUBSURFACE PROFILE		SAMPLE			Lab Data		PHI Angle (degrees)	Cohesion (psf)	Remarks
Elevation	Depth	Description	Symbol	USCS	Type	Blow Count Per Foot			
676	21	WEATHERED BEDROCK Diatomaceous Shale, light brown, moist, soft		---	R	10			
675	22	BEDROCK Diatomaceous Siltstone and Shale, gray, moist, moderately hard, well bedded, saturate d		---	R	15	84.9	49.2	
674	23					20	75.4	52.0	
673	24	End at 25 Feet; Water at 18 Feet; Fill to 5 Feet		---	R				
672	25								
671	26								
670	27								
669	28								
668	29								
667	30								
666	31								
665	32								
664	33								
663	34								
662	35								
661	36								
660	37								
659	38								
658	39								
657	40								

Surface: 5 Inch Concrete Parking Lot

Drill Method: Hollow-Stem Auger

Drill Date: 9/30/98

Size: 8 Inch

Elevation: 697

Sheet: 2 of 3

Project No: JB 17866-B

Log of Boring 2

Client: HARVARD-WESTLAKE SCHOOL

The J. Byer Group, Inc.
512 East Wilson Ave., Suite 201
Glendale, CA 91206
(818) 549-9959

Location: 3700 Coldwater Canyon Avenue

By: JWB

SUBSURFACE PROFILE		SAMPLE			Lab Data			PHI Angle (degrees)	Cohesion (psf)	Remarks
Elevation	Depth	Description	Symbol	USCS	Type	Blow Count Per Foot	Moisture Content (%)			
698	0	Ground Surface								
		FILL								
697	1	Silty Clay, dark brown, moist, slightly firm, rock fragments up to 1 inch	///							
696	2		///							
695	3		///							
694	4		///							
693	5		///		R	10	35.3	78.9		
692	6	COLLUVIUM								
691	7	Sandy Silt, brown, moist, soft, porous, rock fragments to 1 inch	///							
690	8		///							
689	9		///							
688	10		///		R	16	26.1	87.8		
687	11		///							
686	12		///							
685	13		///							
684	14	WEATHERED BEDROCK								
683	15	Diatomaceous Siltstone and Sandstone, light brown, moist, moderately hard, very fractured, well bedded	xxxxx		R	50 11"	N/R	N/R		N/R = No Recovery
682	16		xxxxx							
681	17		xxxxx							
680	18	water at 18 feet	xxxxx							
679	19	BEDROCK								
		Diatomaceous Siltstone and Sandstone, light brown, very wet, moderately hard	xxxxx		R	50 11"	17.1	109.7		
678	20		xxxxx							

Surface: 4 Inches Concrete/2 Inches Base

Drill Method: Hollow-Stem Auger

Drill Date: 9/30/98

Size: 8 Inch

Elevation: 698

Sheet: 1 of 2

Project No: JB 17866-B

Log of Boring 2

The J. Byer Group, Inc.
512 East Wilson Ave., Suite 201
Glendale, CA 91206
(818) 549-9959

Client: HARVARD-WESTLAKE SCHOOL

Location: 3700 Coldwater Canyon Avenue

By: JWB

SUBSURFACE PROFILE			SAMPLE			Lab Data			Remarks		
Elevation	Depth	Description	Symbol	USCS	Type	Blow Count Per Foot	Moisture Content (%)	Dry Density (pcf)		PHI Angle (degrees)	Cohesion (psf)
		End at 20 Feet; Water at 18 Feet; Fill to 6 Feet									
677	21										
676	22										
675	23										
674	24										
673	25										
672	26										
671	27										
670	28										
669	29										
668	30										
667	31										
666	32										
665	33										
664	34										
663	35										
662	36										
661	37										
660	38										
659	39										
658	40										

Surface: 4 Inches Concrete/2 Inches Base

Drill Method: Hollow-Stem Auger

Drill Date: 9/30/98

Size: 8 Inch

Elevation: 698

Sheet: 2 of 2

Project No: JB 17866-B

Log of Boring 3

Client: HARVARD-WESTLAKE SCHOOL

The J. Byer Group, Inc.
 512 East Wilson Ave., Suite 201
 Glendale, CA 91206
 (818) 549-9959

Location: 3700 Coldwater Canyon Avenue

By: JWB

SUBSURFACE PROFILE		SAMPLE			Lab Data		PHI Angle (degrees)	Cohesion (psf)	Remarks
Elevation	Depth	Description	Symbol	USCS	Type	Blow Count Per Foot			
698	0	Ground Surface							
		FILL							
697	1	Silty Clay, dark brown, moist, soft, rock fragments to 1/2 inch							
696	2								
695	3								
694	4								
693	5				R	12	23.3	97.6	
692	6	Silty Sand, reddish brown, moist, slightly dense, rock fragments to 1/2 inch							
691	7								
690	8								
689	9								
688	10				R	20	20.3	95.2	
687	11								
686	12								
685	13								
684	14	ALLUVIUM							
683	15	Clayey Sand, medium brown, wet, slightly dense			R	9	27.5	94.6	
682	16								
681	17								
680	18	water at 18 feet							
679	19								
678	20				R	7	36.1	89.2	

Surface: 4 Inches Concrete w/Wire Mesh

Size: 8 Inch

Drill Method: Hollow-Stem Auger

Elevation: 698

Drill Date: 9/30/98

Sheet: 1 of 3

Project No: JB 17866-B

Log of Boring 3

The J. Byer Group, Inc.
 512 East Wilson Ave., Suite 201
 Glendale, CA 91206
 (818) 549-9959

Client: HARVARD-WESTLAKE SCHOOL

Location: 3700 Coldwater Canyon Avenue

By: JWB

SUBSURFACE PROFILE			SAMPLE				Lab Data		PHI Angle (degrees)	Cohesion (psf)	Remarks
Elevation	Depth	Description	Symbol	USCS	Type	Blow Count Per Foot	Moisture Content (%)	Dry Density (pcf)			
677	21	Clayey Sand, brown, wet, slightly dense, shale fragments to 1 inch	[Symbol]								
676	22										
675	23										
674	24	Clayey Silt, dark brown, wet, soft, shale fragments to 1/2 inch	[Symbol]								
673	25										
672	26										
671	27	[Symbol]									
670	28										
669	29										
668	30	sample disturbed, rock in tip of sampler	[Symbol]		R	17	30.4	93.0			
667	31	[Symbol]									
666	32										
665	33										
664	34	Clayey Sand, brown, wet, slightly dense, some gravel	[Symbol]								
663	35										
662	36										
661	37	[Symbol]									
660	38										
659	39										
658	40		[Symbol]		R	14	36.5	81.8			

Surface: 4 Inches Concrete w/Wire Mesh

Drill Method: Hollow-Stem Auger

Drill Date: 9/30/98

Size: 8 Inch

Elevation: 698

Sheet: 2 of 3

Project No: JB 17866-B

Log of Boring 3

Client: HARVARD-WESTLAKE SCHOOL

The J. Byer Group, Inc.
 512 East Wilson Ave., Suite 201
 Glendale, CA 91206
 (818) 549-9959

Location: 3700 Coldwater Canyon Avenue

By: JWB

SUBSURFACE PROFILE		SAMPLE			Lab Data		PHI Angle (degrees)	Cohesion (psf)	Remarks
Elevation	Depth	Description	Symbol	USCS	Type	Blow Count Per Foot			
657	41	more gravel and cobbles							
656	42								
655	43								
654	44								
653	45	BEDROCK							
652	46	Diatomaceous Shale, gray, moderately hard, well bedded, bedding near vertical in sample			R	50	50.6	69.8	
651	47								
650	48								
649	49	End at 50 Feet; Water at 18 Feet; Fill to 14 Feet.							
648	50				R	50 11"	50.7	71.2	
647	51								
646	52								
645	53								
644	54								
643	55								
642	56								
641	57								
640	58								
639	59								
638	60								

Surface: 4 Inches Concrete w/Wire Mesh

Size: 8 Inch

Drill Method: Hollow-Stem Auger

Elevation: 698

Drill Date: 9/30/98

Sheet: 3 of 3

Project No: JB 17866-B

Log of Boring 4

Client: HARVARD-WESTLAKE SCHOOL

The J. Byer Group, Inc.
 512 East Wilson Ave., Suite 201
 Glendale, CA 91206
 (818) 549-9959

Location: 3700 Coldwater Canyon Avenue

By: JWB

SUBSURFACE PROFILE			SAMPLE				Lab Data		PHI Angle (degrees)	Cohesion (psf)	Remarks
Elevation	Depth	Description	Symbol	USCS	Type	Blow Count Per Foot	Moisture Content (%)	Dry Density (pcf)			
708	0	Ground Surface									
		FILL									
707	1	Silty Clay, dark brown, moist, firm, contains rock fragments, brick									
706	2										
705	3										
704	4	COLLUVIUM:									
703	5	Clayey Silt, dark brown, moist, very firm, rock fragments		—	R	11	26.9	89.7			
702	6										
701	7										
700	8										
699	9	grades lighter brown, more rock fragments									
698	10			---	R	12	29.6	87.1			
697	11										
696	12										
695	13	Clayey Silt, medium brown, moist, firm, very porous, rock fragments to ¼ inch									
694	14										
693	15			---	R	17	24.0	82.5			
692	16										
691	17										
690	18										
689	19			---	R	26	28.9	94.0			
688	20										

Surface: 3 Inches Asphalt/4 Inches Base

Drill Method: Hollow-Stem Auger

Drill Date: 9/30/98

Size: 8 Inch

Elevation: 708

Sheet: 1 of 2

Project No: JB 17866-B

Log of Boring 4

Client: HARVARD-WESTLAKE SCHOOL

The J. Byer Group, Inc.
512 East Wilson Ave., Suite 201
Glendale, CA 91206
(818) 549-9959

Location: 3700 Coldwater Canyon Avenue

By: JWB

SUBSURFACE PROFILE		SAMPLE			Lab Data		PHI Angle (degrees)	Cohesion (psf)	Remarks
Elevation	Depth	Description	Symbol	USCS	Type	Blow Count Per Foot			
687	21	Clayey Silt, dark brown, moist, firm, shale fragments to ¼ inch, porous							
686	22								
685	23	ALLUVIUM							
684	24	Silty Sand, brown, moist, medium dense							
683	25			—	R	27	18.7	95.5	
682	26								
681	27								
680	28								
679	29								
678	30								
677	31								
676	32	WEATHERED BEDROCK							
675	33	Diatomaceous Shale, tan, moist, soft							
674	34								
673	35	End at 35 Feet; No Water; Fill to 4 Feet.		—	R	39	43.9	97.4	
672	36								
671	37								
670	38								
669	39								
668	40								

Surface: 3 Inches Asphalt/4 Inches Base

Size: 8 Inch

Drill Method: Hollow-Stem Auger

Elevation: 708

Drill Date: 9/30/98

Sheet: 2 of 2

Project No: JB 17866-B

Log of Boring 5

Client: HARVARD-WESTLAKE SCHOOL

The J. Byer Group, Inc.
512 East Wilson Ave., Suite 201
Glendale, CA 91206
(818) 549-9959

Location: 3700 Coldwater Canyon Avenue

By: JWB

SUBSURFACE PROFILE		SAMPLE		Lab Data		PHI Angle (degrees)	Cohesion (psf)	Remarks
Elevation	Description	Symbol	Type	Blow Count Per Foot	Moisture Content (%)			
706	Ground Surface							
	FILL							
705	Silty Clay, dark brown, moist, slightly firm, rock fragments to 2 inches							
704								
703								
702	COLLUVIUM							
701	Clayey Silt, dark gray brown, moist, firm, small rock fragment, porous		R	10	33.7	78.7		
700								
699								
698	ALLUVIUM							
697	Silty Sand, brown, moist, medium dense, shale fragments to 1 inch							
696			R	13	20.7	99.7		
695								
694								
693								
692								
691	more Silt, less gravel		R	22	19.6	97.0		
690								
689								
688								
687			R	15	27.1	94.9		
686								

Surface: 5 Inches Asphalt

Drill Method: Hollow-Stem Auger

Drill Date: 9/30/98

Size: 8 Inch

Elevation: 706

Sheet: 1 of 2

Project No: JB 17866-B

Log of Boring 5

Client: HARVARD-WESTLAKE SCHOOL

The J. Byer Group, Inc.
512 East Wilson Ave., Suite 201
Glendale, CA 91206
(818) 549-9959

Location: 3700 Coldwater Canyon Avenue

By: JWB

SUBSURFACE PROFILE			SAMPLE				Lab Data		PHI Angle (degrees)	Cohesion (psf)	Remarks
Elevation	Depth	Description	Symbol	USCS	Type	Blow Count Per Foot	Moisture Content (%)	Dry Density (pcf)			
685	21	rock fragments to 2 inches									
684	22										
683	23	BEDROCK									
682	24	Diatomaceous Shale, light brown, saturated, soft Water at 23 Feet									
681	25				R	15	50.4	70.5			
680	26	grades to moderately hard, bedded									
679	27										
678	28										
677	29										
676	30				R	18	59.6	64.0			
675	31										
674	32	grades to very dark gray, moderately hard, tight									
673	33										
672	34										
671	35	End at 35 Feet; Water at 23 Feet; Fill to 4 Feet			R	50 7"	39.3	77.7			
670	36										
669	37										
668	38										
667	39										
666	40										

Surface: 5 Inches Asphalt
Drill Method: Hollow-Stem Auger
Drill Date: 9/30/98

Size: 8 Inch
Elevation: 706
Sheet: 2 of 2

May 18, 2015
BG 21898

APPENDIX II

Geotechnical Professionals, Inc., reports dated July 27, 2010,
July 27, 2010, and February 5, 2013, revised February 6, 2013

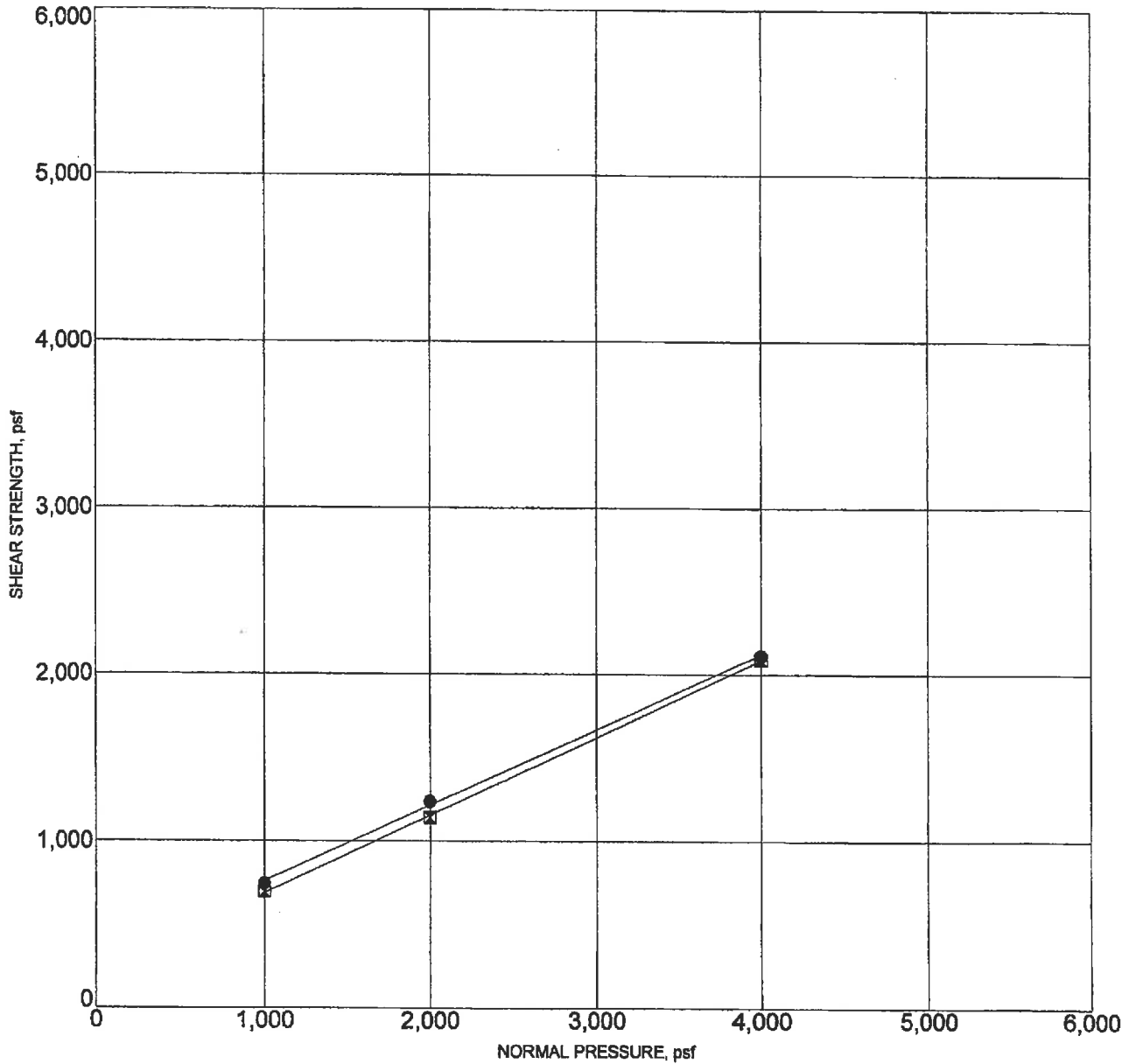

● **PEAK STRENGTH**
 Friction Angle= 24 degrees
 Cohesion= 306 psf

☐ **ULTIMATE STRENGTH**
 Friction Angle= 25 degrees
 Cohesion= 222 psf

Note: Samples remolded to 90% of maximum dry density

Sample Location	Classification	DD,pcf	MC,%
B-2 10-15	SANDY SILT (MH)	81	29.0

PROJECT: HARVARD-WESTLAKE

PROJECT NO.: 2270.1



DIRECT SHEAR TEST RESULTS

FIGURE B-2

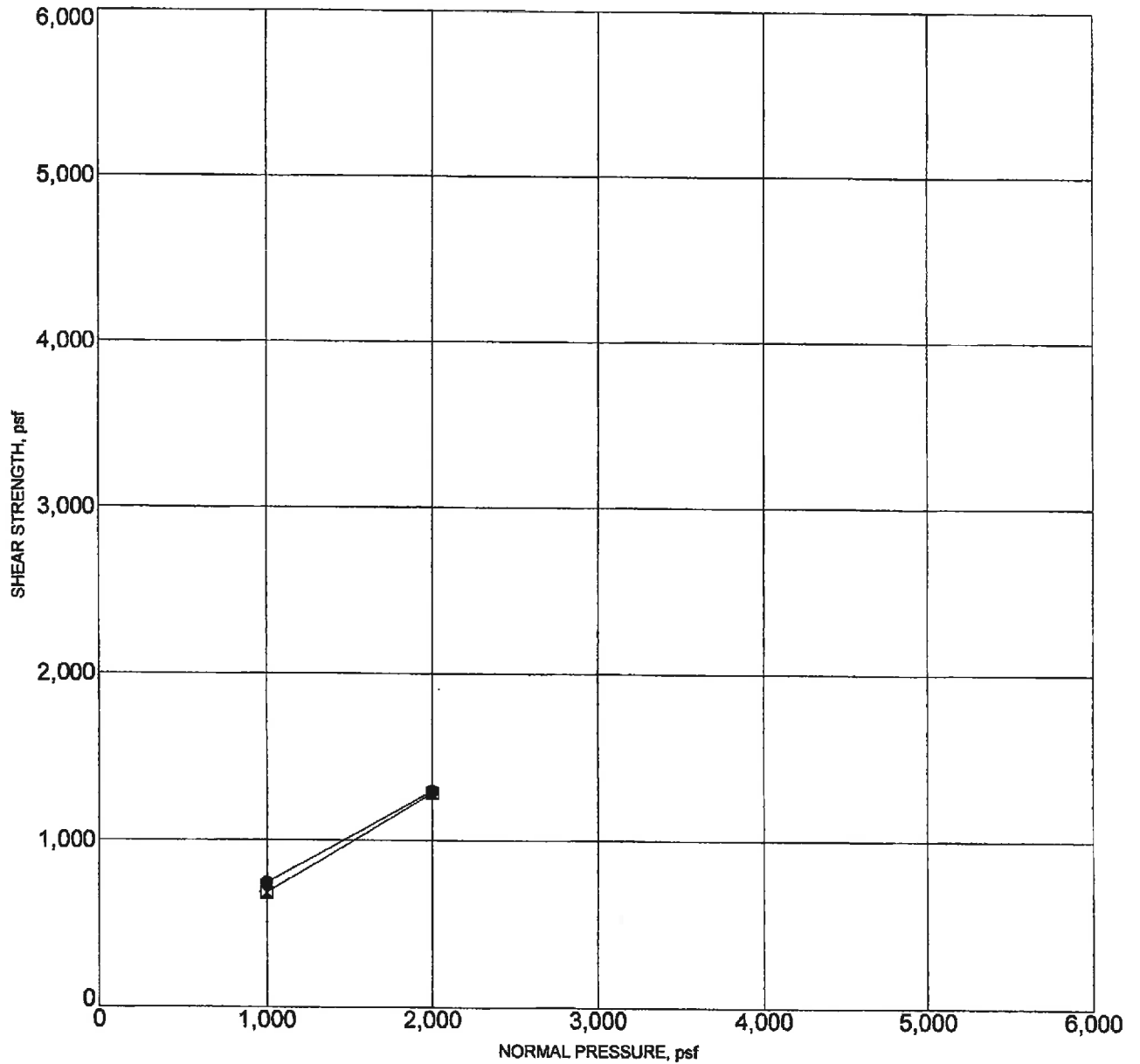

● **PEAK STRENGTH**
Friction Angle= 29 degrees
Cohesion= 192 psf

■ **ULTIMATE STRENGTH**
Friction Angle= 31 degrees
Cohesion= 84 psf

Sample Location	Classification	DD,pcf	MC,%
B-2 15.0	SILT (MH)	72	19.4

PROJECT: HARVARD-WESTLAKE

PROJECT NO.: 2270.1



DIRECT SHEAR TEST RESULTS

FIGURE B-3

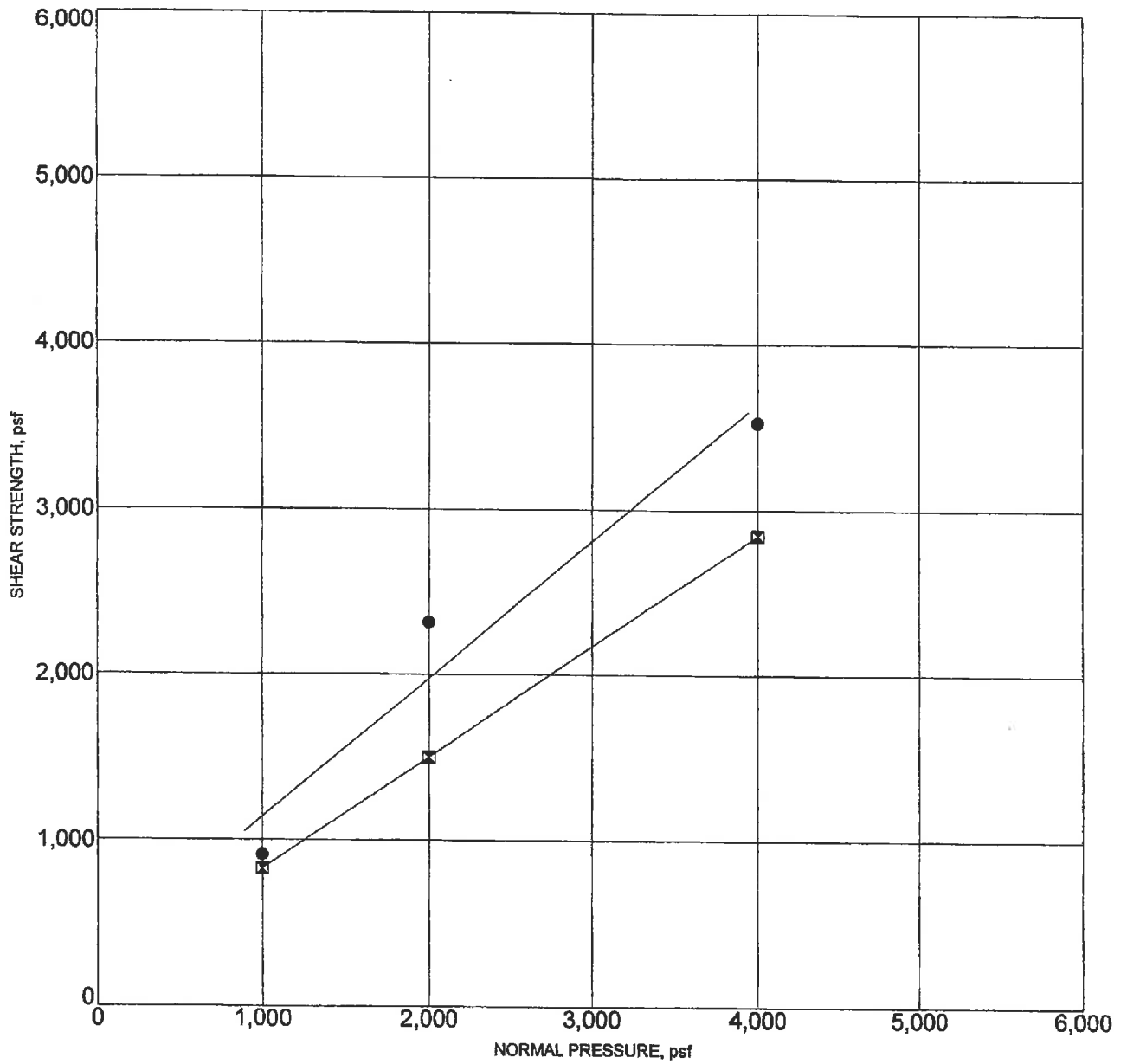

● **PEAK STRENGTH**
 Friction Angle= 40 degrees
 Cohesion= 306 psf

⊠ **ULTIMATE STRENGTH**
 Friction Angle= 34 degrees
 Cohesion= 156 psf

Note: Samples remolded to 90% of maximum dry density

Sample Location	Classification	DD,pcf	MC,%
B-3 20-30	SILTSTONE	71	40.5

PROJECT: HARVARD-WESTLAKE

PROJECT NO.: 2270.1



DIRECT SHEAR TEST RESULTS

FIGURE B-4

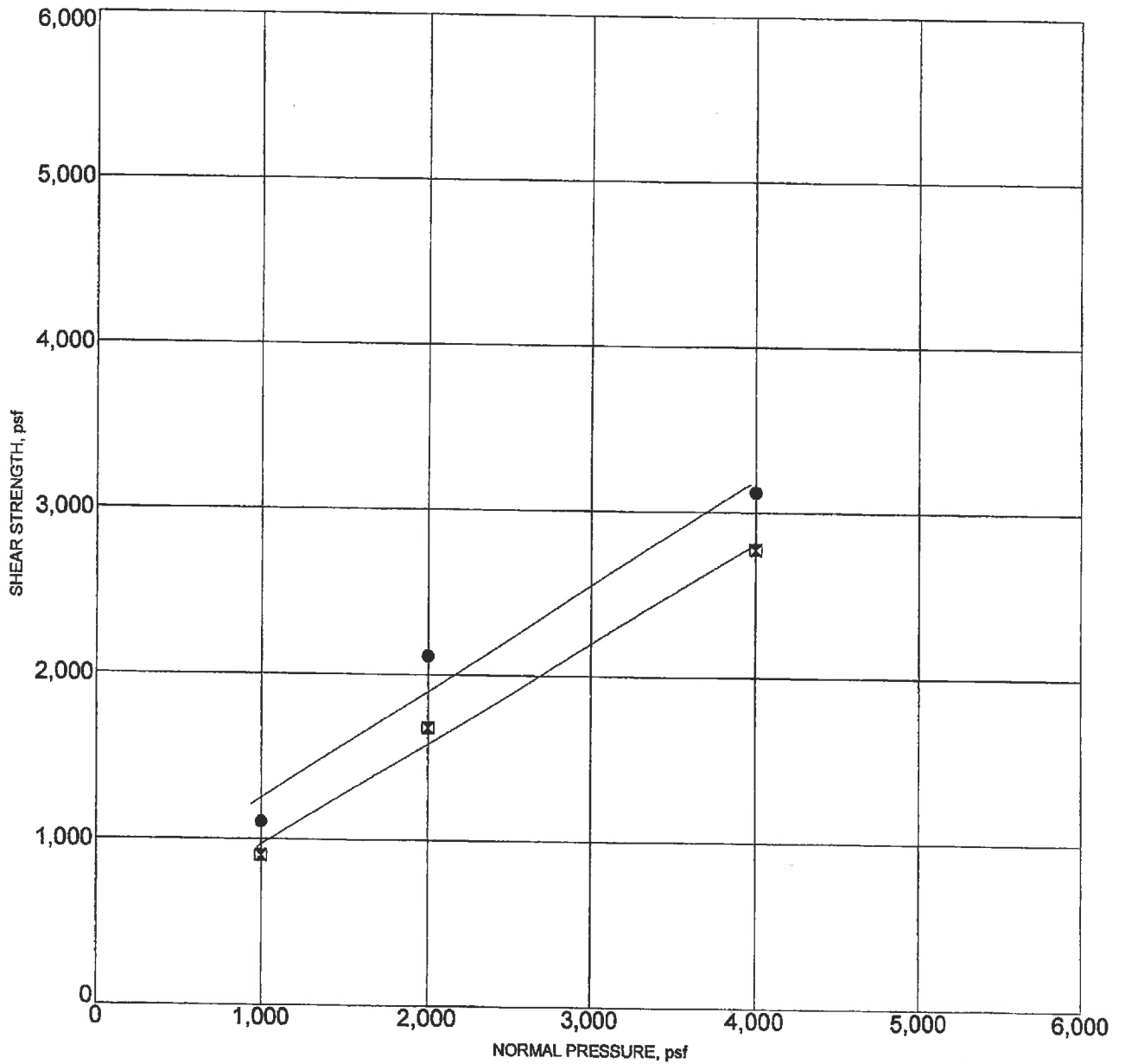

● **PEAK STRENGTH**
Friction Angle= 33 degrees
Cohesion= 600 psf

☒ **ULTIMATE STRENGTH**
Friction Angle= 32 degrees
Cohesion= 354 psf

Sample Location	Classification	DD,pcf	MC,%
B-3 35.0	SILTSTONE	71	44.4

PROJECT: HARVARD-WESTLAKE

PROJECT NO.: 2270.1



DIRECT SHEAR TEST RESULTS

FIGURE B-5

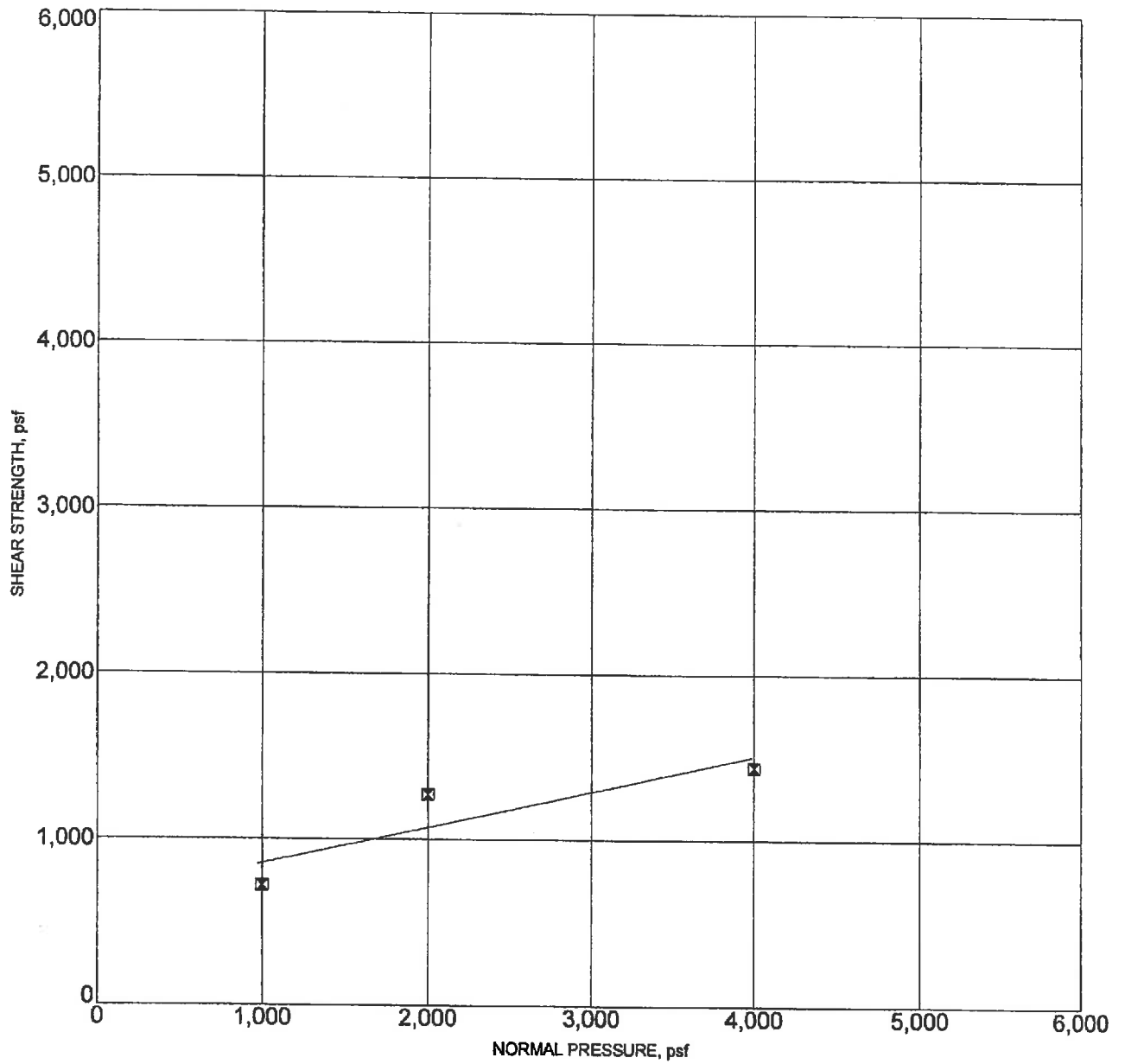

RESIDUAL STRENGTH
 Friction Angle= 12 degrees
 Cohesion= 636 psf

Sample Location	Classification	DD,pcf	MC,%
B-2 25.0	SILTSTONE	77	32.7

PROJECT: HARVARD-WESTLAKE

PROJECT NO.: 2270.1



DIRECT SHEAR TEST RESULTS

FIGURE B-6

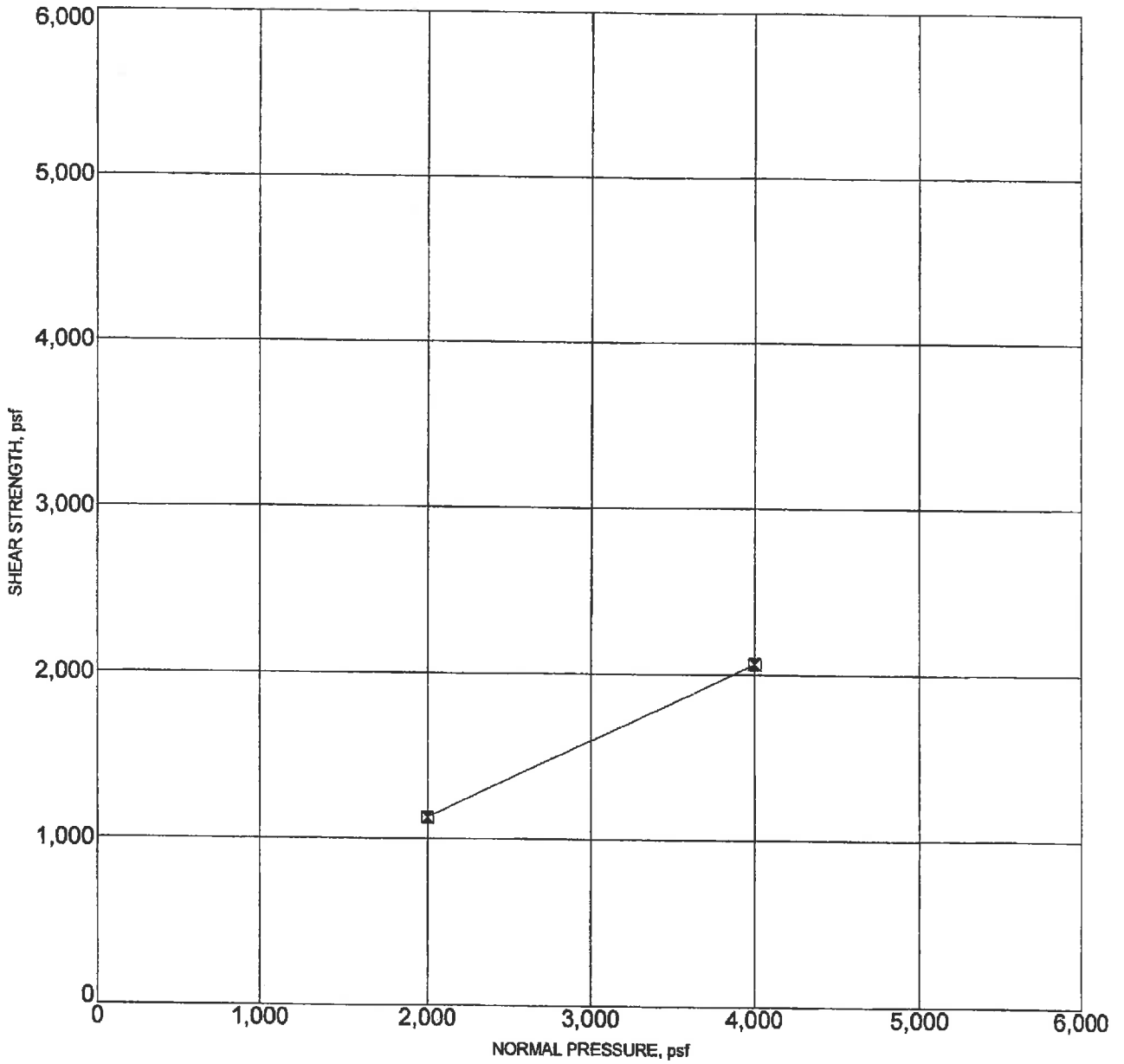

Sample Location	Classification	DD,pcf	MC,%
B-3 20.0	SILTSTONE	87	28.4

PROJECT: HARVARD-WESTLAKE

PROJECT NO.: 2270.1



DIRECT SHEAR TEST RESULTS

FIGURE B-7

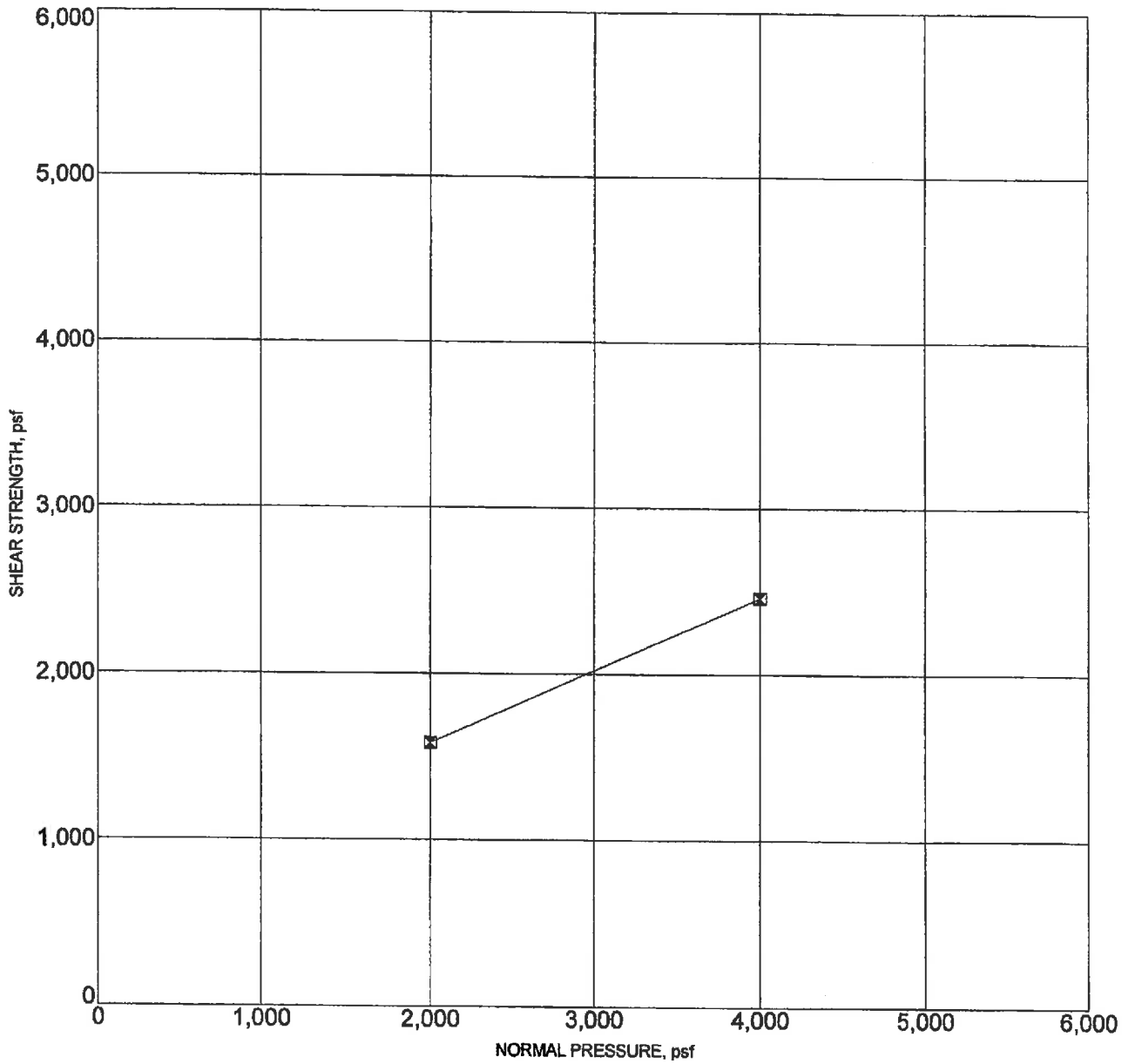

RESIDUAL STRENGTH
 Friction Angle= 24 degrees
 Cohesion= 708 psf

Sample Location	Classification	DD,pcf	MC,%
B-4 20.0	SILTSTONE	55	67.7

PROJECT: HARVARD-WESTLAKE

PROJECT NO.: 2270.1



DIRECT SHEAR TEST RESULTS

FIGURE B-8

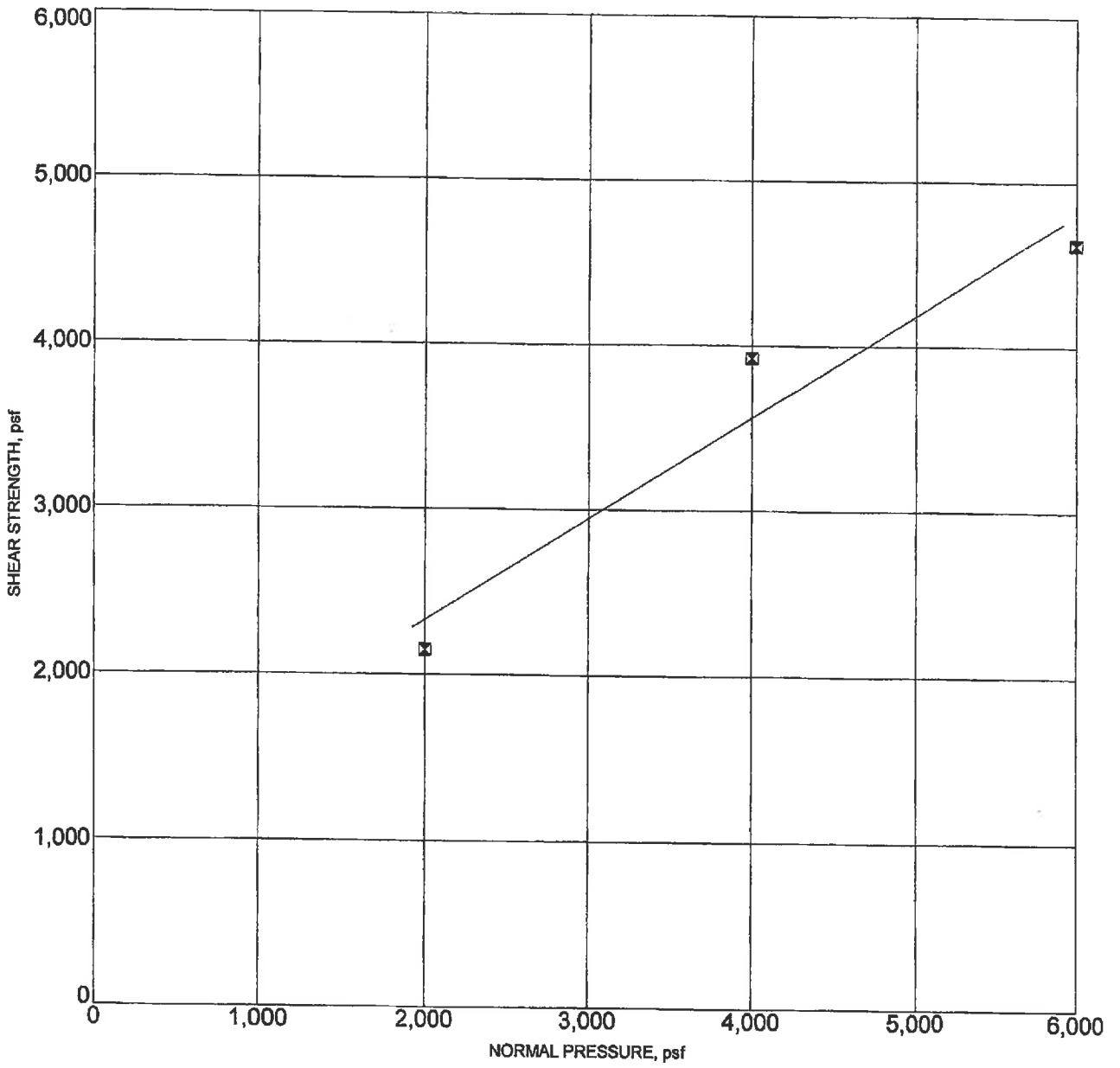

RESIDUAL STRENGTH
 Friction Angle= 32 degrees
 Cohesion= 1092 psf

Sample Location	Classification	DD,pcf	MC,%
B-4 65.0	SILTSTONE	57	63.0



PROJECT: HARVARD-WESTLAKE

PROJECT NO.: 2270.1

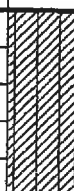

DIRECT SHEAR TEST RESULTS

FIGURE B-9

MOISTURE (%)	DRY DENSITY (PCF)	PENETRATION RESISTANCE (BLOWS/FOOT)	SAMPLE TYPE	DEPTH (FEET)	DESCRIPTION OF SUBSURFACE MATERIALS		ELEVATION (FEET)
					This summary applies only at the location of this boring and at the time of drilling. Subsurface conditions may differ at other locations and may change at this location with the passage of time. The data presented is a simplification of actual conditions encountered.		
				0		Alluvium/Colluvium: SILTY CLAY (CL) dark brown, slightly moist, soft, porous, with 20-30% white, gravel-cobble size shale fragments, with many roots	760
18.4	61	3	D	5		SANDY SILT (ML) brown, very moist, very stiff @ 6' and 10'-6", thick gravel beds of shale fragments, irregular	755
19.3	65	3	D	10			
25.7	82	9	D	15		Monterey Formation: SILTSTONE gray to light brown, very moist, hard, highly weathered, fractured, diatomaceous shale No continuous or coherent bedding @ 13 feet, hard, intact diatomaceous shale with continuous bedding. Mod-highly fractured with open fractures 1/8" to 1/4" wide @ 13.5 feet, B: N78E, 71NW @ 15.5 feet, B: N76E, 74NW J: N10E, 44SE Gypsum filled joints at 6"-12" spacing @ 17.5 feet, B: N72E, 74NW J: N10W, 34NE As above, 6"-12" spacing, gypsum filled	750 745
37.7	72	11	D	20		Total Depth 21 feet No water or caving Backfilled and tamped with drill cuttings	

SAMPLE TYPES

- Rock Core
- Standard Split Spoon
- Drive Sample
- Bulk Sample
- Tube Sample

DATE DRILLED:

11-18-09

EQUIPMENT USED:

24" Bucket Auger

GROUNDWATER LEVEL (ft):

Not Encountered



PROJECT NO.: 2270.1
HARVARD-WESTLAKE

LOG OF BORING NO. B-1

FIGURE A-1

MOISTURE (%)	DRY DENSITY (PCF)	PENETRATION RESISTANCE (BLOWS/FOOT)	SAMPLE TYPE	DEPTH (FEET)	DESCRIPTION OF SUBSURFACE MATERIALS		ELEVATION (FEET)
					This summary applies only at the location of this boring and at the time of drilling. Subsurface conditions may differ at other locations and may change at this location with the passage of time. The data presented is a simplification of actual conditions encountered.		
				0	Alluvium/Colluvium:		745
					SANDY SILT (ML) dark brown, dry to slightly moist, soft, porous, with white diatomaceous shale fragments, roots to 2-3" diameter, massive		
18.3	63	2	D	5	@ 5 feet, stiff		740
					@ 8 feet, 6"-8" thick, poorly defined gravel bed of shale fragments		
20.4	64	2	D	10			735
29.0	81						
25.0	85						
25.0	85						
19.4	72	3	D	15	@ 14 feet, poorly defined gravel bed of shale fragments		730
					SILT (MH) brown, wet, very stiff		
22.8	63	3	D	20			725
32.7	77	10	D	25	Monterey Formation:		720
					SILTSTONE gray to light brown, very moist, hard, high weathered with soil pockets, no continuous bedding		
					@ 25 feet, highly fractured but hard shale with gypsum filled fractures		
					B: N74E, 81SE		
				30			715
41.4	69	6/6"	D	35	@ 33 feet, B: N71E, 78NW, shale continues highly fractured with filled and partially filled gypsum seams		710
					@ 38 feet, B: N72E, 78NW, shale is very hard with gypsum filled fractures		

SAMPLE TYPES

- Rock Core
- Standard Split Spoon
- Drive Sample
- Bulk Sample
- Tube Sample

DATE DRILLED:
11-18-09

EQUIPMENT USED:
24" Bucket Auger

GROUNDWATER LEVEL (ft):
Not Encountered



PROJECT NO.: 2270.1
HARVARD-WESTLAKE

LOG OF BORING NO. B-2

	MOISTURE (%)	DRY DENSITY (PCF)	PENETRATION RESISTANCE (BLOWS/FOOT)	SAMPLE TYPE	DEPTH (FEET)	DESCRIPTION OF SUBSURFACE MATERIALS		ELEVATION (FEET)
						This summary applies only at the location of this boring and at the time of drilling. Subsurface conditions may differ at other locations and may change at this location with the passage of time. The data presented is a simplification of actual conditions encountered.		
	42.0	70	30/9"	D	40		@ 40 feet, all joints tight, filled with gypsum, shale is very hard	705
					45		@ 45 to 46 feet, start of unoxidized shale in irregular patches @ 46 feet, B: N74E, 76NW	700
					50		@ 49 feet, B71E, 72NW @ 50 feet, dark grey, unoxidized shale, very hard, few gypsum filled fractures @ 52 feet, unfractured, no gypsum	695
					55		@ 54 feet, B: N71E, 84NW @ 56 feet, B: N80E, 78NW	690
	32.9	75	50/5"	D	60			685
						Total Depth 62.5 feet No water or caving Backfilled with cuttings and tamped		

SAMPLE TYPES		DATE DRILLED:	
<input type="checkbox"/> C	Rock Core	11-18-09	
<input type="checkbox"/> S	Standard Split Spoon	EQUIPMENT USED:	
<input type="checkbox"/> D	Drive Sample	24" Bucket Auger	
<input type="checkbox"/> B	Bulk Sample	GROUNDWATER LEVEL (ft):	
<input type="checkbox"/> T	Tube Sample	Not Encountered	

	PROJECT NO.: 2270.1 HARVARD-WESTLAKE
	LOG OF BORING NO. B-2
FIGURE A-2	

MOISTURE (%)	DRY DENSITY (PCF)	PENETRATION RESISTANCE (BLOWS/FOOT)	SAMPLE TYPE	DEPTH (FEET)	DESCRIPTION OF SUBSURFACE MATERIALS		ELEVATION (FEET)
					This summary applies only at the location of this boring and at the time of drilling. Subsurface conditions may differ at other locations and may change at this location with the passage of time. The data presented is a simplification of actual conditions encountered.		
				0		Fill: SILT (ML) yellow brown and white, diatomaceous silt, with shale debris	
						Monterey Formation: SILTSTONE gray to light brown, very moist, hard, moderately fractured, diatomaceous shale	760
46.2	64	8	D	5		@ 1.5 feet, B: N85E, 68NW @ 6 feet, B: N74E, 63NW, hard, slightly fractured	
							755
33.6	82	5	D	10		@ 10 feet, joint set @ 12" spacing J: NS, 75E B: N72E, 68NW	750
							745
34.0	84	7	D	15		@ 16 feet, B: N62E, 67NW J: N5W, 67NE	745
							740
28.4	87	4	D	20		@ 21 feet, B: N71E, 68NW very hard, few joints, very tight	740
							735
37.7	73	14	D	25		@ 25 feet, B: N72E, 67NW	735
						@ 28 feet, J: N8E, 68SE (tight)	730
84.0	49	20	D	30		@ 33 feet, B: N70E, 73NW	730
						@ 36 feet, J: N8W, 58NE B: N70E, 71NW	725

SAMPLE TYPES

- Rock Core
- Standard Split Spoon
- Drive Sample
- Bulk Sample
- Tube Sample

DATE DRILLED:
11-17-09

EQUIPMENT USED:
24" Bucket Auger

GROUNDWATER LEVEL (ft):
Not Encountered



PROJECT NO.: 2270.1
HARVARD-WESTLAKE

LOG OF BORING NO. B-3

	MOISTURE (%)	DRY DENSITY (PCF)	PENETRATION RESISTANCE (BLOWS/FOOT)	SAMPLE TYPE	DEPTH (FEET)	DESCRIPTION OF SUBSURFACE MATERIALS		ELEVATION (FEET)
						This summary applies only at the location of this boring and at the time of drilling. Subsurface conditions may differ at other locations and may change at this location with the passage of time. The data presented is a simplification of actual conditions encountered.		
	44.7	75	13	D	40			
							@ 43 feet, B: N75E, 74NW	720
	33.4	83	30/9"	D	45		@ 46 feet, J: N18E, 70SE	715
	51.6	70	35	D	50		@ 50 feet, B: N72E, 74NW J: N12W, 63NE	710
	43.6	72	50/11"	D	55		@ 56 feet, J: N8W, 58NE B: N71E, 74NW	705
							@ 57.5 feet, B: N73E, 75NW J: N7W, 60NE	705
	50.3	69	50/10"	D	60			
	52.7	64	50/7"	D				700
							Total Depth 63 feet No water or caving Backfilled with cuttings and tamped	700

SAMPLE TYPES

- C** Rock Core
- S** Standard Split Spoon
- D** Drive Sample
- B** Bulk Sample
- T** Tube Sample

DATE DRILLED:
11-17-09

EQUIPMENT USED:
24" Bucket Auger

GROUNDWATER LEVEL (ft):
Not Encountered



PROJECT NO.: 2270.1
HARVARD-WESTLAKE

LOG OF BORING NO. B-3

	MOISTURE (%)	DRY DENSITY (PCF)	PENETRATION RESISTANCE (BLOWS/FOOT)	SAMPLE TYPE	DEPTH (FEET)	DESCRIPTION OF SUBSURFACE MATERIALS		ELEVATION (FEET)
						This summary applies only at the location of this boring and at the time of drilling. Subsurface conditions may differ at other locations and may change at this location with the passage of time. The data presented is a simplification of actual conditions encountered.		
					0	Fill:		
						SILT (ML) brown, dry, soft, gravelly		
						Colluvium:		
						SILT (ML) dark brown, moist, firm, with white diatomaceous shale fragments		755
	11.2	90	8/5"	D	5	Monterey Formation:		
						SILTSTONE grey to light brown, moist, hard, carbonate bed, blocky fracturing, loose		
						@ 2.5 feet, B: N60E, 60NW		
						@ 3 to 11 feet, moderately-highly fractured/weathered, diatomaceous shale		750
	48.3	62	4	D	10	@ 8 feet, B: N61E, 69NW		
						@ 10 feet, very moist		
						@ 12 feet, diatomaceous shale, very tight, very few fractures/joints		745
	68.6	55	5	D	15	B: N68E, 71NW		
						@ 17 feet, B: N70E, 64NW		740
	67.7	55	4	D	20			
						@ 23 feet, B: N68E, 60NW		735
	88.2	42	20	D	25	@ 26 feet, J: N10E, 47SE		
								730
	104.0	42	28/10"	D	30	@ 32 feet, B: N68E, 66NW		
								725
	98.6	41	10/7"	D	35	@ 37 feet, B: N66E, 65NW		
								720

SAMPLE TYPES
 C Rock Core
 S Standard Split Spoon
 D Drive Sample
 B Bulk Sample
 T Tube Sample

DATE DRILLED:
 11-16-09

EQUIPMENT USED:
 24" Bucket Auger

GROUNDWATER LEVEL (ft):
 Not Encountered

GPI

PROJECT NO.: 2270.1
 HARVARD-WESTLAKE

LOG OF BORING NO. B-4

FIGURE A-4

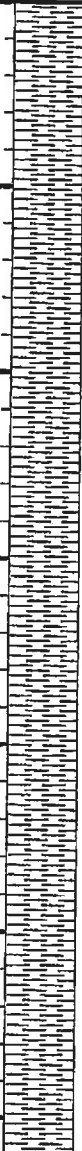
	MOISTURE (%)	DRY DENSITY (PCF)	PENETRATION RESISTANCE (BLOWS/FOOT)	SAMPLE TYPE	DEPTH (FEET)	DESCRIPTION OF SUBSURFACE MATERIALS		ELEVATION (FEET)
						This summary applies only at the location of this boring and at the time of drilling. Subsurface conditions may differ at other locations and may change at this location with the passage of time. The data presented is a simplification of actual conditions encountered.		
	109.6	38	10/6"	D	40			
							@ 42 feet, B: N67E, 65NW J: N11W, 61NE (tight)	715
	104.3	40	26/6"	D	45			
							@ 48 feet, B: N70E, 68NW change to dark grey, unoxidized shale	710
	43.0	74	25/6"	D	50		@ 49 feet, B: N70E, 68NW	
								705
	31.1	83	50/6"	D	55		@ 56 feet, B: N68E, 66NW	
								700
	37.3	72	50/7"	D	60	@ 61 feet, B: N68E, 61NW		
							695	
	63.0	57	20/7"	D	65	@ 66 feet, B: N65E, 58NW J: N9W, 47NE (tight)		
							690	
	83.7	48	20/7"	D	70			
						Total Depth 71 feet No water or caving Backfilled with cuttings and tamped		

SAMPLE TYPES
 C Rock Core
 S Standard Split Spoon
 D Drive Sample
 B Bulk Sample
 T Tube Sample

DATE DRILLED:
 11-16-09

EQUIPMENT USED:
 24" Bucket Auger

GROUNDWATER LEVEL (ft):
 Not Encountered



PROJECT NO.: 2270.1
 HARVARD-WESTLAKE

LOG OF BORING NO. B-4

FIGURE A-4

	MOISTURE (%)	DRY DENSITY (PCF)	PENETRATION RESISTANCE (BLOWS/FOOT)	SAMPLE TYPE	DEPTH (FEET)	DESCRIPTION OF SUBSURFACE MATERIALS		ELEVATION (FEET)
						This summary applies only at the location of this boring and at the time of drilling. Subsurface conditions may differ at other locations and may change at this location with the passage of time. The data presented is a simplification of actual conditions encountered.		
					0	Fill:		
						SILT (ML) brown, dry, soft, horizontal contact with soil, with 3/4" crushed gravel		760
	16.1	74	4	D	5	Residual Soil/Colluvium:		
						CLAYEY SILT (ML)/SILTY CLAY (CL) dark brown, moist, firm, porous, with 10%-20% shale fragments, with roots to 1/2" diameter		755
	58.4	49	12	D	10	Monterey Formation:		
						SILTSTONE whitish and yellow brown, very moist, hard, diatomaceous shale, very few fractures		
						@ 8.5 feet, B: N72E, 65NW		
						@ 10 feet, J: N10W, 75NE		750
						@ 12 feet, B: N71E, 4NW		
						J: N5W, 48NE		
	46.4	58	7/8"	D	15	@ 15 feet, B: N64E, 61NW		
						@ 15.5 feet, J: N12W, 60NE		
						partially open to 1/4" with roots		745
	60.5	56	10/10"	D	20	@ 21 feet, B: N64E, 65NW		740
	45.3	72	13	D	25	@ 25 feet, B: N68E, 63NW		
						J: N65E, 62SE (tight)		735
	50.9	67	12	D	30	@ 30 feet, B: N68E, 64NW		730
	84.0	48	15	D	35	@ 35 feet, B: N70E, 65NW		725
						@ 38 feet, J: N8W, 51NE		

SAMPLE TYPES

- C Rock Core
- S Standard Split Spoon
- D Drive Sample
- B Bulk Sample
- T Tube Sample

DATE DRILLED:

11-17-09

EQUIPMENT USED:

24" Bucket Auger

GROUNDWATER LEVEL (ft):

Not Encountered



PROJECT NO.: 2270.1

HARVARD-WESTLAKE

LOG OF BORING NO. B-5

FIGURE A-5

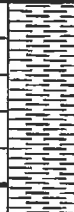
	MOISTURE (%)	DRY DENSITY (PCF)	PENETRATION RESISTANCE (BLOWS/FOOT)	SAMPLE TYPE	DEPTH (FEET)	DESCRIPTION OF SUBSURFACE MATERIALS		ELEVATION (FEET)
						This summary applies only at the location of this boring and at the time of drilling. Subsurface conditions may differ at other locations and may change at this location with the passage of time. The data presented is a simplification of actual conditions encountered.		
	74.5	54	11	D	40		@ 40 feet, B: N69E, 59NW	720
	83.6	47	30/6"	D	45			
						Total Depth 46 feet No water or caving Backfilled		

SAMPLE TYPES

- C Rock Core
- S Standard Split Spoon
- D Drive Sample
- B Bulk Sample
- T Tube Sample

DATE DRILLED:

11-17-09

EQUIPMENT USED:

24" Bucket Auger

GROUNDWATER LEVEL (ft):

Not Encountered



PROJECT NO.: 2270.1

HARVARD-WESTLAKE

LOG OF BORING NO. B-5

FIGURE A-5

	MOISTURE (%)	DRY DENSITY (PCF)	PENETRATION RESISTANCE (BLOWS/FOOT)	SAMPLE TYPE	DEPTH (FEET)	DESCRIPTION OF SUBSURFACE MATERIALS		ELEVATION (FEET)
						This summary applies only at the location of this boring and at the time of drilling. Subsurface conditions may differ at other locations and may change at this location with the passage of time. The data presented is a simplification of actual conditions encountered.		
					0		Monterey Formation: SILTSTONE grey and yellowish white, moist to very moist, hard, diatomaceous shale, laminated to thin bedded, few fractures @ 0.5 feet, B: N71E, 74NW	740
	29.0	75	4	D	5		@ 5 feet, B: N68E, 73NW	735
	38.3	76	9	D	10		@ 8 feet, B: N69E, 68NW @ 10 feet, B: N69E, 68NW	730
					15		@ 14 feet, B: N71E, 72NW	725
							@ 17 feet, B: N70E, 73NW	
	90.7	45	8/7"	D	20		@ 22 feet, B: N71E, 72NW	720
					25		@ 25 feet, B: N71E, 77NW	715
	76.2	47	9	D	30			710
						Total Depth 31 feet No water or caving Backfilled with cuttings and tamped		

SAMPLE TYPES

- C Rock Core
- S Standard Split Spoon
- D Drive Sample
- B Bulk Sample
- T Tube Sample

DATE DRILLED:

11-18-09

EQUIPMENT USED:

24" Bucket Auger

GROUNDWATER LEVEL (ft):

Not Encountered



PROJECT NO.: 2270.1
HARVARD-WESTLAKE

LOG OF BORING NO. B-6

					<i>DESCRIPTION OF SUBSURFACE MATERIALS</i>		ELEVATION (FEET)
					This summary applies only at the location of this boring and at the time of drilling. Subsurface conditions may differ at other locations and may change at this location with the passage of time. The data presented is a simplification of actual conditions encountered.		
MOISTURE (%)	DRY DENSITY (PCF)	PENETRATION RESISTANCE (BLOWS/FOOT)	SAMPLE TYPE	DEPTH (FEET)			
				0	AC Pavement		720
					Fill:		
					CLAYEY SILT (ML) brown, slightly moist, firm, white shale fragments		
					Alluvium/Colluvium:		
18.5	55	2	D	5	CLAYEY SILT (ML) brown, moist, with sand to gravel size white shale fragments, soft, very porous to about 10 feet then less, roots to 1" diameter		715
20.3	54	3	D	10			710
27.0	73	5	D	15			705
43.9	69	3	D	20	Monterey Formation:		700
					SILTSTONE grey to light brown, very moist, very stiff, highly weathered and fractured shale, no continuous bedding		
48.4	71	8	D	25	@ 23 feet, grey to light brown, diatomaceous shale, hard B: N80E, 45NW		695
					@ 25 feet, B: N85E, 44NW		
					@ 27.5 feet, B: N75E, 72NW hard, coherent shale		
50.0	68	6	D	30			690
					Total Depth 31 feet No water or caving		

- SAMPLE TYPES**
- C Rock Core
 - S Standard Split Spoon
 - D Drive Sample
 - B Bulk Sample
 - T Tube Sample

DATE DRILLED:
11-19-09





EQUIPMENT USED:
24" Bucket Auger

GROUNDWATER LEVEL (ft):
Not Encountered



PROJECT NO.: 2270.1
HARVARD-WESTLAKE

LOG OF BORING NO. B-7

	MOISTURE (%)	DRY DENSITY (PCF)	PENETRATION RESISTANCE (BLOWS/FOOT)	SAMPLE TYPE	DEPTH (FEET)	DESCRIPTION OF SUBSURFACE MATERIALS		ELEVATION (FEET)
						This summary applies only at the location of this boring and at the time of drilling. Subsurface conditions may differ at other locations and may change at this location with the passage of time. The data presented is a simplification of actual conditions encountered.		
					0		Fill: CLAYEY SILT (ML) yellow brown, dry, soft, with diatomaceous, shale fragments, roots to 1" diameter, horizontal lower contact	720
	90.7	43	6/7"	D	5		Monterey Formation: BEDROCK white-yellow brown, very moist, hard, diatomaceous shale, thin bedded, few tight fractures/joints @ 3 feet, B: N53E, 73NW @ 8 feet, B: N58E, 69NW	715
	67.1	59	7/10"	D	10		@ 11 feet, B: N61E, 63NW J: N5, 51E	710
					15		@ 15 feet, B: N63E, 67NW	705
	16.1	108	8/7"	D	20			700
						Total Depth 21 feet No water or caving Backfilled with cuttings		

SAMPLE TYPES

- C Rock Core
- S Standard Split Spoon
- D Drive Sample
- B Bulk Sample
- T Tube Sample

DATE DRILLED:

11-18-09

EQUIPMENT USED:

24" Bucket Auger

GROUNDWATER LEVEL (ft):

Not Encountered



PROJECT NO.: 2270.I

HARVARD-WESTLAKE

LOG OF BORING NO. B-8

FIGURE A-8

MOISTURE (%)	DRY DENSITY (PCF)	PENETRATION RESISTANCE (BLOWS/FOOT)	SAMPLE TYPE	DEPTH (FEET)	DESCRIPTION OF SUBSURFACE MATERIALS		ELEVATION (FEET)
					This summary applies only at the location of this boring and at the time of drilling. Subsurface conditions may differ at other locations and may change at this location with the passage of time. The data presented is a simplification of actual conditions encountered.		
				0	 AC Pavement Fill: SILTY CLAY (CL) dark brown, very moist, firm, with whitish shale fragments, sloping contact with bx below dips to N (parallel to hillside)	745	
				5	Monterey Formation: SILTSTONE yellow brown, shaly siltstone, moist, hard, moderately-highly fractured to 8-9 feet then hard, little fractured @ 4.5 feet, N: N85E, 65SE @ 7.5 feet, B: N87E, 66SE less fractured @ 9 feet, discontinuous shear, paper thin S: N33W, 31NE @ 10 feet, B: N86E, 78SE Hard, few fractures @ 13 feet, B: N81W, 79SW very hard, shaly siltstone @ 15 feet, B: EW, 79S hard, diatomaceous shale, very few irregular fractures	710	
				10	@ 19 feet, B: EW, 84S J: N10W, 88SW	705	
				15	@ 22 feet, Darker in color, medium brown, very hard B: EW, 89S J: N10W, 60NE @ 22.5 feet, start of dark grey, unoxidized siltstone in irregular patches @ 25.5 feet, B: N88E, 84SE J: N7W, 78NE @ 26 to 30 feet, very hard, dark grey, unoxidized shaly siltstone	700	
				20		695	
				25		690	
				30	Total Depth 30 feet No samples collected Backfilled with cuttings	685	

SAMPLE TYPES

- C Rock Core
- S Standard Split Spoon
- D Drive Sample
- B Bulk Sample
- T Tube Sample

DATE DRILLED:

12-16-09

EQUIPMENT USED:

24" Bucket Auger

GROUNDWATER LEVEL (ft):









Not Encountered



PROJECT NO.: 2270.1

HARVARD-WESTLAKE

LOG OF BORING NO. B-9

MOISTURE (%)	DRY DENSITY (PCF)	PENETRATION RESISTANCE (BLOWS/FOOT)	SAMPLE TYPE	DEPTH (FEET)	DESCRIPTION OF SUBSURFACE MATERIALS		ELEVATION (FEET)
					This summary applies only at the location of this boring and at the time of drilling. Subsurface conditions may differ at other locations and may change at this location with the passage of time. The data presented is a simplification of actual conditions encountered.		
				0		Natural: Residual soil CLAYEY SILT (ML) dark brown, with shale rock fragments, very moist, soft, porous with roots	740
				5		Monterey Formation: SILTSTONE white chalky diatomaceous shale, laminated/thin bedded, moderately fractured with roots along fractures, hard @ 2 feet, B: N71E, 55SE @ 6 feet, as above, light yellowish brown, shaly siltstone, diatomaceous in part B: N79E, 57SE J: N70W, 56NE	735
				10		@ 9.5 feet, B: N85E, 57SE hard shale, very tight, few fractures @ 13 feet, polished, paper thin clay, parallel bedding, grooves, parallel dip S/B: N89E, 57SE	730
				15		@ 19 feet, B: N84E, 63SE hard diatomaceous shale, little fractures J: N80W, 45NE @ 22 feet, B: N83E, 68SE	725
				20		@ 24.5 feet, 1/2" wide shear zone, disrupts bedding S/F: N15W, 78NE @ 26 feet, B: N87W, 78SW	720
				25		@ 30 feet, hard grey shale, unfractured B: 84E, 82SE @ 32 feet, B: EW, 83S, hard (tight) @ 32 to 35 feet, patches of dark grey, unoxidized shale	715
				30			710
				35		Total Depth 35 feet No water or caving Backfilled; No samples collected	705

SAMPLE TYPES C Rock Core S Standard Split Spoon D Drive Sample B Bulk Sample T Tube Sample	DATE DRILLED: 12-16-09 EQUIPMENT USED: 24" Bucket Auger GROUNDWATER LEVEL (ft): Not Encountered
---	---

	PROJECT NO.: 2270.1 HARVARD-WESTLAKE
LOG OF BORING NO. B-10	
FIGURE A-10	

**PRELIMINARY
GEOTECHNICAL INVESTIGATION
PROPOSED PARKING STRUCTURE
HARVARD-WESTLAKE SCHOOL
3700 COLDWATER CANYON AVENUE
NORTH HOLLYWOOD, CALIFORNIA**

Prepared for:
Innovative Design Group
17848 Sky Park Circle, Suite D
Irvine, California 92614

Prepared by:
Geotechnical Professionals Inc.
5736 Corporate Avenue
Cypress, California 90630
(714) 220-2211

TABLE OF CONTENTS

	PAGE
1.0 INTRODUCTION	1
1.1 GENERAL	1
1.2 PROJECT DESCRIPTION	1
1.3 PURPOSE OF INVESTIGATION	2
2.0 SCOPE OF WORK	3
3.0 SITE CONDITIONS	4
3.1 SURFACE CONDITIONS	4
3.2 SUBSURFACE SOILS	4
3.3 SUBSURFACE SOILS	5
3.4 GROUNDWATER AND CAVING	6
4.0 CONCLUSIONS AND RECOMMENDATIONS	7
4.1 GENERAL	7
4.2 SEISMIC CONSIDERATIONS	8
4.2.1 General	8
4.2.2 Strong Ground Motion Potential	8
4.2.3 Ground Rupture	9
4.2.4 Liquefaction	9
4.2.5 Seismic Ground Subsidence	9
4.3 EARTHWORK	10
4.3.1 Clearing and Grubbing	10
4.3.2 Excavations	10
4.3.3 Subgrade Preparation	11
4.3.4 Material for Fill	12
4.3.5 Placement and Compaction of Fills	13
4.3.6 Shrinkage and Subsidence	13
4.3.7 Trench/Wall Backfill	14
4.3.8 Observation and Testing	14
4.4 SLOPES	14
4.5 FOUNDATIONS	15
4.5.1 Foundation Type	15
4.5.2 Allowable Bearing Pressures	15
4.5.3 Minimum Footing Widths and Embedments	15
4.5.4 Estimated Settlements	16
4.5.5 Lateral Load Resistance	17
4.5.6 Foundation Concrete	17
4.5.7 Footing Excavation Observation	17
4.6 BUILDING FLOOR SLABS	18
4.7 RETAINING STRUCTURES	19
4.7.1 Conventional Retaining Walls	19
4.7.2 Soil Nail Walls	20
4.7.3 Soil Nail Testing	22
4.8 CORROSIVITY	23
4.9 DRAINAGE	24
4.10 EXTERIOR CONCRETE AND MASONRY FLATWORK	24
4.11 PAVED AREAS	24
4.12 GEOTECHNICAL OBSERVATION AND TESTING	25
5.0 LIMITATIONS	26
REFERENCES	
APPENDICES	
A EXPLORATORY BORINGS	
B LABORATORY TESTS	

LIST OF FIGURES

FIGURE NO.

1	Site Location Map
2	Site Plan
3	Geologic Map
4	Geologic Cross-Section A-A'
5	Geologic Cross-Section B-B'
6	Geologic Cross-Section C-C'

APPENDIX A

A-1 to A-10	Logs of Borings
-------------	-----------------

APPENDIX B

B-1	Atterberg Limits Test Results
B-2 to B-9	Direct Shear Test Results
B-10 to B-11	Consolidation Test Results
Table 1	Corrosivity Test Results

1.0 INTRODUCTION

1.1 GENERAL

This report presents the results of a geotechnical investigation performed by Geotechnical Professionals Inc. (GPI) for the proposed parking structure to be located on Coldwater Canyon Avenue at the Harvard-Westlake School in North Hollywood, California. The geographical site location is shown on the Site Location Map, Figure 1.

This report is not intended as a stand-alone document for submittal to the City as a final design document. As discussed in the report, additional information is needed to finalize the detailed design.

1.2 PROJECT DESCRIPTION

Based on a site plan prepared by Innovative Design Group, the proposed development will consist of a new parking structure located within an undeveloped parcel across Coldwater Canyon Avenue from the school's athletic facilities. The parking structure will encroach into an ascending slope adjacent to Coldwater Canyon Avenue. The proposed site configuration is shown on the Site Plan, Figure 2.

The parking structure will be four-levels (3 suspended decks) covering a footprint of approximately 82,047 square feet (sf). We have assumed maximum column loads of up to 700 kips.

The proposed cut adjacent to the parking structure will be supported on three sides with a retaining system independent of the parking structure. The walls are planned to be constructed using top down methods, probably soil nails. The walls will range in height from approximately 10 to 60 feet with a total length on the order of 800 feet.

Based on preliminary grading information provided, the finished floor of the parking structure is planned to range from approximately 5 to 60 feet below the existing site grades.

The finished floor of the parking structure is planned to be approximate 5 feet above the grade of Coldwater Canyon Avenue.

Our recommendations are based upon the above structural and grading information. We should be notified if the actual loads and/or grades change during the project design to either confirm or modify our recommendations. Also, when the project grading and foundation plans become available, we should be provided with copies for review and comment.

1.3 PURPOSE OF INVESTIGATION

The primary purpose of this investigation and report is to provide an evaluation of the existing geotechnical and seismic conditions at the site, as they relate to the design and construction of the proposed construction. More specifically, this investigation was aimed at providing geotechnical recommendations for earthwork, and design of foundations and pavements.

It should be noted that detailed grading and soil nail wall plans will need to be reviewed by GPI prior to confirmation of final design parameters.

2.0 SCOPE OF WORK

Our scope of work for this investigation consisted of field exploration, laboratory testing, engineering analysis, and the preparation of this report.

Our field exploration consisted of ten exploratory borings. The field locations and designations of the subsurface explorations are shown on the Site Plan, Figure 2. The exploratory borings were drilled using truck-mounted, bucket auger equipment to depths ranging from 21 to 71 feet below existing site grades. All borings were downhole logged by a certified engineering geologist. Details of the drilling and Logs of Borings are presented in Appendix A.

Laboratory tests were performed on selected representative soil samples as an aid in soil classification and to evaluate the engineering properties of the soils. The geotechnical laboratory testing program included determinations of moisture content and dry density, grain size distribution, shear strength, compressibility, maximum density/optimum moisture, expansion index, and soil corrosivity. Laboratory testing procedures and results are summarized in Appendix B.

Soil corrosivity testing was performed by Schiff Associates under subcontract to GPI. Their test results are presented at the end of Appendix B.

Geologic evaluations were performed to assess geologic conditions at the site. Engineering evaluations were performed to provide earthwork criteria, foundation and slab design parameters, preliminary pavement sections, and assessments of seismic hazards. The results of our evaluations are presented in the remainder of the report.

3.0 SITE CONDITIONS

3.1 SURFACE CONDITIONS

The proposed area to be developed is located within sloped lots extending upwards from Coldwater Canyon Avenue. The lots contain two residential homes on graded building pads, a larger graded area, driveways, and vacant sloped land. A retaining wall with a height of up to approximately 8 feet runs along a portion of the driveway to the upper vacant building pad. The site is heavily vegetated outside the graded lots with grasses, chaparral, and trees.

The site is bounded on the north by the undeveloped slopes, on the east by Coldwater Canyon Avenue, on the south and west by slopes with residences at the top.

The east facing natural slope extending upward from Coldwater Canyon Avenue has a height of greater than 200 feet. The north facing natural slope has a height of approximately 100 feet to the residence near the top. In general, the slopes have an inclination of steeper than 2:1 (horizontal:vertical). In between these slopes, there exist drainage valleys or fills within former drainage valleys. The topography at the site is shown in Figure 2.

3.2 SUBSURFACE SOILS

Our field investigation disclosed a subsurface profile consisting of undocumented fills underlain by soils and/or bedrock. Fills of less than 5 feet were encountered in our explorations though deeper fills are anticipated at the site. Detailed descriptions of the subsurface conditions encountered are shown on the Logs of Borings in Appendix A. A brief summary is provided below.

The natural soils encountered within the site consist primarily of silty clay, sandy silt, silt, and clayey silt. These soils were encountered within the areas of the current or former drainage valleys. The thickness of native soils in our explorations extended to depths of up to 23 feet below existing grade. These materials range from dry to wet and generally exhibit low strength and high compressibility characteristics.

Bedrock consisting of diatomaceous siltstone was encountered under the undocumented fill and natural soils extending to the depth of the borings. These materials are very moist to wet. These materials generally exhibit moderate to high strength and low to moderate compressibility characteristics.

Expansion Index testing of the siltstone within the parking structure footprint indicated the materials are moderately expansive. Atterberg limits testing of the siltstone indicates a high expansion potential.

3.3 SITE GEOLOGIC CONDITIONS

The project site is located in the Santa Monica Mountains on the west canyon wall of Coldwater Canyon, one of many north-flowing canyons that drain toward the San Fernando Valley. The area is within moderate to steep hillside terrain on the north flank of the east-west trending Santa Monica Mountains.

As shown on Figure 3, a Regional Geologic Map (Reference 1), the site and surrounding area are underlain by sedimentary bedrock of an unnamed shale (Modelo Formation of previous authors) that is typically diatomaceous. The geologic structure of the area is relatively simple, with bedding striking nearly east-west and dipping steeply (60 to 70 degrees) to the north. The geologic map by Dibblee (Reference 1) indicates that a contact between highly diatomaceous shale to the north and thin-bedded siltstone to the south is a depositional sedimentary contact. An AEG Geologic Map (Reference 2) indicates that the contact is a fault contact. Since no shearing or other evidence of faulting was observed in the borings, it is our opinion that the contact is depositional.

Our subsurface investigation consisted of ten large diameter borings that were downhole logged by a registered geologist. The locations of the borings, as well as the geologic data collected, are indicated on the attached Site Plan, Figure 2.

Our geologic investigation generally confirmed the published geology as shown by Dibblee. Bedding generally strikes nearly east-west and dips steeply to the north, except in the extreme southerly portion of the site, where bedding generally steepens, overturns, and dips to the south, as found in Borings B-9 and B-10. No evidence of faulting, such as shearing, was observed in the borings. The geologic map by Dibblee (Reference 1) shows several areas of overturned bedding in areas to the immediate south and east of the site. The bedding reversal is most likely due to simple overturning of steeply dipping bedding.

In general, bedding is favorably oriented with respect to proposed cuts at the toes of east and south facing existing natural slopes. Along a portion of the north facing slope on the south side of the proposed parking structure, steeply dipping bedding will be day-lighted by the proposed cut for the parking structure wall.

The AEG Geologic Map (Reference 2) also indicates a questioned landslide encompassing the ridgeline on the southern portion of the property. Borings B-1, B-2, B-9 and B-10 were drilled specifically to determine whether or not a landslide exists in the area. No evidence of landsliding was found.

Bedrock underlying the site is overlain by clayey, native residual soils and colluvium on the natural hillsides, and fine-grained alluvium, virtually indistinguishable from the colluvial soils, in the east flowing drainage in the southern portion of the site. The maximum thickness of alluvium observed is approximately 23 feet in Boring B-7.

Fill deposits, placed during a previous grading operation of unknown purpose, are present within two east flowing drainages, as shown on the Site Plan, Figure 2. The fill deposits are undocumented and have an estimated maximum thickness of approximately 20 feet. The fills will be removed by the planned cuts for the parking structure.

The interpreted geologic conditions expected to be encountered in the slope areas are indicated on the attached Geologic Cross Sections, Figures 4 to 6.

3.4 GROUNDWATER AND CAVING

Groundwater was not encountered in our exploratory borings to depths of 71 feet below the existing ground surface. Perched groundwater may be encountered within excavations at the bottom of the drainage valleys. A historical depth to groundwater has been determined for the site to be greater than 40 feet below existing grades (Reference 3).

Caving was not observed within the large diameter borings.

4.0 CONCLUSIONS AND RECOMMENDATIONS

4.1 GENERAL

Based on the results of our investigation, it is our opinion that from a geotechnical viewpoint it is feasible to develop the site as proposed. The proposed parking structure can be supported on shallow foundations following remedial grading to mitigate the geotechnical constraints discussed below. The most significant geotechnical issues that will affect the design and construction of the proposed structures are as follows:

- The recommendations provided herein are based on very preliminary design concepts for the project. Until details of the proposed project are available, the recommendations provided herein are subject to revision.
- Due to moderate to high potential for expansion, we recommend that the upper 2 feet of the subgrade soils consisting of siltstone be removed and replaced with imported, non-expansive sandy soils.
- Undocumented fills and compressible soils not removed by the proposed cuts should be removed and replaced as properly compacted fill. At the southeast area of the parking structure, we anticipate deeper excavations to remove compressible alluvium/colluvium will extend to a depth of approximately 20 feet below the finished floor.
- The majority of footings will be supported on competent bedrock. At the southeast area of the parking structure, a limited number of footings will be supported on properly compacted fill. The fill material should be derived from on-site siltstone or suitable import soils. These footings will need to be designed with a reduced bearing capacity relative to footings supported on competent bedrock.
- In order to limit the total and differential settlement of footings, we recommend 2 feet of crushed aggregate base be placed underneath the spread footings with fill depths of 10 feet or greater from the building pad elevation.
- The anticipated locations of footings with reduced bearing capacity should be identified by the Geotechnical Engineer after a foundation plan has been developed and confirmed during pad grading. The anticipated locations of footings required to be underlain with crushed aggregate base should be identified by the Geotechnical Engineer during pad grading.
- As noted in the geologic assessment of the site, the bedding structure in the bedrock encountered in our explorations was noted to be favorably oriented with respect to proposed excavations for the majority of the proposed wall. As such, the stability of excavations extending into the bedrock material is not anticipated to be adversely affected by bedding. We recommend that our geologist be on-site during the excavation to confirm the actual subsurface conditions encountered.

- Steeply sloping bedding may be exposed in the cuts for the soil nail wall. Adverse effects for this condition will be mitigated by the soil nail wall.
- Alluvium/colluvium soils are anticipated to be exposed in the soil nail wall cuts along a portion of the walls for the parking structure. We recommend the soils nails along the wall areas as identified in Section 4.7 of the report utilize the design parameters for alluvium/colluvium.
- The on-site soils are severely corrosive to metals. This should be considered in the design of soil nails and other buried metal. Portland cement products in contact with the on-site soils should be designed for severe levels of soluble sulfate exposure for soil.

Our recommendations related to the geotechnical aspects of the development of the site are presented in the subsequent sections of this report.

4.2 SEISMIC CONSIDERATIONS

4.2.1 General

The site is located in a seismically active area of Southern California and is likely to be subjected to strong ground shaking due to earthquakes on nearby faults.

We assume the seismic design of the proposed development will be in accordance with the California Building Code, 2007 edition. For the 2007 CBC, a Soil Class C may be used. The seismic code values can be obtained directly from the tables in the building code using the above values and appropriate United States Geological Survey web site (Reference 4). The seismic design method should be determined by the Project Structural Engineer.

4.2.2 Strong Ground Motion Potential

Based on published information presented in Reference 5, the most significant fault in the proximity of the site is the Hollywood Fault, which is located approximately 6 kilometers from the site.

During the life of the project, the site will likely be subject to strong ground motions due to earthquakes on nearby faults. Based on our probabilistic ground motion analysis using FRISKSP (Reference 5), the site could be subjected to a peak ground acceleration of 0.56g. This acceleration has a 10 percent chance of being exceeded in 50 years. The ground accelerations are averages of those calculated using attenuation relationships given by Boore, et al (1997), Campbell and Bozorgnia (1997) and Sadigh, et al (1997). The structural design will need to incorporate measures to mitigate the effects of strong ground motion.

4.2.3 Ground Rupture

The site is not located within an Alquist-Priolo Earthquake Fault Zone and there are no known faults crossing or projecting toward the site. Therefore, ground rupture due to faulting is considered unlikely at this site.

4.2.4 Liquefaction

Liquefaction is a phenomenon in which saturated, cohesionless soils undergo a temporary loss of strength during severe ground shaking and acquire a degree of mobility sufficient to permit ground deformation. In extreme cases, the soil particles can become suspended in groundwater, resulting in the soil deposit becoming mobile and fluid-like. Liquefaction is generally considered to occur primarily in loose to medium dense deposits of saturated sandy soils. Thus, three conditions are required for liquefaction to occur: (1) a sandy soil of loose to medium density; (2) saturated conditions; and (3) rapid, large strain, cyclic loading, normally provided by earthquake motions.

The majority of the site is not located within an area identified by the State as having a potential for soil liquefaction. Within this area, soil liquefaction is not likely to occur at the project site because the majority of the soils encountered are sedimentary bedrock and groundwater is deep.

A small portion of the parking structure is located within an area mapped by the State of California as having a potential for soil liquefaction (Reference 3). Groundwater was not encountered to the depth of the bedrock at our exploration (Boring B-7) within the liquefaction zone. Any potentially liquefiable soils within the alluvium and colluvium under the foundations of parking structure will be removed during remedial grading.

4.2.5 Seismic Ground Subsidence

Seismic ground subsidence (not related to liquefaction), occurs when loose, granular (sandy) soils above the groundwater are densified during strong earthquake shaking. Significant subsidence during a strong earthquake is not expected to occur if the recommended earthwork is performed.

4.3 EARTHWORK

The earthwork anticipated at the project site will consist of clearing and grubbing, excavation of undocumented fills, excavation of compressible soils, excavation to pad grade, subgrade preparation, and the placement and compaction of fill.

4.3.1 Clearing and Grubbing

Prior to grading, the areas to be developed should be stripped of any vegetation and cleared of all debris, slabs, and pavements. All buried obstructions, such as footings, underground storage tanks, utilities and tree roots, should be removed.

All deleterious material generated during the clearing operation should be removed from the site. Inert demolition debris, such as concrete and asphalt, may be crushed for re-use in engineered fills in accordance with the criteria presented in the "Material for Fill" section of this report.

Although none were encountered, any cesspools or septic systems encountered during grading should be removed in their entirety. The resulting excavation should be backfilled as recommended in the "Subgrade Preparation" and "Placement and Compaction of Fill" sections of this report. As an alternative, cesspools can be backfilled with a lean sand-cement slurry. At the conclusion of the clearing operations, the representative of the geotechnical engineer should observe and accept the site prior to any further grading.

4.3.2 Excavations

Excavations at this site will include removals of undocumented fill soils, removals of compressible soils, cuts to finish grade, removals of siltstone under the concrete slab, footing excavations, and trenching for proposed utility lines.

Prior to placement of fills, or construction of floor slabs and foundation supported structures, undocumented fills, compressible soils, soils disturbed during demolition, and a portion of the relatively expansive siltstone occurring under the proposed parking structure should be removed and replaced as properly compacted fill. Compressible soils include alluvium, colluvium and residual soils.

Due to their moderate to high expansion potential, we recommend that the siltstone bedrock be excavated to at least 2 feet below proposed finish subgrade under the proposed parking structure and replaced with non expansive fill as described below.

At the southeast area of the parking structure, deeper excavations to remove the compressible alluvium and colluvium soils will be required. We anticipate these excavations to extend to a depth of approximately 20 feet below the finished floor along the eastern wall of the parking structure.

The actual depths of removals should be determined in the field during grading by the Geotechnical Engineer.

The base of the overexcavation for the structures should extend laterally at least 5 feet beyond the building line or perimeter foundations, or a minimum distance equal to the depth of overexcavation/compaction below finish grade (i.e., a 1:1 projection below the top outside edge of footings), whichever is greater. Building lines include all canopies or other foundation supported improvements associated with the parking structure. The corners of the areas to be overexcavated should be accurately staked in the field by the Project Surveyor.

Where not removed by the aforementioned excavations, existing utility trench backfill should be removed and replaced as properly compacted fill. This is especially important for deeper fills associated with existing sewers and storm drains. For planning purposes, removals over the utilities should extend to within 1-foot of the top of the pipe. For utilities, which are 5 feet or shallower, the removal should extend laterally 1-foot beyond both sides of the pipe. For deeper utilities, the removals should include a zone defined by a 1:1 projection upward (and away from the pipe) from each side of the pipe. The actual limits of removal will need to be confirmed in the field. We recommend that all known utilities be shown on the grading plan.

Temporary construction excavations may be made vertically without shoring to a depth of 5 feet below adjacent grade. For cuts up to 10 feet deep within the siltstone, the slopes should be properly shored or sloped back to at least $\frac{3}{4}$:1 or flatter. For cuts up to 20 feet deep within the native soils, the slopes should be properly shored or sloped back to at least $1\frac{1}{2}$:1 or flatter. No surcharge loads should be permitted within a horizontal distance equal to the height of cut from the top of the excavation or 5 feet from the top of the slopes, whichever is greater, unless the cut is properly shored. Excavations that extend below an imaginary plane inclined at 45 degrees below the edge of any adjacent existing site facilities should be properly shored to maintain support of adjacent elements. All excavations and shoring systems should meet the minimum requirements given in the most current State of California Occupational Safety and Health Standards.

4.3.3 Subgrade Preparation

After the recommended removals are performed and prior to placing any fills, the exposed subgrade soils exhibiting near-optimum moisture conditions should be scarified to a depth of 8 inches, moisture-conditioned, and compacted to at least 90 percent of maximum dry density in accordance with ASTM D-1557.

In areas to receive pavements, the upper 12 inches below the pavement base should be scarified, moisture-conditioned, and compacted to dry densities equal to at least 90 percent (95 percent for granular soils) of maximum dry density (ASTM D-1557).

Subgrade processing should not be performed at the bottom of excavations if moist, undisturbed siltstone bedrock conditions are exposed, as determined by GPI in the field during grading. Where siltstone is exposed, care should be taken to prevent it from drying out during construction. Moisture conditioning should be performed on any subgrade soils allowed to dry. Disturbing and recompacting the materials will increase their potential for future expansion.

4.3.4 Material for Fill

The on-site soils are, in general, suitable for use as compacted fill provided they are dried back to near optimum moisture conditions. Beneath the influence of the foundations for the parking structure, the compacted fill should be derived from on-site siltstone or suitable import soils. The on-site siltstone, silts, or clay soils are not suitable for use as retaining wall backfill or under concrete slabs/pavements. We recommend that a minimum of 2 feet of imported, non-expansive, granular fill be used under the slabs for the parking structure. If heaving of exterior flatwork is not tolerable, the same zone of non-expansive materials should be placed under the flatwork.

Retaining wall backfill and select fill below flatwork and slabs should consist of imported granular (containing no more than 40 percent fines – portion passing the No. 200 sieve) and relatively non-expansive (Expansion Index of 20 or less) soils. Moisture conditioning (extensive drying) will be required prior to re-using some of the on-site soils to permit compaction to the recommended degree.

From a geotechnical engineering standpoint, asphalt concrete or portland cement concrete can be incorporated into fills placed outside the building areas provided that they are crushed to the consistency of aggregate base. Such material should not be placed within landscape areas. Provided it is acceptable to the reviewing governmental agencies and owner, crushed, inert demolition debris derived from the existing pavements, may be used in fills with the following processing requirements:

- If the inert debris is crushed to a well graded mixture with maximum particle size of 1½ inches, the crushed material may be used directly in the fill without further blending.
- Inert debris up to a maximum size of 6 inches may also be used in fills, provided it is thoroughly blended with imported sandy soils to form a well graded mixture.

Imported fill material should be predominately granular (contain no more than 40 percent fines - portion passing No. 200 sieve) and non-expansive (E.I. less than 20). The Geotechnical Engineer should be provided with a sample (at least 50 pounds) and notified of the location of any soils proposed for import at least 72 hours in prior to importing. Each proposed import source should be sampled, tested and accepted for use prior to delivery of the soils to the site. Soils imported prior to acceptance by the Geotechnical Engineer may be rejected if not suitable. Both imported and existing on-site soils to be used as fill should be free of debris and should not contain material larger than 6 inches in any dimension.

Both imported and existing on-site soils to be used as fill should be free of debris and should not contain material larger than 6 inches in any dimension.

4.3.5 Placement and Compaction of Fills

Granular (sands and gravels) fill soils should be placed in horizontal lifts, moisture-conditioned, and mechanically compacted to densities equal to at least 95 percent of the maximum dry density, determined in accordance with ASTM D1557. Fills comprised of clayey soils should be compacted to at least 90 percent. Crushed aggregate base beneath the footings to limit settlement should be compacted to at least 98 percent of the maximum dry density in accordance with ASTM D 1557.

The optimum lift thickness will depend on the compaction equipment used and can best be determined in the field. The following uncompacted lift thickness can be used as preliminary guidelines.

Plate compactors	4-6 inches
Small vibratory or static rollers (5-ton)	6-8 inches
Scrapers, heavy loaders, and large vibratory rollers	8-12 inches

The on-site soils include diatomaceous siltstone exhibiting high moisture contents. The grading contractor should anticipate these soils to be moisture sensitive and difficult to compact. The moisture content of the on-site soils is well above optimum, and will require drying. The moisture content of the fill materials should be at least 2 to 3 percent over optimum conditions at the time of compaction. Discing of soils to accelerate drying should be anticipated, if these materials will be used as fill.

The maximum lift thickness should not be greater than 12 inches and each lift should be thoroughly compacted and accepted prior to subsequent lifts.

During backfill of excavations, the fill should be properly benched into the construction slopes as it is placed in lifts.

4.3.6 Shrinkage and Subsidence

Shrinkage is the loss of soil volume caused by compaction of fills to a higher density than before grading. Subsidence is the settlement of in-place subgrade soils caused by loads generated by large earthmoving equipment. For earthwork volume estimating purposes, an average shrinkage value of 10 to 15 percent may be assumed for the surficial soils (upper 5 feet) and alluvium/colluvium soils within the drainage valleys. Subsidence is expected to be less than 0.1 feet. These values are estimates only and exclude losses due to removal of vegetation or debris. Actual shrinkage and subsidence will depend on the types of earthmoving equipment used and should be determined during grading.

4.3.7 Trench/Wall Backfill

Utility trench and wall backfill material should be mechanically compacted in lifts. The clayey soils and siltstone at the site should not be used as retaining wall backfill. Lift thickness should not exceed those values given in the "Compacted Fill" section of this report. Jetting or flooding of backfill materials should not be permitted. The Geotechnical Engineer should observe and test all trench and wall backfills as they are placed.

In backfill areas where mechanical compaction of soil backfill is impractical due to space constraints, sand-cement slurry may be substituted for compacted backfill. The slurry should contain one sack of cement per cubic yard and have a maximum slump of 5 inches. When set, such a mix typically has the consistency of compacted soil. We also recommend that slurry be used as bedding material for trenches containing multiple lines.

4.3.8 Observation and Testing

A representative of GPI should observe all excavations, subgrade preparation, and fill placement activities. Sufficient in-place field density tests should be performed during fill placement and in-place compaction to evaluate the overall compaction of the soils. Soils that do not meet minimum compaction requirements should be reworked and tested prior to placement of any additional fill.

4.4 SLOPES

Natural slopes of varying heights exist above the proposed parking structure and the proposed retaining wall system. The slopes to the south side of the site extend to heights on the order of 100 feet. The slopes to the west and north side of the site extend to heights on the order of 200 feet. The natural slopes above the proposed retaining wall system, as shown in our cross-sections (Figures 4 to 6), have inclinations, in general, of approximately 1.6:1 or flatter.

Preliminary gross stability analysis was performed for the existing slopes using the computer program STABL5M and the Modified Bishop Method of analysis. The surficial stability of the slopes was determined using the method of infinite slope. The soil parameters used were based on direct shear testing of undisturbed and deformed samples.

Existing slopes with favorable bedrock bedding inclined at 1.5:1 were determined to exhibit the minimum generally accepted factors of safety for gross and surficial stability under static and pseudostatic conditions (1.5 and 1.1, respectively).

Existing slopes consisting of colluvium and alluvium at the surface do not have the generally accepted factors of safety for surficial stability under static and pseudostatic conditions (1.5 and 1.1, respectively). This is consistent with observations of creep of the colluvium on the natural soils.

The existing slopes will be modified as part of the construction of the soil nail walls. Details regarding the length of the soil nails will be completed by the wall designer. In addition to internal stability, the wall designer should evaluate the global stability of the slopes as the

length of the nails determines the stability of the slopes. The modified slopes should be evaluated as part of the review of the wall and grading plans.

Construction within the slopes should be observed by our geologist to confirm the subsurface conditions, especially with respect to adverse bedding, are consistent with our findings.

Fill slopes may be constructed at inclinations of 2:1 (horizontal:vertical) or flatter.

4.5 FOUNDATIONS

4.5.1 Foundation Type

The proposed structure may be supported on conventional isolated and/or continuous shallow footings, provided the subsurface soils are prepared in accordance with the recommendations given in this report. All footings for the parking structure should be supported on competent bedrock and/or properly compacted fill. Footing bottoms should be moistened immediately prior to placement of concrete.

4.5.2 Allowable Bearing Pressures

Based on the shear strength and elastic settlement characteristics of the natural and recompacted on-site soils, static allowable net bearing pressures of up to 6,000 pounds per square foot (psf) may be used for both continuous footings and isolated column footings for the proposed parking structure. These bearing pressures are for dead-load-plus-live-load, any may be increased one-third for short-term, transient, wind and seismic loading. The actual bearing pressure used may be less than the value presented above and can be based on economics and structural loads to determine the minimum width for footings as discussed below. The maximum edge pressures induced by eccentric loading or overturning moments should not be allowed to exceed these recommended values.

4.5.3 Minimum Footing Widths and Embedments

The following minimum footing widths and embedments are recommended for the corresponding allowable bearing pressure.

MINIMUM FOOTING WIDTHS AND EMBEDMENTS

STATIC BEARING PRESSURE (psf)	MINIMUM FOOTING WIDTH (inches)	MINIMUM FOOTING* EMBEDMENT (inches)
Footings Supported on Competent Bedrock		
6,000	60	36
4,000	48	24
3,000	24	24
2,500	18	18
Footings Supported on Properly Compacted Fill		
5,000	60	36
3,000	48	24
2,000	24	24
1,500	18	18

* Refers to minimum depth below lowest adjacent grade at the time of foundation construction.

A minimum footing width of 18 inches should be used even if the actual bearing pressure is less than 1,500 psf.

To achieve a bearing pressure of 6,000 psf, deepening of footings locally to bedrock may be required.

The majority of footings will be supported on competent bedrock. The locations of footings anticipated to be supported on properly compacted fill should be identified by the Geotechnical Engineer after a foundation plan has been developed and should be confirmed during the grading of the building pad.

Footings adjacent to the descending slope along Coldwater Canyon Avenue should be deepened to allow for a lateral distance of at least one-half of the slope height, but not less than 10 feet, between the base of the footing and the face of the slope. We should be provided with the foundation and grading plans to review the footing conditions relative to the proposed adjacent grades prior to bidding the project.

4.5.4 Estimated Settlements

For the parking structure, total static settlement of the column footings (700 kips maximum column load) is expected to be less than 1.5 inches provided the footings are supported on competent bedrock or properly compacted fills.

In order to limit the total settlement to 1.5 inches, we recommend 2 feet of crushed aggregate base be placed underneath the spread footings with fill depths of 10 feet or greater from the building pad elevation. The crushed aggregate base beneath footings should extend beyond the edge of footings at least a distance equal to the thickness of the base. The crushed aggregate base should be placed as recommended in the "Placement and Compaction of Fills" section of this report.

The actual footings requiring to be underlain with crushed aggregate base to limit settlements should be determined in the field during grading by the Geotechnical Engineer.

Provided the above recommendations concerning the placement of crushed aggregate base under footings supported on deeper fills are incorporated into the project plans and placed during construction, the maximum differential settlements between similarly loaded adjacent footings or along a 60-foot span are expected to be less than $\frac{3}{4}$ -inch.

The above estimates are based on the assumption that the recommended earthwork will be performed and that the footings will be sized in accordance with our recommendations.

4.5.5 Lateral Load Resistance

Soil resistance to lateral loads will be provided by a combination of frictional resistance between the bottom of footings and underlying soils and by passive soil pressures acting against the embedded sides of the footings. For frictional resistance, a coefficient of friction of 0.35 may be used for design. In addition, an allowable lateral bearing pressure equal to an equivalent fluid weight of 300 pounds per cubic foot may be used for footings. The allowable lateral bearing pressure values provided are based on the footings being poured tight against compacted fill or competent bedrock. The friction and lateral bearing values may be used in combination without reduction.

4.5.6 Foundation Concrete

Laboratory testing by Schiff Associates (Appendix B) on a samples provided by GPI indicates soluble sulfate content of 1,080 and 5,220 mg/kg (0.11 and 0.52 percent by weight). Foundation concrete should conform to the requirements outlined in ACI 318, Section 4.3, for severe levels of soluble sulfate exposure for soil.

4.5.7 Footing Excavation Observation

Prior to placement of steel and concrete, a representative of GPI should observe and approve all footing excavations.

4.6 BUILDING FLOOR SLABS

Slab-on-grade floors should be supported on a minimum of 24 inches of granular non-expansive (Expansion Index less than 20), compacted soils as discussed in the "Placement and Compaction of Fill" section. The on-site siltstone, silt, or clay should not be permitted within 24 inches of the concrete slab.

While not anticipated over the majority of the parking structure floor, a vapor/moisture retarder should be placed under any slabs that are to be covered with moisture-sensitive floor coverings (parquet, vinyl tile, etc.). Currently, common practice is to use 10-mil polyethylene as a vapor retarder placed either directly on the subgrade or over a thin layer of sand. Recently, other types of vapor retarders with much lower permanence and higher puncture resistance have become available and should be considered as an alternative. Polyolefin in 10-mil or 15-mil thickness is such a material and could be considered for this project. This material should be covered by a layer of clean sand (less than 5 percent by weight passing the No. 200 sieve) having a minimum thickness of 2 inches. The function of the sand layer is to protect the vapor retarder during construction and to aid in the uniform curing of the concrete. This layer should be nominally compacted using light equipment. The sand placed over the vapor barrier should be only slightly moist. If the sand gets wet (for example, as a result of rainfall) it must be allowed to dry prior to placing concrete.

It should be noted that the material used as a vapor retarder is only one of several factors affecting the prevention of moisture accumulation under floor coverings. Other factors include effective sealing of joints edges (particularly at pipe penetration) as well as excess moisture in the concrete. The manufacturer of floor coverings should be consulted for establishing acceptable criteria for the condition of floor surface prior to placing moisture-sensitive floor coverings.

For lateral resistance design, a coefficient of friction of 0.4 can be used for concrete in direct contact with sandy fill. For slabs constructed over a visqueen or polyolefin moisture barrier, a friction coefficient of 0.1 should be used.

4.7 RETAINING STRUCTURES

At the time this report was prepared, building basement walls were not planned for the project. The cut behind the parking structure is planned to be supported by an independent retaining system. The following recommendations are provided for soil nail walls, the planned retaining wall system outside of the parking structure, and conventional retaining walls for ramp walls and small site walls.

We should be provided with the design plans retaining systems prior to finalizing to confirm suitable geotechnical design parameters have been used.

4.7.1 Conventional Retaining Walls

Active earth pressures can be used for designing cantilevered walls up to 15 feet in height that can yield at least ½-inch laterally in 10 feet under the imposed loads. For cantilever walls with level backfill comprised of granular soils, the magnitude of active pressures are equivalent to the pressures imposed by a fluid weighing 35 pounds per cubic foot (pcf). For sloping backfill with a 2:1 inclination, the active pressure would be about 52 pcf.

For restrained walls that remain rigid enough to be essentially non-yielding, an at-rest lateral earth pressure should be used for design. For restrained walls with level backfill comprised of granular soils, the magnitude of at-rest pressure is equivalent to the pressure imposed by a fluid weighing 52 pounds per cubic foot (pcf).

Walls subject to surcharge loads should be designed for an additional uniform lateral pressure equal to one-third and one-half the anticipated surcharge pressure for unrestrained and restrained walls, respectively. We can provide more specific lateral earth pressures resulting from surcharge loads when further details on the surcharge load are available.

The recommended pressures are based on the assumption that the supported earth will be fully drained, preventing the build-up of hydro-static pressures. For traditional backfilled retaining walls, a drain consisting of perforated pipe surrounded by gravel and wrapped in filter fabric should be used. As a minimum, one cubic foot of rock should be used for each lineal foot of drain. The fabric (non-woven filter fabric, Mirafi 140N or equivalent) should be lapped at the top.

The Structural Engineer should specify the use of select, granular wall backfill on the plans for conventional retaining walls. Wall footings should be designed as discussed in the "Foundations" section.

4.7.2 Soil Nail Walls

We understand that soil nail walls will probably be used for retaining the cuts up to 60 feet outside of the parking structure. The soil nail walls consist of steel bar encased in grout constructed from the top down in increments and completed with a wire mesh and shotcrete surface.

We expect that a specialty contractor will be retained to develop a soil nail wall design and construction plan on a design-build basis. A soil nail wall should be designed using soil strengths that reflect the condition of the retained materials behind the wall. Based on our explorations, it appears that the wall will retain mainly siltstone materials and to a lesser extent alluvium/colluvium and existing fill. The actual conditions should be observed in the field during construction by a representative of GPI to confirm the actual conditions.

Provisions should be made by the soil nail design engineer to modify the nail lengths as needed during construction to accommodate changes in ground conditions. For design of the nails, we recommend the following design parameters:

Preliminary Soil Nail Design Parameters

Moist Unit Weight, pcf	Cohesion, psf	Phi angle, degrees
Siltstone Bedrock		
90	200	30
Alluvium/Colluvium/Existing Fill		
100	100	28

We anticipate alluvium/colluvium soils to be exposed in the soil nail wall cuts along a portion of the wall on the west side of the parking structure and along the diagonal wall facing the southeast. We anticipate the alluvium/colluvium will be exposed from the southwest corner of the parking structure for approximately 100 feet to the north. We anticipate the alluvium/colluvium will be exposed along the entire portion of the diagonal wall facing the southeast. We recommend the alluvium/colluvium be assumed to extend a depth of 20 feet from the top of the proposed wall in these areas.

The areas where alluvium/colluvium design parameters should be used in the wall design is shown on Figure 2. We recommend that our geologist be on-site during the excavation to confirm the actual subsurface conditions encountered during the excavations for the soil nail walls.

The soil nail wall should be designed for seismic conditions. We recommend a pseudostatic coefficient of one-half of the peak ground acceleration provided in the "Strong Ground Motion" section of this report be used in the design of the soil nail wall.

The design should include consideration of global stability of the cut as well as internal stability. The retaining wall designer should confirm the global stability of the cut by evaluating potential failures beyond the soil nails. **The nails should have sufficient length whereas potential failure surfaces extending beyond the soil nails and the toe**

of the planned wall have an adequate factor of safety for the global stability. The global stability should have a factor of safety of at least 1.5 and 1.1 for static and seismic conditions, respectively.

We should review the soil nail plans and analyses for global stability. During our review, we will only confirm soil strength design parameters.

For design of soil nail walls, a design bond stress between the soil nail grout and the surrounding soil is needed to perform internal wall stability calculations. An ultimate bond stress values of 12 psi in the siltstone and 10.0 psi in the colluvium/alluvium soils may be used, assuming that the average depth to the grouted portion of the soil nail is at least 20 feet below finish grades. The values may be increase if the average depth to the grouted portion of the soil nail is significantly deeper than 20 feet. These conditions can be evaluated at the time of the final design of the wall. Considering the large number of soil nails to be installed, we recommend installation and load testing of several pre-production test nails (in alluvium/colluvium and siltstone) in order to confirm/refine the bond stresses listed above. Details of soil nail testing are presented in the subsequent section of this report.

The upper 10 feet of the wall adjacent to streets or drives should be designed to resist a uniform lateral pressure of 100 pounds per square foot, acting as a result of an assumed 300 pound per square foot surcharge behind the wall due to normal street traffic. If traffic is kept at least 10 feet from the wall, the traffic surcharge may be neglected.

The soil nail contractor should evaluate the potential drilling conditions when planning the installation methods. Caving was not encountered during our explorations at the upper portion of the site in the area of the planned cut. However, some loose, dry materials may be encountered in the near-surface alluvium/colluvium and may be prone to local caving.

The soil nails should be designed for soils severely corrosive to metals. The grout in the soil nails should be designed for severe levels of soluble sulfate exposure for soil.

The permanent walls should be drained full-height using a suitable drainage composite. The drainage composite should be placed between the soil nails prior to applying the shotcrete surface to allow for perched groundwater seepage within the height of the cut to be collected and discharged without building up hydrostatic pressures behind the wall. We recommend that the continuous drainage panels be installed at the same spacing as the soil nails. Sufficient drainage should be provided to accommodate existing outlet drains from the backdrain of the slope stabilization fill.

We recommend performing a detailed survey of the improvements supported above the planned cut prior to and during the soil nail installation. The survey should include topographic data and a video account of the condition of the existing improvements, including cracks or signs of distress. During construction, the monitoring should consist of periodic surveying of the lateral and vertical locations of the top of the soil nail wall. We suggest weekly readings for the first four weeks after installation. After that time, the readings should be performed twice-monthly until the completion of the construction.

4.7.3 Soil Nail Testing

We recommend the contractor perform proof and verification testing on the soil nails. The following soil nail testing procedures are in general accordance with FHWA guidelines (Reference 6).

Proof tests should be performed on production nails at locations approved by the Geotechnical Engineer. We recommend at least 5 percent of the total nails in each row should be selected for proof testing. This should include at least 1 nail per row and 1 nail per distinct soil/rock unit for proof testing. We recommend pre-production verification tests should be performed on at least two sacrificial test nails in each different soil/rock unit and for each different drilling/grouting method.

The test nails should have both bonded and temporary unbonded lengths. Prior to testing only the bonded length of the test nail shall be grouted. The temporary unbonded length of the test nail should be at least 3 feet.

We recommend the verification tests be performed by incrementally loading the test nail to a maximum test load of 200 percent of the Design Test Load (DTL). The DTL is determined by multiplying the as-built bonded test length (feet) by the allowable pullout resistance of the nail (kips per foot of grouted nail length). After loading the nail to an alignment load (0.10DTL), the loads should be increased to 0.25DTL and subsequent load increments of 0.25DTL. At load increments below 1.5DTL, the load shall be held a sufficient time increment to obtain a stable reading. At 1.5DTL, the load shall be held for 60 minutes for a creep test. The nail movement during the creep test shall be measured and recorded at 1, 2, 3, 5, 6, 10, 20, 30, 40, 50, and 60 minutes. After the creep test, the nail shall be loaded to 1.75 DTL and 2.0 DTL for a sufficient time increment to obtain a stable reading.

For verification tests, the test nail may be considered acceptable when a total creep movement of less than 0.08 inch per log cycle of time between the 6 and 60 minute readings is measured during creep testing and the creep rate is linear or decreasing throughout the creep test load hold period.

We recommend the proof tests be performed by incrementally loading the test nail to a maximum test load of 150 percent of the DTL. After loading the nail to an alignment load (0.10DTL), the loads should be increased to 0.25DTL and subsequent load increments of 0.25DTL. At load increments below 1.5DTL, the load shall be held a sufficient time increment to obtain a stable reading. At 1.5DTL, the load shall be held for 60 minutes for a creep test. The nail movement during the creep test shall be measured and recorded at 1, 2, 3, 5, 6, and 10 minutes. If the nail movement between 1 minute and 10 minutes exceeds 0.04 inches, the maximum test load shall be maintained an additional 50 minutes and the movements shall be recorded at 20, 30, 50, and 60 minutes.

The test nails during proof testing may be considered acceptable when the following have been achieved:

- A total creep movement of less than 0.04 inch measured between the 1 and 10 minute readings or a total creep movement of less than 0.08 inch is measured between the 6 and 60 minute readings and the creep rate is linear or decreasing throughout the creep test load hold period.
- The total measured movement at the maximum test load exceeds 80 percent of the theoretical elastic elongation of the test nail unbonded length.
- A pullout failure does not occur at the maximum test load. Pullout failure is defined as the load at which attempts to further increase the test load simply result in continued pullout movement of the test nail. The pullout failure load shall be recorded as part of the test data.

Nails meeting the above proof-testing acceptance criteria may be incorporated as production nails after being completed by grouting the unbonded test length.

If a test nail does not meet the acceptance criterion, the Contractor should determine the cause of the problem. The Geotechnical Engineer may require the installation and testing of additional proof test nails to verify that adjacent previously installed production nails have sufficient load carrying capacity. The Contractor may be required to modify design or construction procedures. The modifications may include the installation of additional proof test nails, increasing the drillhole diameter, modifying the installation or grouting methods, reducing the production nail spacing, or installing longer production nails. Lengthening of the nails may be limited by the temporary construction easements or the permanent right-of-way.

Nail testing should be performed by the Contractor and observed by GPI. The Contractor should provide all necessary test equipment, including an independent fixed reference point (i.e., tripod) for placement of the digital or dial gauge for measuring nail deflections during testing. Prior to testing, the Contractor should supply current calibration records of the hydraulic jack and pressure gauge to be used for testing. Calibration records should be signed by a California registered professional engineer and be within 9 months prior of the start of testing.

We recommend that a representative of GPI observe the installation and testing of all soil nails to confirm that the recommendations provided in our report are applicable during construction.

4.8 CORROSIVITY

Resistivity testing of a sample of the on-site soils indicates that the on-site soils and bedrock are severely corrosive to metals. We do not practice corrosion protection engineering. If buried metal pipe is to be used, a corrosion engineer such as Schiff Associates should be consulted.

4.9 DRAINAGE

Positive surface gradients should be provided adjacent to all structures so as to direct surface water run-off and roof drainage away from foundations and slabs toward suitable discharge facilities. Long-term ponding of surface water should not be allowed on pavements or in planters adjacent to buildings.

4.10 EXTERIOR CONCRETE AND MASONRY FLATWORK

If heaving of exterior flatwork is not tolerable, diatomaceous siltstone, silt, or clay within 24-inches of the flatwork or concrete pavements adjacent to the parking structure should not be permitted and the exterior flatwork should be supported on non-expansive, compacted fill. Prior to placement of concrete, the subgrade should be prepared as recommended in "Subgrade Preparation" section.

4.11 PAVED AREAS

Although significant paved areas are not anticipated for the project, preliminary pavement sections are provided below based upon an assumed R-value of 20 and conventional Traffic Indices (TI's) typically used for commercial developments. The California Division of Highways Design Method was used for design of the recommended preliminary pavement sections. These recommendations are based on the assumption that the pavement subgrades will consist of existing near-surface soils. Final pavement design should be based on R-value testing performed near the conclusion of rough grading. The following pavement sections are recommended for planning purposes only.

PAVEMENT AREA	TRAFFIC INDEX	SECTION THICKNESS (inches)	
		ASPHALT CONCRETE	AGGREGATE BASE COURSE
Asphalt Concrete Auto Parking Stalls	4	3	5
Circulation Drives (no trucks)	5	3	8
Truck Driveways	6	3	11
Portland Cement Concrete Auto Parking Stalls	4	Portland Cement Concrete 7	----
Circulation Drives (no trucks)	5	7	----
Truck Driveways	6	7½	----

The concrete used for paving should have a modulus of rupture of at least 550 psi (equivalent to an approximate compressive strength of 3,700 psi at the time the pavement is subjected to traffic).

The pavement subgrade underlying the aggregate base should be properly prepared and compacted in accordance with the recommendations outlined under "Subgrade Preparation".

The pavement base course should be compacted to at least 95 percent of the maximum dry density (ASTM D 1557). Aggregate base should conform to the requirements of Section 26 of the California Department of Transportation Standard Specifications for Class II aggregate base (three-quarter inch maximum) or Section 200-2 of the Standard Specifications for Public Works Construction (Green Book) for untreated base materials (except processed miscellaneous base).

The above recommendations are based on the assumption that the upper 24-inches of expansive soils below concrete pavements have been removed and replaced with non-expansive material.

The above recommendations are based on the assumption that the base course and compacted subgrade will be properly drained. The design of paved areas should incorporate measures to prevent moisture build-up within the base course, which can otherwise lead to premature pavement failure. For example, curbing adjacent to landscaped areas should be deep enough to act as a barrier to infiltration of irrigation water into the adjacent base course.

4.12 GEOTECHNICAL OBSERVATION AND TESTING

We recommend that a representative of GPI observe all earthwork during construction to confirm that the recommendations provided in our report are applicable during construction. The earthwork activities include soil nail wall construction, grading, compaction of fills, subgrade preparation, pavement construction and foundation excavations. If conditions are different than expected, we should be afforded the opportunity to provide an alternate recommendation based on the actual conditions encountered.

5.0 LIMITATIONS

The report, exploration logs, and other materials resulting from GPI's efforts were prepared exclusively for use by Innovative Design Group and their consultants in designing the proposed development. The report is not intended to be suitable for reuse on extensions or modifications of the project or for use on any project other than the currently proposed development, as it may not contain sufficient or appropriate information for such uses. If this report or portions of this report are provided to contractors or included in specifications, it should be understood that they are provided for information only. This report cannot be utilized by another entity without the express written permission of GPI. This report is an instrument of our services and remains the property of GPI.

Soil deposits may vary in type, strength, and many other important properties between points of exploration due to non-uniformity of the geologic formations or to man-made cut and fill operations. While we cannot evaluate the consistency of the properties of materials in areas not explored, the conclusions drawn in this report are based on the assumption that the data obtained in the field and laboratory are reasonably representative of field conditions and are conducive to interpolation and extrapolation.

Furthermore, our recommendations were developed with the assumption that a proper level of field observation and construction review will be provided during grading, excavation, and foundation construction by GPI. If field conditions during construction appear to be different than is indicated in this report, we should be notified immediately so that we may assess the impact of such conditions on our recommendations. If construction phase services are performed by others they must accept full responsibility (as Project Geotechnical Engineer) for all geotechnical aspects of the project including this report.

Our investigation and evaluations were performed using generally accepted engineering approaches and principles available at this time and the degree of care and skill ordinarily exercised under similar circumstances by reputable Geotechnical Engineers practicing in this area. No other representation, either expressed or implied, is included or intended in our report.

Respectfully submitted,
Geotechnical Professionals Inc

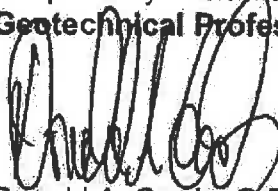
Donald A. Cords, G.E.
Associate

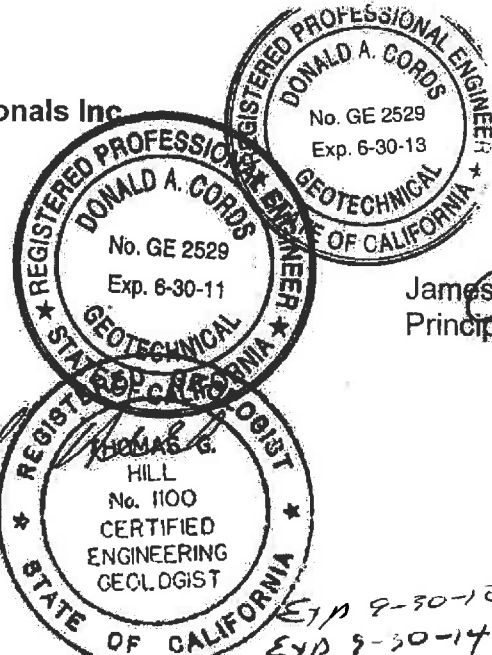



James E. Harris, G.E.
Principal

Professional Engineer stamps for James E. Harris (No. GE 2100, Exp. 12-31-11) and another for James E. Harris (No. GE 2100, Exp. 12-31-13). The stamps are circular and include the text "REGISTERED PROFESSIONAL ENGINEER" and "STATE OF CALIFORNIA".

EXPIRE 9-30-10
EXPIRE 9-30-14
2/13/13

REFERENCES

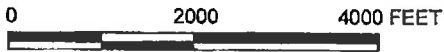
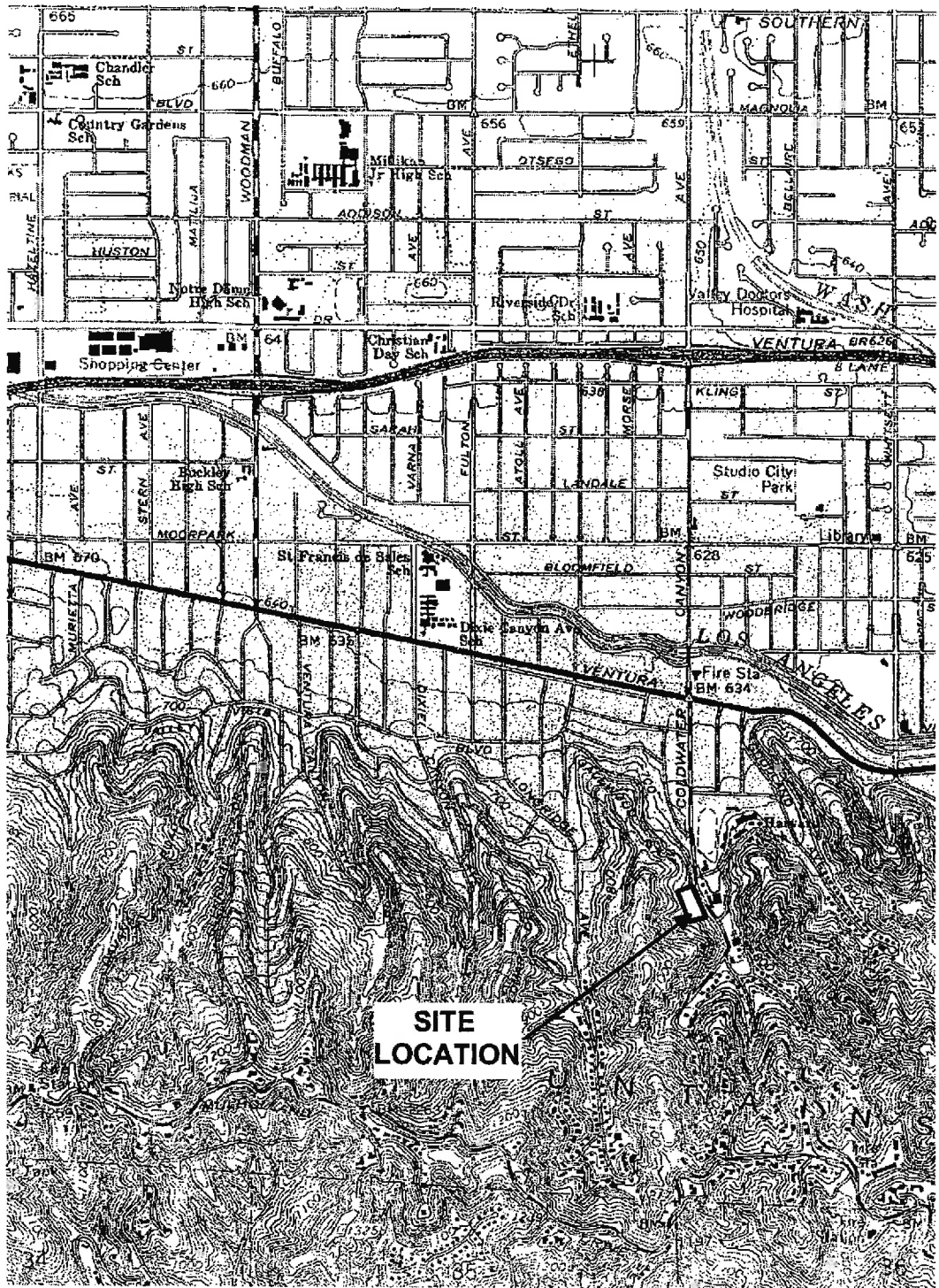
1. Dibblee, T.W., Jr., 1991, Geologic Map of the Beverly Hills and Van Nuys (south ½) Quadrangles. Dibblee Geological Foundations Map #DF-31; Scale, 1:24,000.
2. AEG, 1982, Geologic Maps, Santa Monica Mountains, Compiled by Bureau of Engineering, Department of Public Works, City of Los Angeles, Book of Geologic Maps; Scale 1:48,000.
3. California Department of Conservation, Division of Mines and Geology (1997), "Seismic Hazard Zone Map for the Van Nuys 7.5-Minute Quadrangle, Los Angeles County, California," Updated June 2005.
4. United States Geological Survey, "Seismic Design Values for Buildings, Seismic Hazard Mapping, Research and Monitoring, Website Address: <http://earthquake.usgs.gov/research/hazmaps/design/index.php>.
5. Blake, T.F. (2000), "FRISKSP, A Computer Program for the Probabilistic Estimation of Uniform-Hazard Spectra Using Faults as Earthquake Sources," Version, 4.00.
6. FHWA, "Appendix B1, FHWA Guide Specification for Permanent Soils Nails and Wall Excavation, Manual for Design and Construction Monitoring of Soil Nail Walls," FHWA Publication No. FHWA-SA-96-069, November 1996.



BASE MAP REPRODUCED FROM VAN NUYS QUADRANGLE FROM USGS MAPS



GEOTECHNICAL
PROFESSIONALS, INC.

HARVARD WESTLAKE

GPI PROJECT NO. 2270.1

SCALE: 1" = 2000'

SITE LOCATION

FIGURE 1



CLAYTON HILLS
 This formation consists of... (Detailed description of Clayton Hills formation)

MONTEFET FORMATION
 This formation consists of... (Detailed description of Montefet formation)

UNCONFORMITY

UPPER TORANGA FORMATION
 This formation consists of... (Detailed description of Upper Toranga formation)

HUMBOLDT VOLCANIC SERIES
 This series includes... (Detailed description of Humboldt volcanic series)

LOWER TORANGA FORMATION
 This formation consists of... (Detailed description of Lower Toranga formation)

SANTA LUCIANA FORMATION
 This formation consists of... (Detailed description of Santa Luciana formation)

GEOLGY MAP FROM DIBBLEE (REFERENCE 1)

REGIONAL GEOLOGIC MAP

FIGURE 2



GEOTECHNICAL PROFESSIONALS, INC.
 HARVARD WESTLAKE
 GPI PROJECT NO.: 22701 SCALE: 1" = 1500'



SITE LOCATION



EXPLANATION

- A_1 FILL (INDICATED BY DASHES)
- T_1 MONTPELIER FORMATION
- Q_1/Q_2 ALLUVIUM/COLLUVIUM
- B/S BOREHOLE (PI 1000)
- 2'—12' STRIKE AND DIP OF BEDDING, DEPTH INDICATED WHERE SURFACE
- 20'—30' STRIKE AND DIP OF JOINT, DEPTH INDICATED WHERE SURFACE
- 3'—31' STRIKE AND DIP OF SHEAR OR FAULT, DEPTH INDICATED
- GEOLOGICAL CONTACT
- GEOLOGIC SECTIONS
- +700 PROPOSED FINISHED FLOOR ELEVATION OF PARKING STRUCTURE
- PROPOSED SOIL WALL AREA TO BE DESIGNED FOR ALLTERRACOLLUVIUM

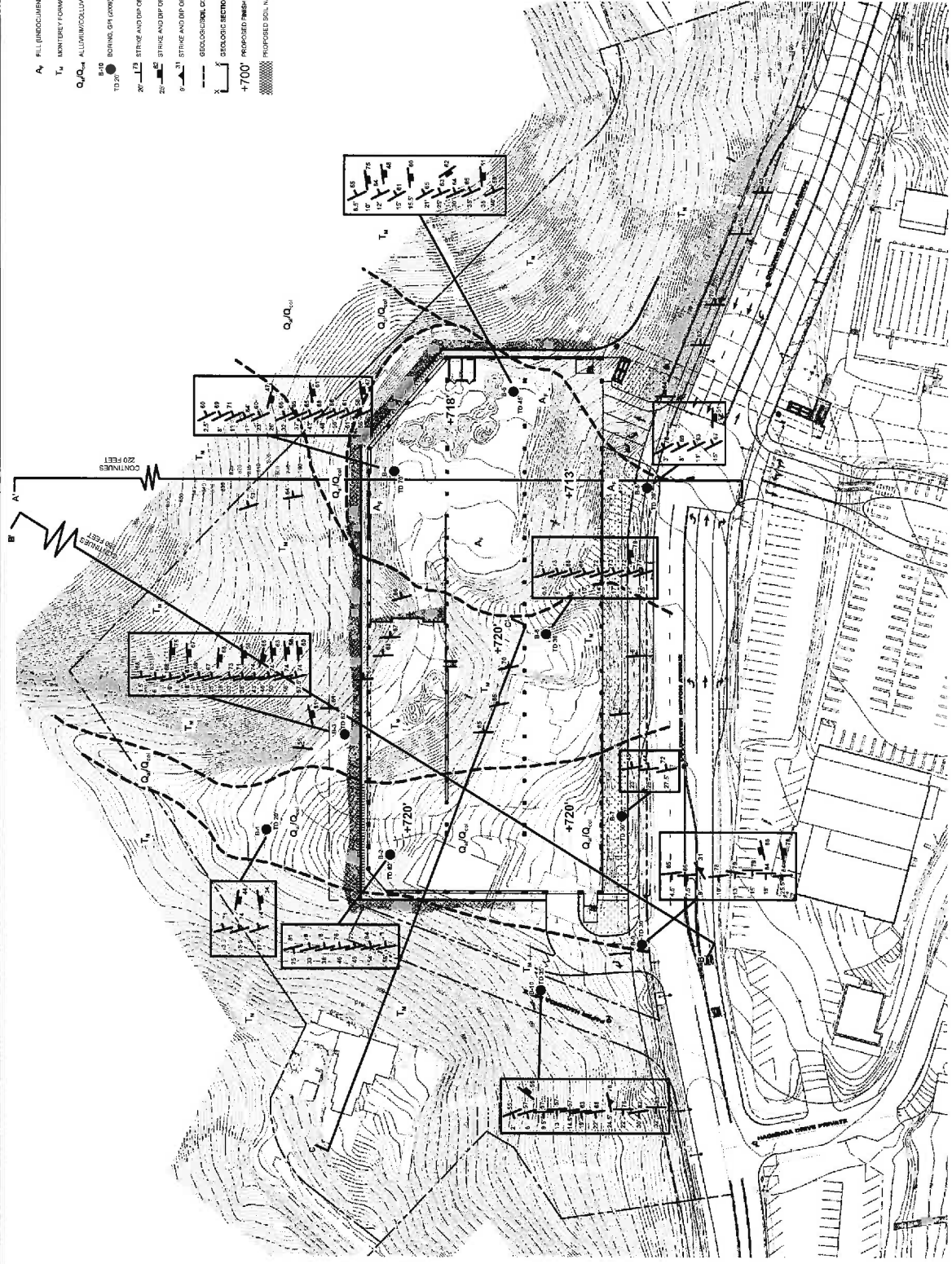

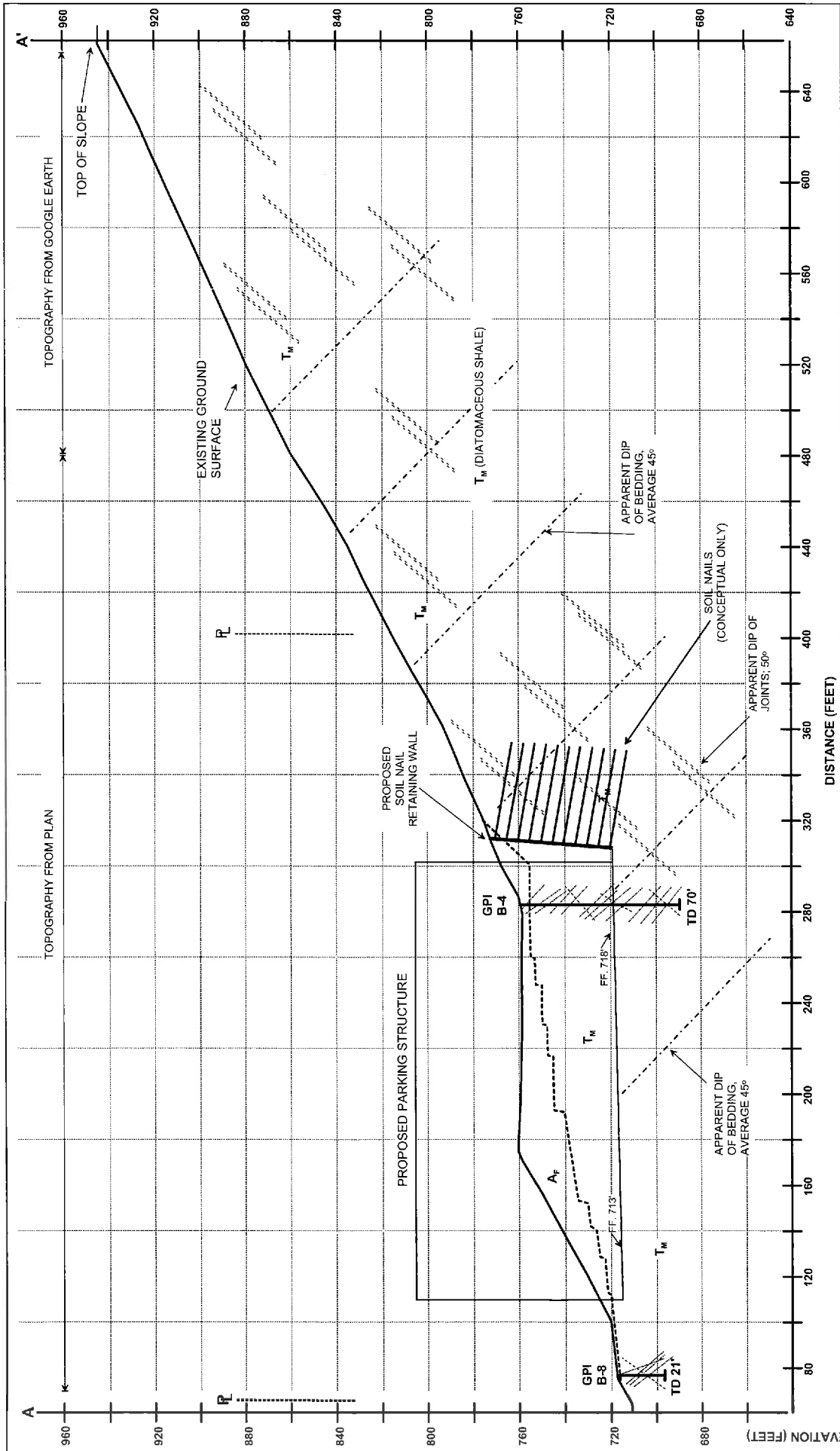

GPI GEOTECHNICAL PROFESSIONALS, INC.

IDG - HARVARD WESTLAKE

GPI PROJECT NO. 22701

SCALE: 1" = 40'

CROSS SECTION A-A'

FIGURE 4

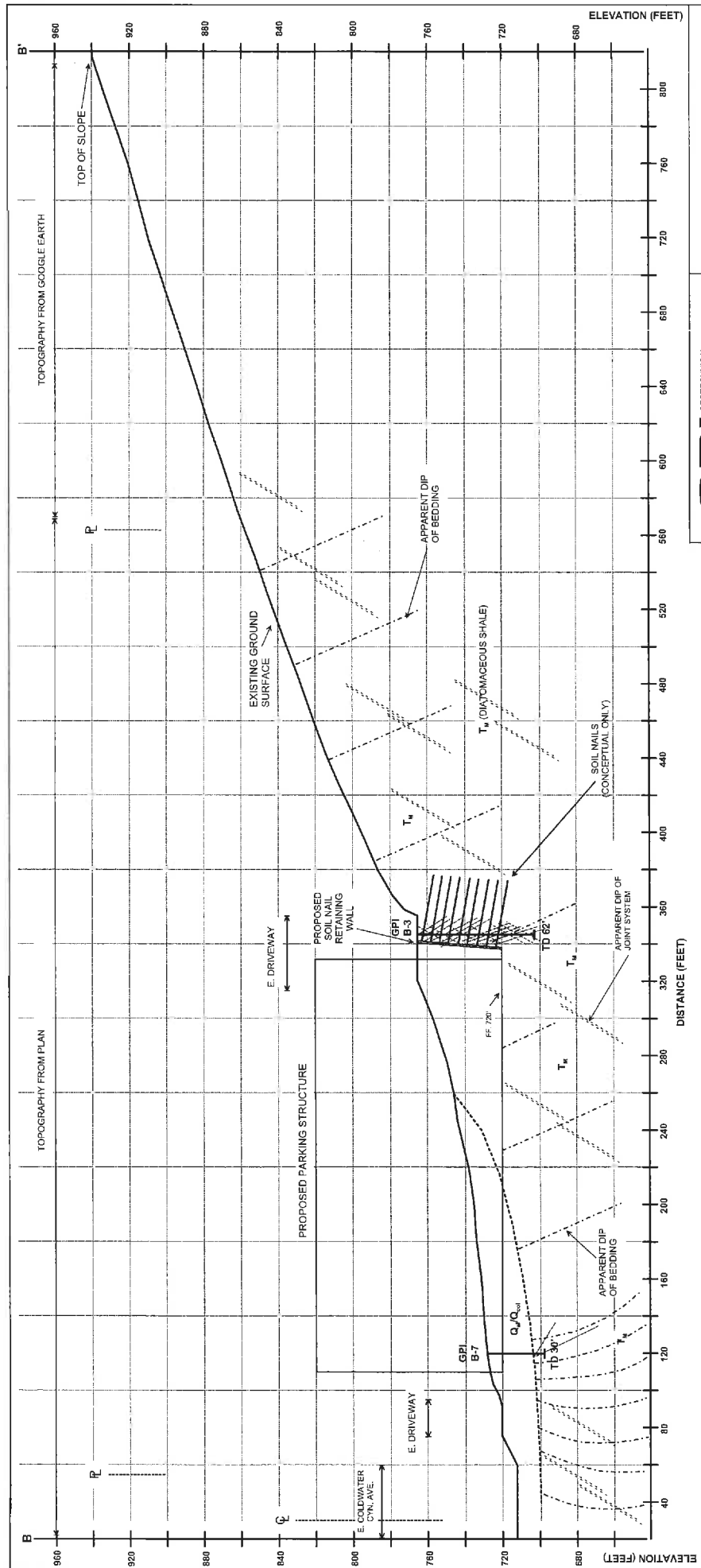

GPI
 GEOTECHNICAL
 PROFESSIONALS, INC.

IDG - HARVARD WESTLAKE
 GPI PROJECT NO.: 2270.1
 SCALE: 1" = 40'

CROSS SECTION B-B'

FIGURE 5

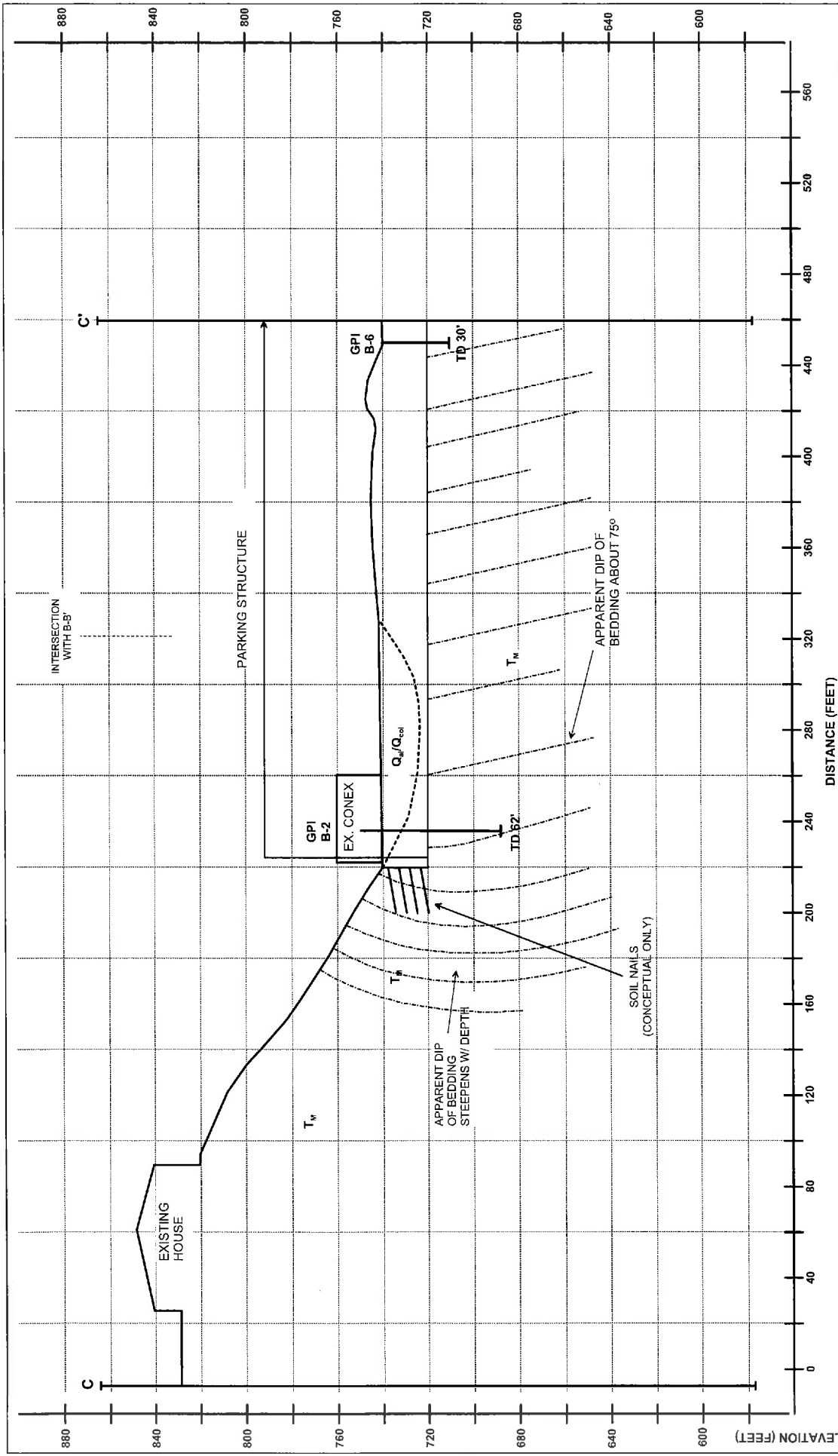

CROSS SECTION C-C'

GPI GEOTECHNICAL PROFESSIONALS, INC.

IDG - HARVARD WESTLAKE

GPI PROJECT NO. 22701 SCALE: 1" = 40'

FIGURE 6

APPENDIX A

APPENDIX A



EXPLORATORY BORINGS

The subsurface conditions at the site were investigated by drilling and sampling ten exploratory borings. The borings were advanced to depths of 21 to 71 feet below the existing ground surface. The location of the exploration is shown on the Site Plan, Figure 2.

The borings were drilled using truck-mounted bucket auger equipment. Relatively undisturbed samples were obtained using a brass-ring lined sampler (ASTM D 3550). The brass-rings have an inside diameter of 2.42 inches. The ring samples were driven into the soil by a 2400-pound hammer dropping 12 inches. At depths from 24 to 43 feet, the ring samples were driven into the soil by a 1550-pound hammer dropping 12 inches. At depths below 43 feet, the ring samples were driven into the soil by an 850-pound hammer dropping 12 inches. The number of blows needed to drive the sampler into the soil was recorded as the penetration resistance. One blow with a 2400-pound Kelly bar (upper 25 feet) typically provides an equivalent penetration of 8 to 10 blows with the drive sampler using the hollow-stem rig.

The field explorations for the investigation were performed under the continuous technical supervision of GPI's representative, who visually inspected the site, maintained detailed logs of the borings, classified the soils encountered, and obtained relatively undisturbed samples for examination and laboratory testing. The soils encountered in the borings were classified in the field and through further examination in the laboratory in accordance with the Unified Soils Classification System. Detailed logs of the borings are presented in Figures A-1 to A-10 in this appendix.

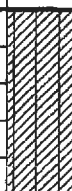
The boring location was laid out in the field by measuring from existing site features. The ground surface elevations at the boring locations were estimated from a preliminary site plan prepared by Innovative Design Group (not dated) and should be considered approximate.

	MOISTURE (%)	DRY DENSITY (PCF)	PENETRATION RESISTANCE (BLOWS/FOOT)	SAMPLE TYPE	DEPTH (FEET)	DESCRIPTION OF SUBSURFACE MATERIALS		ELEVATION (FEET)
						This summary applies only at the location of this boring and at the time of drilling. Subsurface conditions may differ at other locations and may change at this location with the passage of time. The data presented is a simplification of actual conditions encountered.		
					0		Alluvium/Colluvium: SILTY CLAY (CL) dark brown, slightly moist, soft, porous, with 20-30% white, gravel-cobble size shale fragments, with many roots	760
	18.4	61	3	D	5		SANDY SILT (ML) brown, very moist, very stiff @ 6' and 10'-6", thick gravel beds of shale fragments, irregular	755
	19.3	65	3	D	10			
					15		Monterey Formation: SILTSTONE gray to light brown, very moist, hard, highly weathered, fractured, diatomaceous shale No continuous or coherent bedding @ 13 feet, hard, intact diatomaceous shale with continuous bedding. Mod-highly fractured with open fractures 1/8" to 1/4" wide @ 13.5 feet, B: N78E, 71NW @ 15.5 feet, B: N76E, 74NW J: N10E, 44SE Gypsum filled joints at 6"-12" spacing @ 17.5 feet, B: N72E, 74NW J: N10W, 34NE As above, 6"-12" spacing, gypsum filled	750
	25.7	82	9	D	15			745
	37.7	72	11	D	20		Total Depth 21 feet No water or caving Backfilled and tamped with drill cuttings	

SAMPLE TYPES

- Rock Core
- Standard Split Spoon
- Drive Sample
- Bulk Sample
- Tube Sample

DATE DRILLED:

11-18-09

EQUIPMENT USED:

24" Bucket Auger

GROUNDWATER LEVEL (ft):

Not Encountered



PROJECT NO.: 2270.I

HARVARD-WESTLAKE

LOG OF BORING NO. B-1

FIGURE A-1

MOISTURE (%)	DRY DENSITY (PCF)	PENETRATION RESISTANCE (BLOWS/FOOT)	SAMPLE TYPE	DEPTH (FEET)	DESCRIPTION OF SUBSURFACE MATERIALS		ELEVATION (FEET)
					This summary applies only at the location of this boring and at the time of drilling. Subsurface conditions may differ at other locations and may change at this location with the passage of time. The data presented is a simplification of actual conditions encountered.		
				0		Alluvium/Colluvium:	
						SANDY SILT (ML) dark brown, dry to slightly moist, soft, porous, with white diatomaceous shale fragments, roots to 2-3" diameter, massive	745
18.3	63	2	D	5		@ 5 feet, stiff	740
						@ 8 feet, 6"-8" thick, poorly defined gravel bed of shale fragments	
20.4	64	2	D	10			735
29.0	81						
25.0	85						
25.0	85						
19.4	72	3	D	15		@ 14 feet, poorly defined gravel bed of shale fragments	
						SILT (MH) brown, wet, very stiff	730
22.8	63	3	D	20			725
						Monterey Formation:	
32.7	77	10	D	25		SILTSTONE gray to light brown, very moist, hard, high weathered with soil pockets, no continuous bedding	720
						@ 25 feet, highly fractured but hard shale with gypsum filled fractures	
						B: N74E, 81SE	
41.4	69	6/6"	D	35		@ 33 feet, B: N71E, 78NW, shale continues highly fractured with filled and partially filled gypsum seams	715
						@ 38 feet, B: N72E, 78NW, shale is very hard with gypsum filled fractures	710

SAMPLE TYPES

- C Rock Core
- S Standard Split Spoon
- D Drive Sample
- B Bulk Sample
- T Tube Sample

DATE DRILLED:
11-18-09

EQUIPMENT USED:
24" Bucket Auger

GROUNDWATER LEVEL (ft):
Not Encountered



PROJECT NO.: 2270.1
HARVARD-WESTLAKE

LOG OF BORING NO. B-2

FIGURE A-2

	MOISTURE (%)	DRY DENSITY (PCF)	PENETRATION RESISTANCE (BLOWS/FOOT)	SAMPLE TYPE	DEPTH (FEET)	DESCRIPTION OF SUBSURFACE MATERIALS		ELEVATION (FEET)
						This summary applies only at the location of this boring and at the time of drilling. Subsurface conditions may differ at other locations and may change at this location with the passage of time. The data presented is a simplification of actual conditions encountered.		
	42.0	70	30/9"	D	40		@ 40 feet, all joints tight, filled with gypsum, shale is very hard	705
					45		@ 45 to 46 feet, start of unoxidized shale in irregular patches @ 46 feet, B: N74E, 76NW	700
			50/5"	D	50		@ 49 feet, B71E, 72NW @ 50 feet, dark grey, unoxidized shale, very hard, few gypsum filled fractures @ 52 feet, unfractured, no gypsum	695
					55		@ 54 feet, B: N71E, 84NW @ 56 feet, B: N80E, 78NW	690
	32.9	75	50/5"	D	60			685
						Total Depth 62.5 feet No water or caving Backfilled with cuttings and tamped		

SAMPLE TYPES

- C Rock Core
- S Standard Split Spoon
- D Drive Sample
- B Bulk Sample
- T Tube Sample

DATE DRILLED:
11-18-09

EQUIPMENT USED:
24" Bucket Auger

GROUNDWATER LEVEL (ft):
Not Encountered



PROJECT NO.: 2270.1
HARVARD-WESTLAKE

LOG OF BORING NO. B-2

	MOISTURE (%)	DRY DENSITY (PCF)	PENETRATION RESISTANCE (BLOWS/FOOT)	SAMPLE TYPE	DEPTH (FEET)	DESCRIPTION OF SUBSURFACE MATERIALS		ELEVATION (FEET)
						This summary applies only at the location of this boring and at the time of drilling. Subsurface conditions may differ at other locations and may change at this location with the passage of time. The data presented is a simplification of actual conditions encountered.		
					0	Fill:		
						SILT (ML) yellow brown and white, diatomaceous silt, with shale debris		
						Monterey Formation:		760
	46.2	64	8	D	5	SILTSTONE gray to light brown, very moist, hard, moderately fractured, diatomaceous shale @ 1.5 feet, B: N85E, 68NW @ 6 feet, B: N74E, 63NW, hard, slightly fractured		755
	33.6	82	5	D	10	@ 10 feet, joint set @ 12" spacing J: NS, 75E B: N72E, 68NW		750
	34.0	84	7	D	15	@ 16 feet, B: N62E, 67NW J: N5W, 67NE		745
	28.4	87	4	D	20	@ 21 feet, B: N71E, 68NW very hard, few joints, very tight		740
	37.7	73	14	D	25	@ 25 feet, B: N72E, 67NW		735
	84.0	49	20	D	30	@ 28 feet, J: N8E, 68SE (tight)		730
	44.4	71	11	D	35	@ 33 feet, B: N70E, 73NW @ 36 feet, J: N8W, 58NE B: N70E, 71NW		725

SAMPLE TYPES

- C Rock Core
- S Standard Split Spoon
- D Drive Sample
- B Bulk Sample
- T Tube Sample

DATE DRILLED:

11-17-09

EQUIPMENT USED:

24" Bucket Auger

GROUNDWATER LEVEL (ft):

Not Encountered





PROJECT NO.: 2270.1

HARVARD-WESTLAKE

LOG OF BORING NO. B-3

FIGURE A-3

	MOISTURE (%)	DRY DENSITY (PCF)	PENETRATION RESISTANCE (BLOWS/FOOT)	SAMPLE TYPE	DEPTH (FEET)	DESCRIPTION OF SUBSURFACE MATERIALS		ELEVATION (FEET)	
						This summary applies only at the location of this boring and at the time of drilling. Subsurface conditions may differ at other locations and may change at this location with the passage of time. The data presented is a simplification of actual conditions encountered.			
	44.7	75	13	D	40		@ 43 feet, B: N75E, 74NW	720	
	33.4	83	30/9"	D	45		@ 46 feet, J: N18E, 70SE	715	
	51.6	70	35	D	50		@ 50 feet, B: N72E, 74NW J: N12W, 63NE	710	
	43.6	72	50/11"	D	55		@ 56 feet, J: N8W, 58NE B: N71E, 74NW @ 57.5 feet, B: N73E, 75NW J: N7W, 60NE	705	
	50.3	69	50/10"	D	60				
	52.7	64	50/7"	D					
						Total Depth 63 feet No water or caving Backfilled with cuttings and tamped		700	
SAMPLE TYPES <input type="checkbox"/> Rock Core <input checked="" type="checkbox"/> Standard Split Spoon <input type="checkbox"/> Drive Sample <input type="checkbox"/> Bulk Sample <input type="checkbox"/> Tube Sample		DATE DRILLED: 11-17-09 EQUIPMENT USED: 24" Bucket Auger GROUNDWATER LEVEL (ft): Not Encountered				PROJECT NO.: 2270.I HARVARD-WESTLAKE		LOG OF BORING NO. B-3 FIGURE A-3	

MOISTURE (%)	DRY DENSITY (PCF)	PENETRATION RESISTANCE (BLOWS/FOOT)	SAMPLE TYPE	DEPTH (FEET)	DESCRIPTION OF SUBSURFACE MATERIALS		ELEVATION (FEET)
					This summary applies only at the location of this boring and at the time of drilling. Subsurface conditions may differ at other locations and may change at this location with the passage of time. The data presented is a simplification of actual conditions encountered.		
				0	Fill:		
					SILT (ML) brown, dry, soft, gravelly		
					Colluvium:		
					SILT (ML) dark brown, moist, firm, with white diatomaceous shale fragments		755
					Monterey Formation:		
				5	SILTSTONE grey to light brown, moist, hard, carbonate bed, blocky fracturing, loose		
					@ 2.5 feet, B: N60E, 60NW		
					@ 3 to 11 feet, moderately-highly fractured/weathered, diatomaceous shale		750
				10	@ 8 feet, B: N61E, 69NW		
					@ 10 feet, very moist		
					@ 12 feet, diatomaceous shale, very tight, very few fractures/joints		745
					B: N68E, 71NW		
				15			
					@ 17 feet, B: N70E, 64NW		740
				20			
					@ 23 feet, B: N68E, 60NW		735
				25			
					@ 26 feet, J: N10E, 47SE		730
				30			
					@ 32 feet, B: N68E, 66NW		725
				35			
					@ 37 feet, B: N66E, 65NW		720

SAMPLE TYPES

- C Rock Core
- S Standard Split Spoon
- D Drive Sample
- B Bulk Sample
- T Tube Sample

DATE DRILLED:

11-16-09

EQUIPMENT USED:

24" Bucket Auger

GROUNDWATER LEVEL (ft):

Not Encountered



PROJECT NO.: 2270.1
HARVARD-WESTLAKE

LOG OF BORING NO. B-4

FIGURE A-4

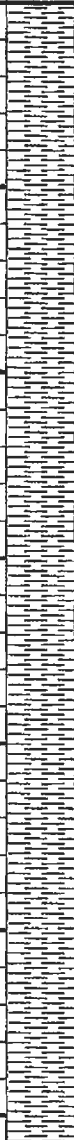
	MOISTURE (%)	DRY DENSITY (PCF)	PENETRATION RESISTANCE (BLOWS/FOOT)	SAMPLE TYPE	DEPTH (FEET)	DESCRIPTION OF SUBSURFACE MATERIALS		ELEVATION (FEET)
						This summary applies only at the location of this boring and at the time of drilling. Subsurface conditions may differ at other locations and may change at this location with the passage of time. The data presented is a simplification of actual conditions encountered.		
	109.6	38	10/6"	D	40	 <p>@ 42 feet, B: N67E, 65NW J: N11W, 61NE (tight)</p> <p>@ 48 feet, B: N70E, 68NW change to dark grey, unoxidized shale @ 49 feet, B: N70E, 68NW</p> <p>@ 56 feet, B: N68E, 66NW</p> <p>@ 61 feet, B: N68E, 61NW</p> <p>@ 66 feet, B: N65E, 58NW J: N9W, 47NE (tight)</p>	715	
	104.3	40	26/6"	D	45		710	
	43.0	74	25/6"	D	50		705	
	31.1	83	50/6"	D	55		700	
	37.3	72	50/7"	D	60		695	
	63.0	57	20/7"	D	65		690	
	83.7	48	20/7"	D	70			
							Total Depth 71 feet No water or caving Backfilled with cuttings and tamped	

SAMPLE TYPES

- Rock Core
- Standard Split Spoon
- Drive Sample
- Bulk Sample
- Tube Sample

DATE DRILLED:
11-16-09

EQUIPMENT USED:
24" Bucket Auger

GROUNDWATER LEVEL (ft):
Not Encountered



PROJECT NO.: 2270.I
HARVARD-WESTLAKE

LOG OF BORING NO. B-4

FIGURE A-4

MOISTURE (%)	DRY DENSITY (PCF)	PENETRATION RESISTANCE (BLOWS/FOOT)	SAMPLE TYPE	DEPTH (FEET)	DESCRIPTION OF SUBSURFACE MATERIALS		ELEVATION (FEET)
					This summary applies only at the location of this boring and at the time of drilling. Subsurface conditions may differ at other locations and may change at this location with the passage of time. The data presented is a simplification of actual conditions encountered.		
				0		Fill: SILT (ML) brown, dry, soft, horizontal contact with soil, with 3/4" crushed gravel	760
16.1	74	4	D	5		Residual Soil/Colluvium: CLAYEY SILT (ML)/SILTY CLAY (CL) dark brown, moist, firm, porous, with 10%-20% shale fragments, with roots to 1/2" diameter	755
58.4	49	12	D	10		Monterey Formation: SILTSTONE whitish and yellow brown, very moist, hard, diatomaceous shale, very few fractures @ 8.5 feet, B: N72E, 65NW @ 10 feet, J: N10W, 75NE @ 12 feet, B: N71E, 4NW J: N5W, 48NE	750
46.4	58	7/8"	D	15		@ 15 feet, B: N64E, 61NW @ 15.5 feet, J: N12W, 60NE partially open to 1/4" with roots	745
60.5	56	10/10"	D	20		@ 21 feet, B: N64E, 65NW	740
45.3	72	13	D	25		@ 25 feet, B: N68E, 63NW J: N65E, 62SE (tight)	735
50.9	67	12	D	30		@ 30 feet, B: N68E, 64NW	730
84.0	48	15	D	35		@ 35 feet, B: N70E, 65NW	725
						@ 38 feet, J: N8W, 51NE	

SAMPLE TYPES

- C Rock Core
- S Standard Split Spoon
- D Drive Sample
- B Bulk Sample
- T Tube Sample

DATE DRILLED:

11-17-09

EQUIPMENT USED:

24" Bucket Auger

GROUNDWATER LEVEL (ft):

Not Encountered



PROJECT NO.: 2270.1
HARVARD-WESTLAKE

LOG OF BORING NO. B-5

FIGURE A-5

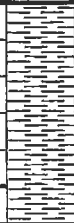
	MOISTURE (%)	DRY DENSITY (PCF)	PENETRATION RESISTANCE (BLOWS/FOOT)	SAMPLE TYPE	DEPTH (FEET)	DESCRIPTION OF SUBSURFACE MATERIALS		ELEVATION (FEET)
						This summary applies only at the location of this boring and at the time of drilling. Subsurface conditions may differ at other locations and may change at this location with the passage of time. The data presented is a simplification of actual conditions encountered.		
	74.5	54	11	D	40		@ 40 feet, B: N69E, 59NW	720
	83.6	47	30/6"	D	45			
						Total Depth 46 feet No water or caving Backfilled		

SAMPLE TYPES

- C Rock Core
- S Standard Split Spoon
- D Drive Sample
- B Bulk Sample
- T Tube Sample

DATE DRILLED:
11-17-09

EQUIPMENT USED:
24" Bucket Auger

GROUNDWATER LEVEL (ft):
Not Encountered



PROJECT NO.: 2270.1
HARVARD-WESTLAKE

LOG OF BORING NO. B-5

FIGURE A-5

	MOISTURE (%)	DRY DENSITY (PCF)	PENETRATION RESISTANCE (BLOWS/FOOT)	SAMPLE TYPE	DEPTH (FEET)	DESCRIPTION OF SUBSURFACE MATERIALS		ELEVATION (FEET)
						This summary applies only at the location of this boring and at the time of drilling. Subsurface conditions may differ at other locations and may change at this location with the passage of time. The data presented is a simplification of actual conditions encountered.		
					0		Monterey Formation: SILTSTONE grey and yellowish white, moist to very moist, hard, diatomaceous shale, laminated to thin bedded, few fractures @ 0.5 feet, B: N71E, 74NW	740
	29.0	75	4	D	5		@ 5 feet, B: N68E, 73NW	735
	38.3	76	9	D	10		@ 8 feet, B: N69E, 68NW @ 10 feet, B: N69E, 68NW	730
					15		@ 14 feet, B: N71E, 72NW	725
	90.7	45	8/7"	D	20		@ 17 feet, B: N70E, 73NW @ 22 feet, B: N71E, 72NW	720
					25		@ 25 feet, B: N71E, 77NW	715
	76.2	47	9	D	30			710
						Total Depth 31 feet No water or caving Backfilled with cuttings and tamped		

SAMPLE TYPES

- C Rock Core
- S Standard Split Spoon
- D Drive Sample
- B Bulk Sample
- T Tube Sample

DATE DRILLED:
11-18-09

EQUIPMENT USED:
24" Bucket Auger

GROUNDWATER LEVEL (ft):
Not Encountered



PROJECT NO.: 2270.1
HARVARD-WESTLAKE

LOG OF BORING NO. B-6

FIGURE A-6

	MOISTURE (%)	DRY DENSITY (PCF)	PENETRATION RESISTANCE (BLOWS/FOOT)	SAMPLE TYPE	DEPTH (FEET)	DESCRIPTION OF SUBSURFACE MATERIALS		ELEVATION (FEET)
						This summary applies only at the location of this boring and at the time of drilling. Subsurface conditions may differ at other locations and may change at this location with the passage of time. The data presented is a simplification of actual conditions encountered.		
					0	AC Pavement		720
	18.5	55	2	D	5	Fill: CLAYEY SILT (ML) brown, slightly moist, firm, white shale fragments Alluvium/Colluvium: CLAYEY SILT (ML) brown, moist, with sand to gravel size white shale fragments, soft, very porous to about 10 feet then less, roots to 1" diameter	715	
	20.3	54	3	D	10		710	
	27.0	73	5	D	15		705	
	43.9	69	3	D	20	Monterey Formation: SILTSTONE grey to light brown, very moist, very stiff, highly weathered and fractured shale, no continuous bedding @ 23 feet, grey to light brown, diatomaceous shale, hard B: N80E, 45NW	700	
	48.4	71	8	D	25	@ 25 feet, B: N85E, 44NW	695	
	50.0	68	6	D	30	@ 27.5 feet, B: N75E, 72NW hard, coherent shale	690	
						Total Depth 31 feet No water or caving		

SAMPLE TYPES

- C Rock Core
- S Standard Split Spoon
- D Drive Sample
- B Bulk Sample
- T Tube Sample

DATE DRILLED:

11-19-09

EQUIPMENT USED:

24" Bucket Auger

GROUNDWATER LEVEL (ft):





Not Encountered



PROJECT NO.: 2270.1
HARVARD-WESTLAKE

LOG OF BORING NO. B-7

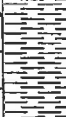
FIGURE A-7

	MOISTURE (%)	DRY DENSITY (PCF)	PENETRATION RESISTANCE (BLOWS/FOOT)	SAMPLE TYPE	DEPTH (FEET)	DESCRIPTION OF SUBSURFACE MATERIALS		ELEVATION (FEET)
						This summary applies only at the location of this boring and at the time of drilling. Subsurface conditions may differ at other locations and may change at this location with the passage of time. The data presented is a simplification of actual conditions encountered.		
					0		Fill: CLAYEY SILT (ML) yellow brown, dry, soft, with diatomaceous, shale fragments, roots to 1" diameter, horizontal lower contact	720
	90.7	43	6/7"	D	5		Monterey Formation: BEDROCK white-yellow brown, very moist, hard, diatomaceous shale, thin bedded, few tight fractures/joints @ 3 feet, B: N53E, 73NW @ 8 feet, B: N58E, 69NW	715
	67.1	59	7/10"	D	10		@ 11 feet, B: N61E, 63NW J: N5, 51E	710
					15		@ 15 feet, B: N63E, 67NW	705
	16.1	108	8/7"	D	20			700
						Total Depth 21 feet No water or caving Backfilled with cuttings		

SAMPLE TYPES

- C Rock Core
- S Standard Split Spoon
- D Drive Sample
- B Bulk Sample
- T Tube Sample

DATE DRILLED:

11-18-09

EQUIPMENT USED:

24" Bucket Auger

GROUNDWATER LEVEL (ft):

Not Encountered



PROJECT NO.: 2270.1

HARVARD-WESTLAKE

LOG OF BORING NO. B-8

FIGURE A-8

MOISTURE (%)	DRY DENSITY (PCF)	PENETRATION RESISTANCE (BLOWS/FOOT)	SAMPLE TYPE	DEPTH (FEET)	DESCRIPTION OF SUBSURFACE MATERIALS	ELEVATION (FEET)
					This summary applies only at the location of this boring and at the time of drilling. Subsurface conditions may differ at other locations and may change at this location with the passage of time. The data presented is a simplification of actual conditions encountered.	
				0	AC Pavement	715
					Fill: SILTY CLAY (CL) dark brown, very moist, firm, with whitish shale fragments, sloping contact with bx below dips to N (parallel to hillside)	
				5	Monterey Formation: SILTSTONE yellow brown, shaly siltstone, moist, hard, moderately-highly fractured to 8-9 feet then hard, little fractured	710
				10	@ 4.5 feet, N: N85E, 65SE @ 7.5 feet, B: N87E, 66SE less fractured	705
				15	@ 9 feet, discontinuous shear, paper thin S: N33W, 31NE @ 10 feet, B: N86E, 78SE Hard, few fractures @ 13 feet, B: N81W, 79SW very hard, shaly siltstone @ 15 feet, B: EW, 79S hard, diatomaceous shale, very few irregular fractures	700
				20	@ 19 feet, B: EW, 84S J: N10W, 88SW	695
				25	@ 22 feet, Darker in color, medium brown, very hard B: EW, 89S J: N10W, 60NE @ 22.5 feet, start of dark grey, unoxidized siltstone in irregular patches @ 25.5 feet, B: N88E, 84SE J: N7W, 78NE @ 26 to 30 feet, very hard, dark grey, unoxidized shaly siltstone	690
				30	Total Depth 30 feet No samples collected Backfilled with cuttings	685

SAMPLE TYPES

- C Rock Core
- S Standard Split Spoon
- D Drive Sample
- B Bulk Sample
- T Tube Sample

DATE DRILLED:

12-16-09

EQUIPMENT USED:

24" Bucket Auger

GROUNDWATER LEVEL (ft):

Not Encountered



PROJECT NO.: 2270.1
HARVARD-WESTLAKE

LOG OF BORING NO. B-9

FIGURE A-9

MOISTURE (%)	DRY DENSITY (PCF)	PENETRATION RESISTANCE (BLOWS/FOOT)	SAMPLE TYPE	DEPTH (FEET)	DESCRIPTION OF SUBSURFACE MATERIALS	ELEVATION (FEET)
					<p>This summary applies only at the location of this boring and at the time of drilling. Subsurface conditions may differ at other locations and may change at this location with the passage of time. The data presented is a simplification of actual conditions encountered.</p>	
				0	<p>Natural: Residual soil CLAYEY SILT (ML) dark brown, with shale rock fragments, very moist, soft, porous with roots</p>	740
				5	<p>Monterey Formation: SILTSTONE white chalky diatomaceous shale, laminated/thin bedded, moderately fractured with roots along fractures, hard</p>	735
				10	<p>@ 2 feet, B: N71E, 55SE @ 6 feet, as above, light yellowish brown, shaly siltstone, diatomaceous in part B: N79E, 57SE J: N70W, 56NE</p>	730
				15	<p>@ 9.5 feet, B: N85E, 57SE hard shale, very tight, few fractures</p> <p>@ 13 feet, polished, paper thin clay, parallel bedding, grooves, parallel dip S/B: N89E, 57SE</p>	725
				20	<p>@ 19 feet, B: N84E, 63SE hard diatomaceous shale, little fractures J: N80W, 45NE</p>	720
				25	<p>@ 22 feet, B: N83E, 68SE</p> <p>@ 24.5 feet, 1/2" wide shear zone, disrupts bedding S/F: N15W, 78NE @ 26 feet, B: N87W, 78SW</p>	715
				30	<p>@ 30 feet, hard grey shale, unfractured B: 84E, 82SE</p> <p>@ 32 feet, B: EW, 83S, hard (tight) @ 32 to 35 feet, patches of dark grey, unoxidized shale</p>	710
				35	<p>Total Depth 35 feet No water or caving Backfilled; No samples collected</p>	705

- SAMPLE TYPES**
- C Rock Core
 - S Standard Split Spoon
 - D Drive Sample
 - B Bulk Sample
 - T Tube Sample

DATE DRILLED:
12-16-09

EQUIPMENT USED:
24" Bucket Auger

GROUNDWATER LEVEL (ft):
Not Encountered



PROJECT NO.: 2270.1
HARVARD-WESTLAKE

LOG OF BORING NO. B-10

FIGURE A-10

APPENDIX B

APPENDIX B

LABORATORY TESTS

INTRODUCTION

Representative undisturbed soil samples and bulk samples were carefully packaged in the field and sealed to prevent moisture loss. The samples were then transported to our Cypress office for examination and testing assignments. Laboratory tests were performed on selected representative samples as an aid in classifying the soils and to evaluate the physical properties of the soils affecting foundation design and construction procedures. Detailed descriptions of the laboratory tests are presented below under the appropriate test headings. Test results are presented in the figures that follow.

MOISTURE CONTENT AND DRY DENSITY

Moisture content and dry density were determined from a number of the ring samples. The samples were first trimmed to obtain volume and wet weight and then were dried in accordance with ASTM D 2216. After drying, the weight of each sample was measured, and moisture content and dry density were calculated. Moisture content and dry density values are presented on the boring logs in Appendix A.

ATTERBERG LIMITS

Liquid and plastic limits were determined for a selected sample in accordance with ASTM D4318. Results of the Atterberg Limits test are summarized on Figure B-1.

DIRECT SHEAR

Direct shear tests were performed on undisturbed and remolded bulk samples in accordance with ASTM D 3080. The bulk sample was remolded to approximately 90 percent of the maximum dry density (ASTM D 1557). The samples were placed in the shear machine, and a normal load comparable to the in-situ overburden stress was applied. The samples were inundated, allowed to consolidate, and then were sheared to failure. The tests were repeated on additional test specimens under increased normal loads. Shear stress and sample deformation were monitored throughout the test. The results of the direct shear tests are presented in Figures B-2 to B-4.

A direct shear test was performed on ring samples to determine the residual strength of the soils after repeated deformation of the soil. The samples were sheared up to a deformation at which the shear resistance reached a well defined residual value. The procedure was repeated on additional test specimens from the same soil layer under increased normal loads. The results of the direct shear test to determine the residual value are presented in Figures B-5 to B-9.

CONSOLIDATION

A one-dimensional consolidation test was performed on an undisturbed sample in accordance with ASTM D 2435. After trimming the ends, the sample was placed in the consolidometer and loaded to up to 0.4 ksf. Thereafter, the sample was incrementally loaded to a maximum load of up to 25.6 ksf. The sample was inundated at 1.6 ksf. Sample deformation was measured to 0.0001 inch. Rebound behavior was investigated by unloading the sample back to 0.4 ksf. Results of the consolidation test, in the form of percent consolidation versus log pressure are presented in Figures B-10 and B-11.

EXPANSION INDEX

Expansion index tests were performed on bulk samples and composite ring samples. The tests were performed in accordance with ASTM 4289 to assess the expansion potential of on-site soils. The results of the test are summarized below:

BORING NO.	DEPTH (ft)	SOIL DESCRIPTION	EXPANSION INDEX
B-2	5/10/15	Silt (MH)	41
B-2	10-15	Silt (MH)	42
B-3	20-30	Silt (MH)	27

COMPACTION TEST

Maximum dry density/optimum moisture tests were performed in accordance with ASTM D 1557 on representative bulk samples of the surficial soils. The test result is as follows:

BORING NO.	DEPTH (ft)	SOIL DESCRIPTION	MAXIMUM DRY DENSITY (pcf)	OPTIMUM MOISTURE (%)
B-2	10-15	Silt (MH)	79	40.0
B-3	20-30	Sandy Silt (ML)	99	25.0

CORROSIVITY

Soil corrosivity testing was performed by Schiff Associates on soil samples provided by GPI. The test results are summarized in Table 1 of this appendix.

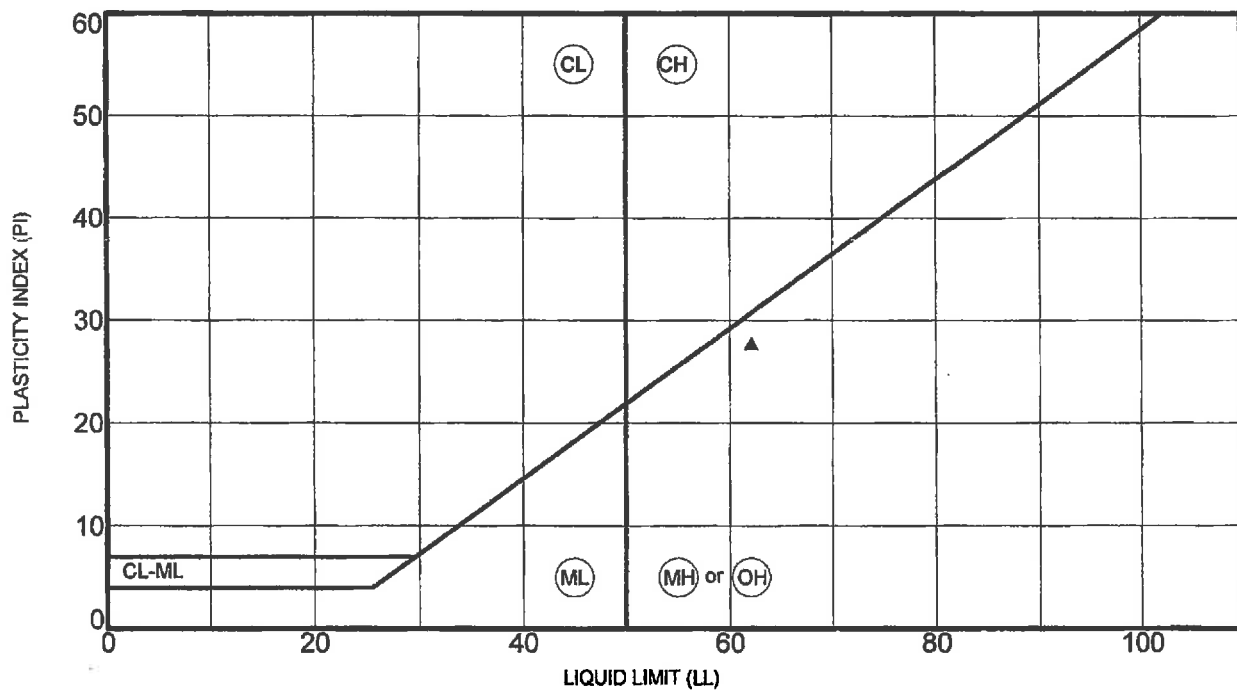

	SAMPLE LOCATION	LL	PL	PI	Fines, %	Classification
▲	B-2	15.0	62	34	28	SILT (MH)

PROJECT: HARVARD-WESTLAKE PROJECT NO. 2270.1



ATTERBERG LIMITS TEST RESULTS

FIGURE B-1

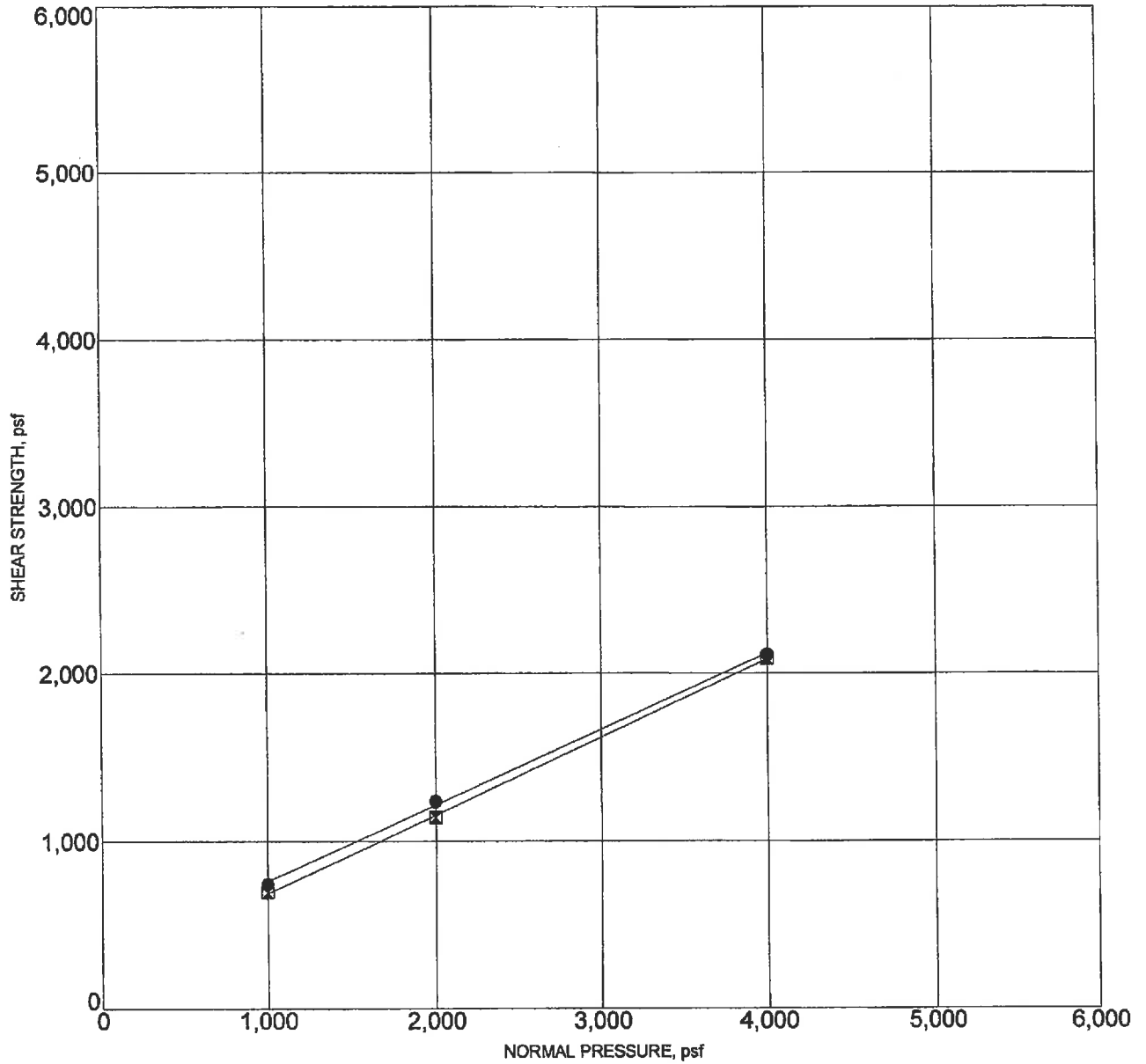

● **PEAK STRENGTH**
Friction Angle= 24 degrees
Cohesion= 306 psf

⊠ **ULTIMATE STRENGTH**
Friction Angle= 25 degrees
Cohesion= 222 psf

Note: Samples remolded to 90% of maximum dry density

Sample Location	Classification	DD,pcf	MC,%
B-2 10-15	SANDY SILT (MH)	81	29.0

PROJECT: HARVARD-WESTLAKE

PROJECT NO.: 2270.1



DIRECT SHEAR TEST RESULTS

FIGURE B-2

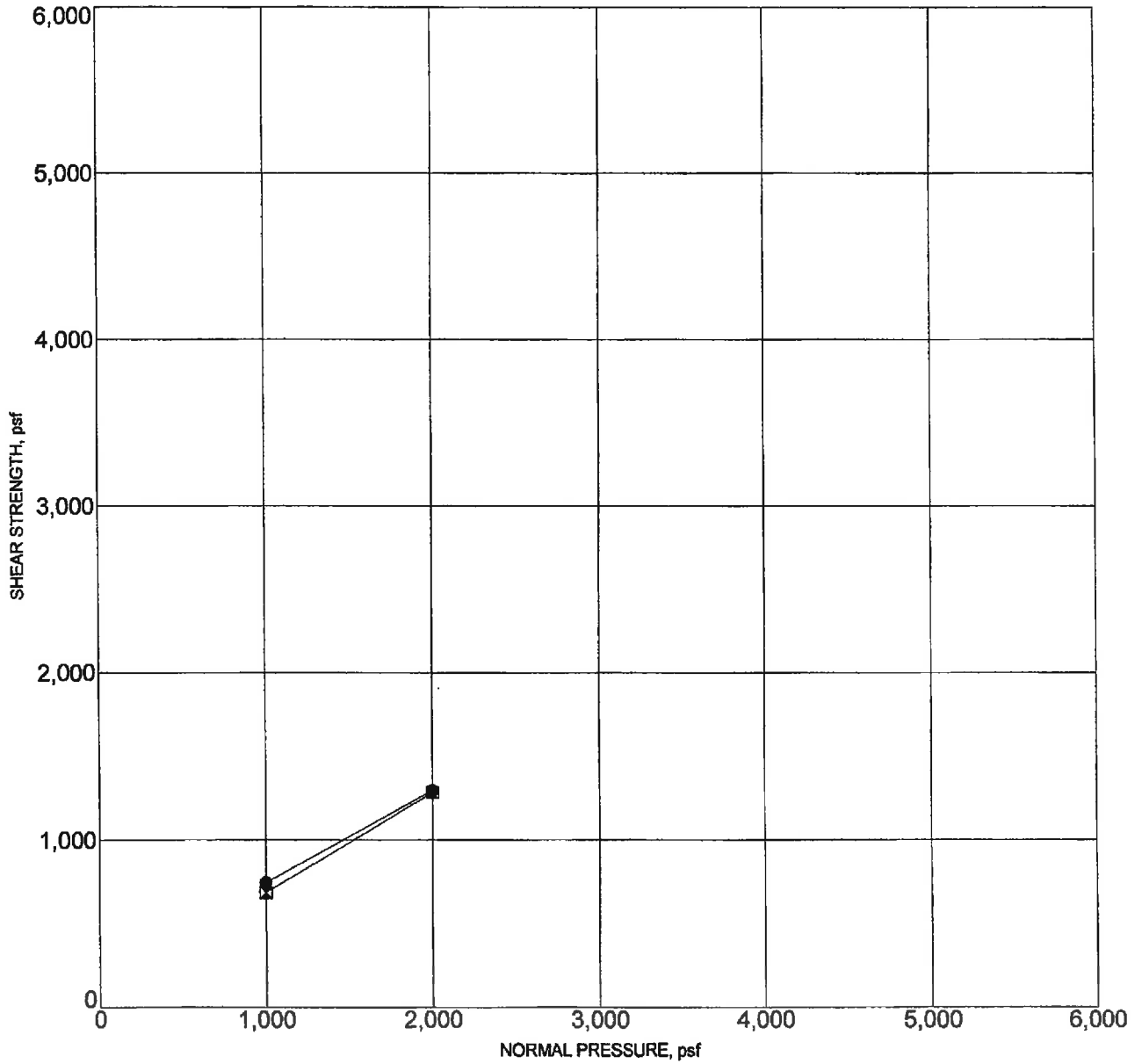

● **PEAK STRENGTH**
Friction Angle= 29 degrees
Cohesion= 192 psf

☒ **ULTIMATE STRENGTH**
Friction Angle= 31 degrees
Cohesion= 84 psf

Sample Location	Classification	DD,pcf	MC,%
B-2 15.0	SILT (MH)	72	19.4

PROJECT: HARVARD-WESTLAKE

PROJECT NO.: 2270.1



DIRECT SHEAR TEST RESULTS

FIGURE B-3

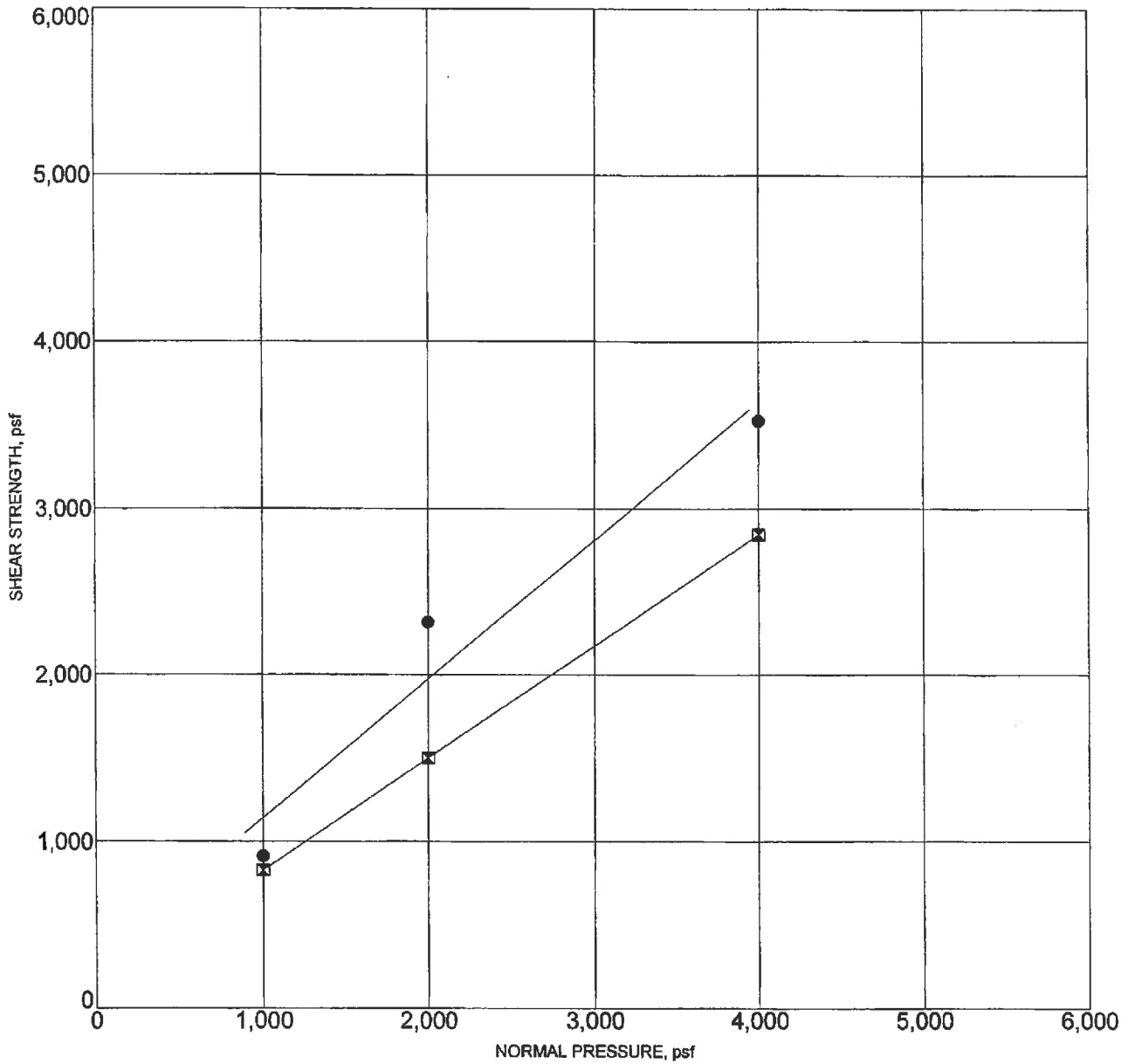

● PEAK STRENGTH
 Friction Angle= 40 degrees
 Cohesion= 306 psf

☐ ULTIMATE STRENGTH
 Friction Angle= 34 degrees
 Cohesion= 156 psf

Note: Samples remolded to 90% of maximum dry density

Sample Location	Classification	DD,pcf	MC,%
B-3 20-30	SILTSTONE	71	40.5

PROJECT: HARVARD-WESTLAKE

PROJECT NO.: 2270.1



DIRECT SHEAR TEST RESULTS

FIGURE B-4

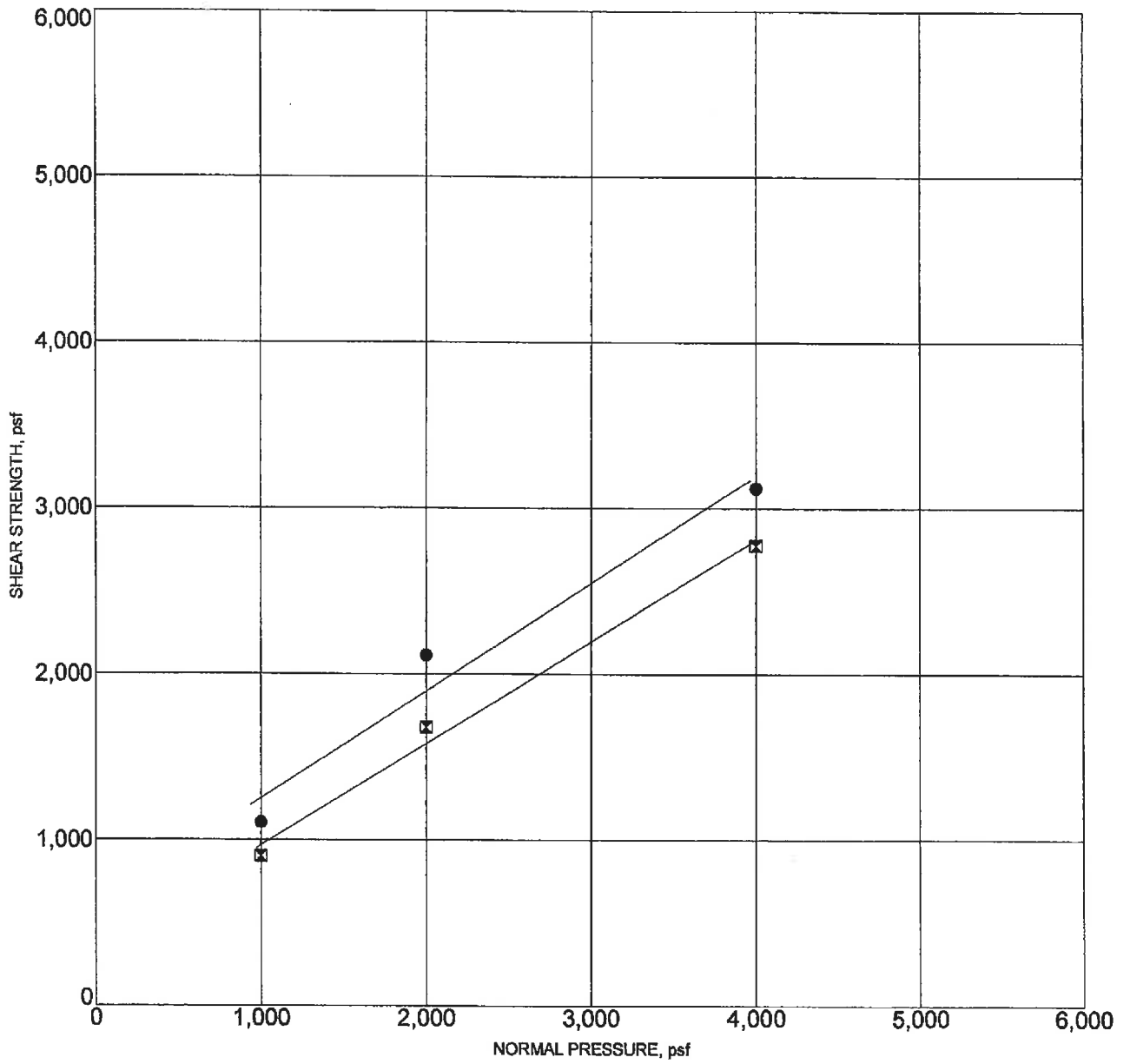

● **PEAK STRENGTH**
Friction Angle= 33 degrees
Cohesion= 600 psf

☒ **ULTIMATE STRENGTH**
Friction Angle= 32 degrees
Cohesion= 354 psf

Sample Location	Classification	DD,pcf	MC,%
B-3 35.0	SILTSTONE	71	44.4

PROJECT: HARVARD-WESTLAKE

PROJECT NO.: 2270.1



DIRECT SHEAR TEST RESULTS

FIGURE B-5

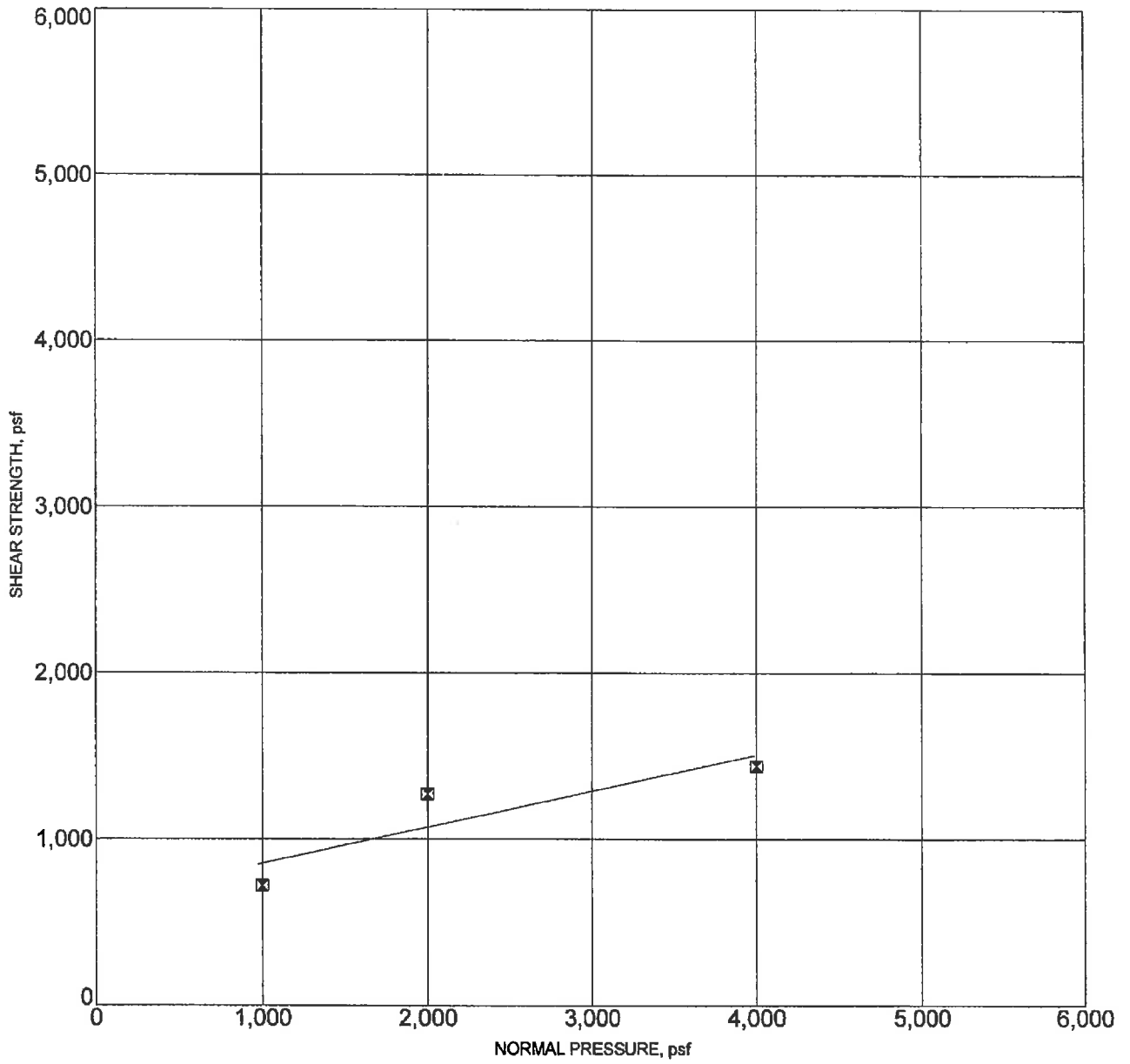

RESIDUAL STRENGTH
 Friction Angle= 12 degrees
 Cohesion= 636 psf

Sample Location	Classification	DD,pcf	MC,%
B-2 25.0	SILTSTONE	77	32.7

PROJECT: HARVARD-WESTLAKE

PROJECT NO.: 2270.1



DIRECT SHEAR TEST RESULTS

FIGURE B-6

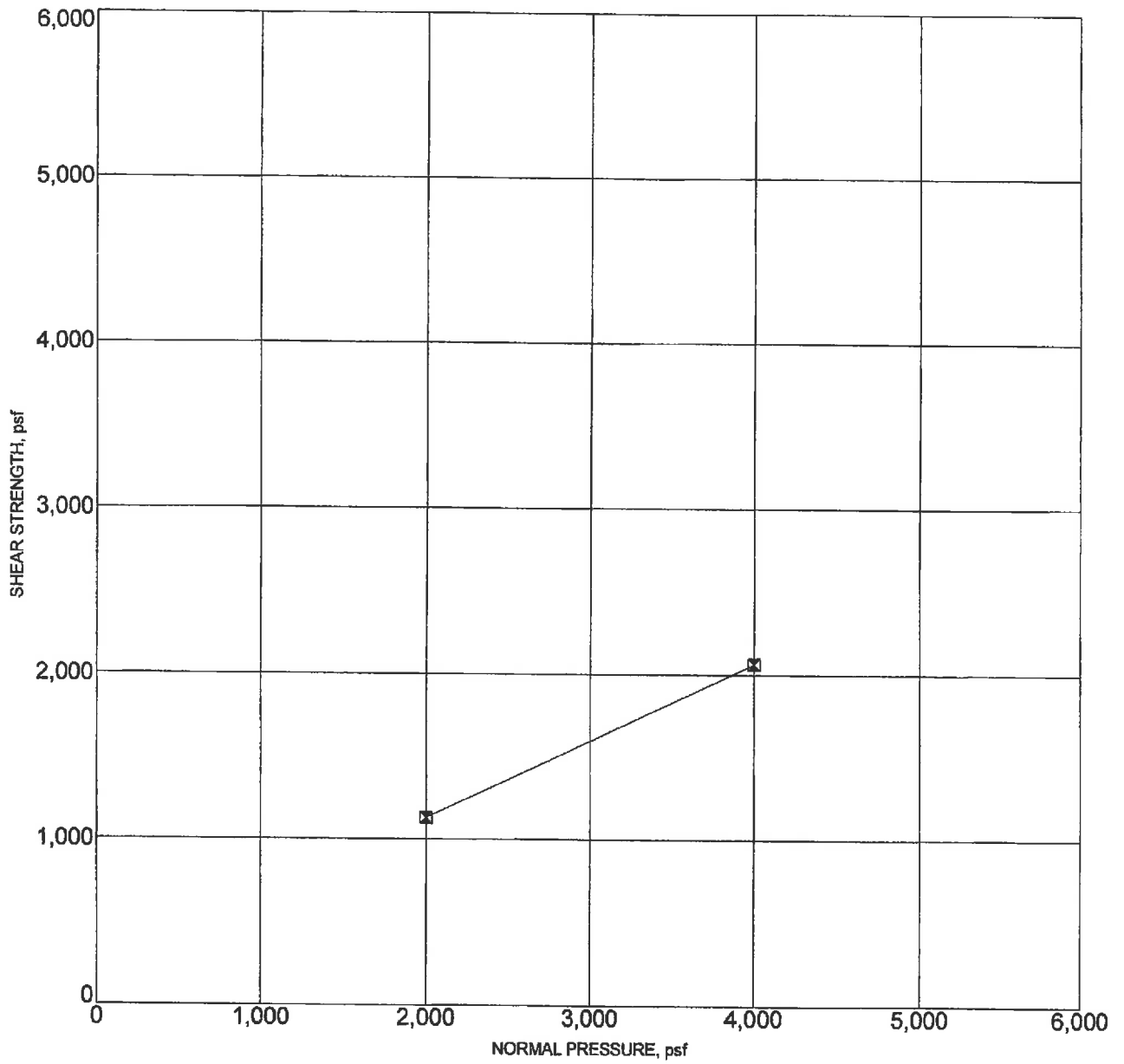

RESIDUAL STRENGTH
 Friction Angle= 25 degrees
 Cohesion= 192 psf

Sample Location	Classification	DD,pcf	MC,%
B-3 20.0	SILTSTONE	87	28.4

PROJECT: HARVARD-WESTLAKE

PROJECT NO.: 2270.1



DIRECT SHEAR TEST RESULTS

FIGURE B-7

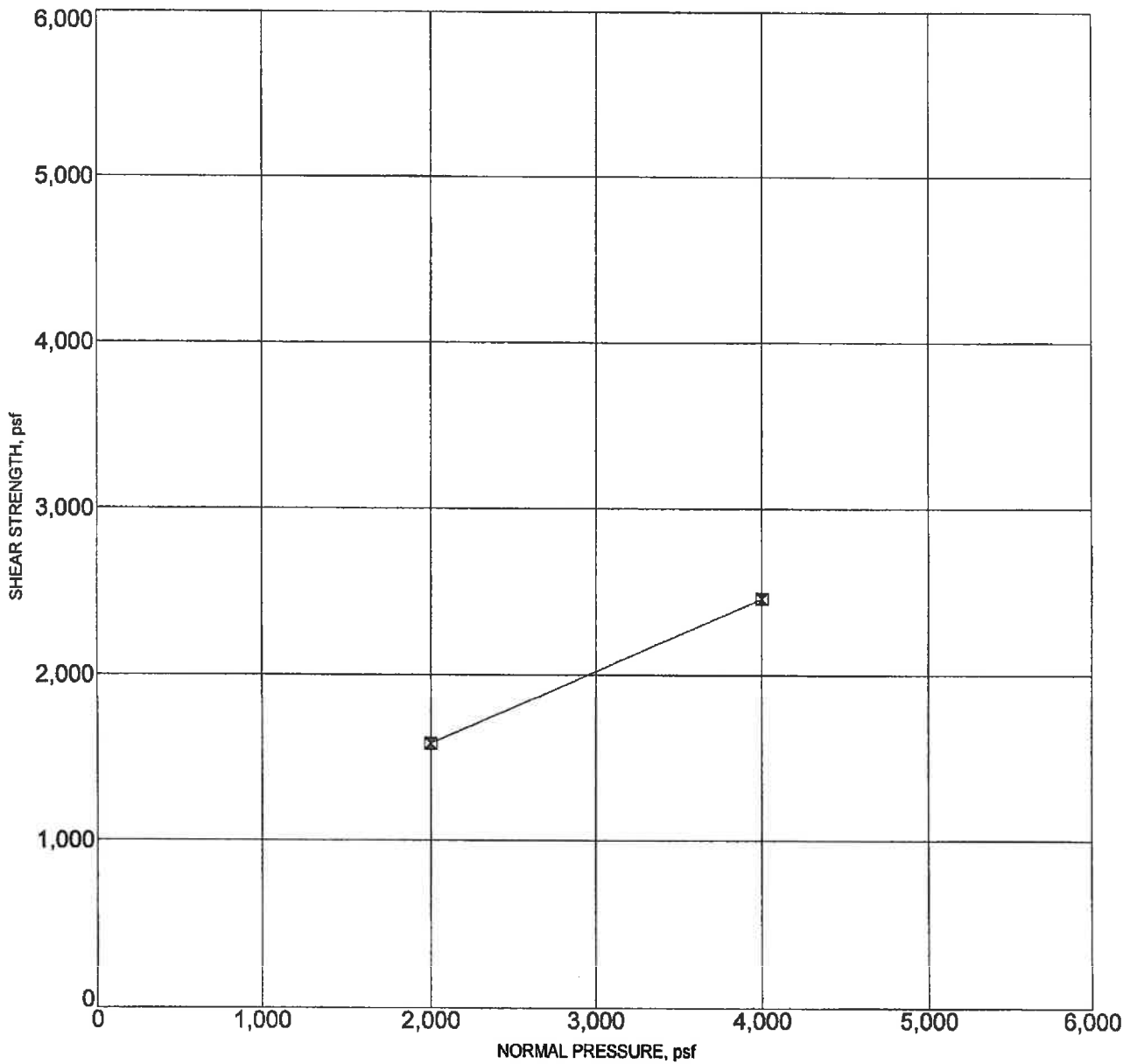

☒ RESIDUAL STRENGTH
 Friction Angle= 24 degrees
 Cohesion= 708 psf

Sample Location	Classification	DD,pcf	MC,%
B-4 20.0	SILTSTONE	55	67.7

PROJECT: HARVARD-WESTLAKE

PROJECT NO.: 2270.1



DIRECT SHEAR TEST RESULTS

FIGURE B-8

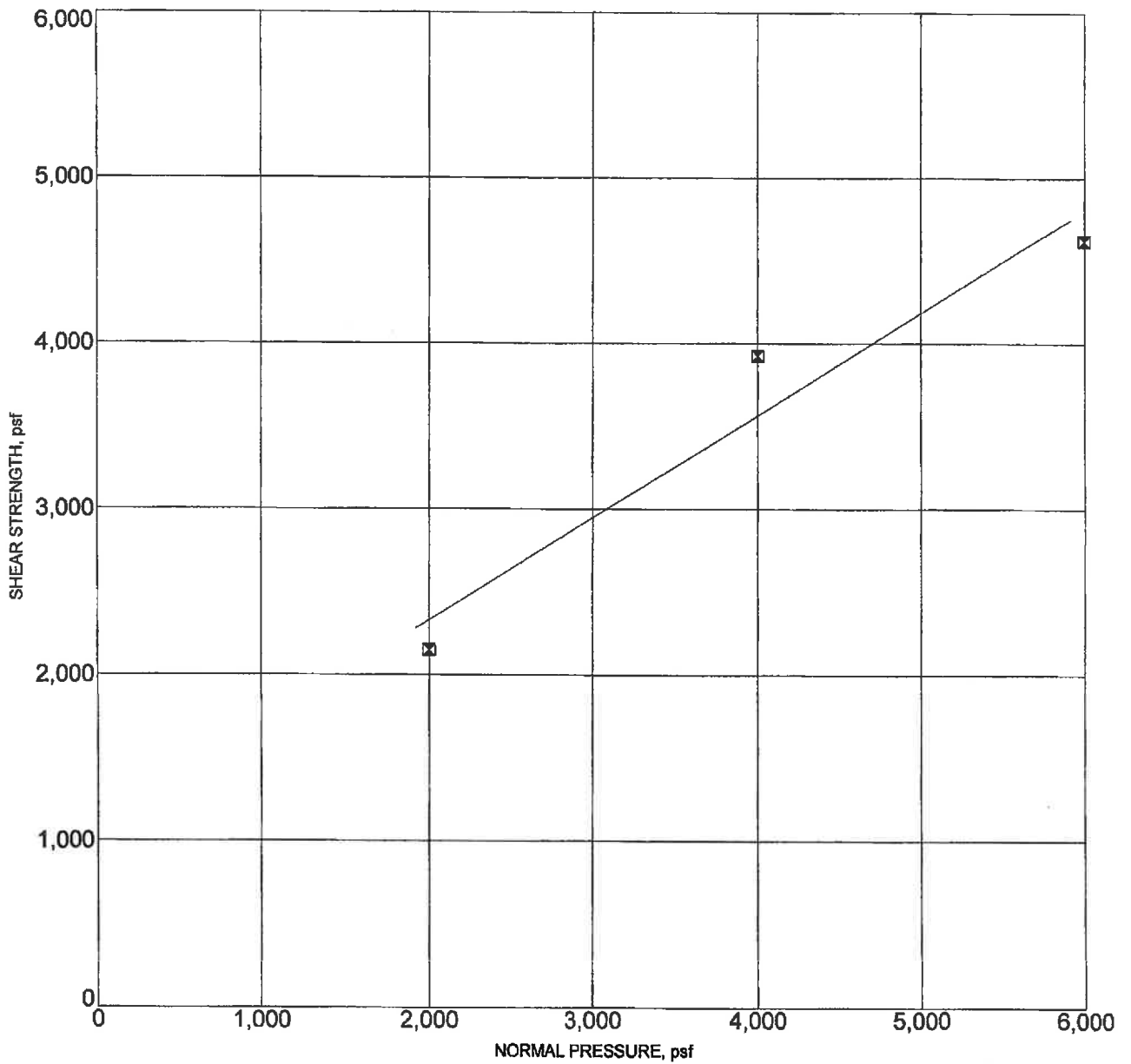

x RESIDUAL STRENGTH
 Friction Angle= 32 degrees
 Cohesion= 1092 psf

Sample Location	Classification	DD,pcf	MC,%
B-4 65.0	SILTSTONE	57	63.0

PROJECT: HARVARD-WESTLAKE

PROJECT NO.: 2270.1



DIRECT SHEAR TEST RESULTS

FIGURE B-9

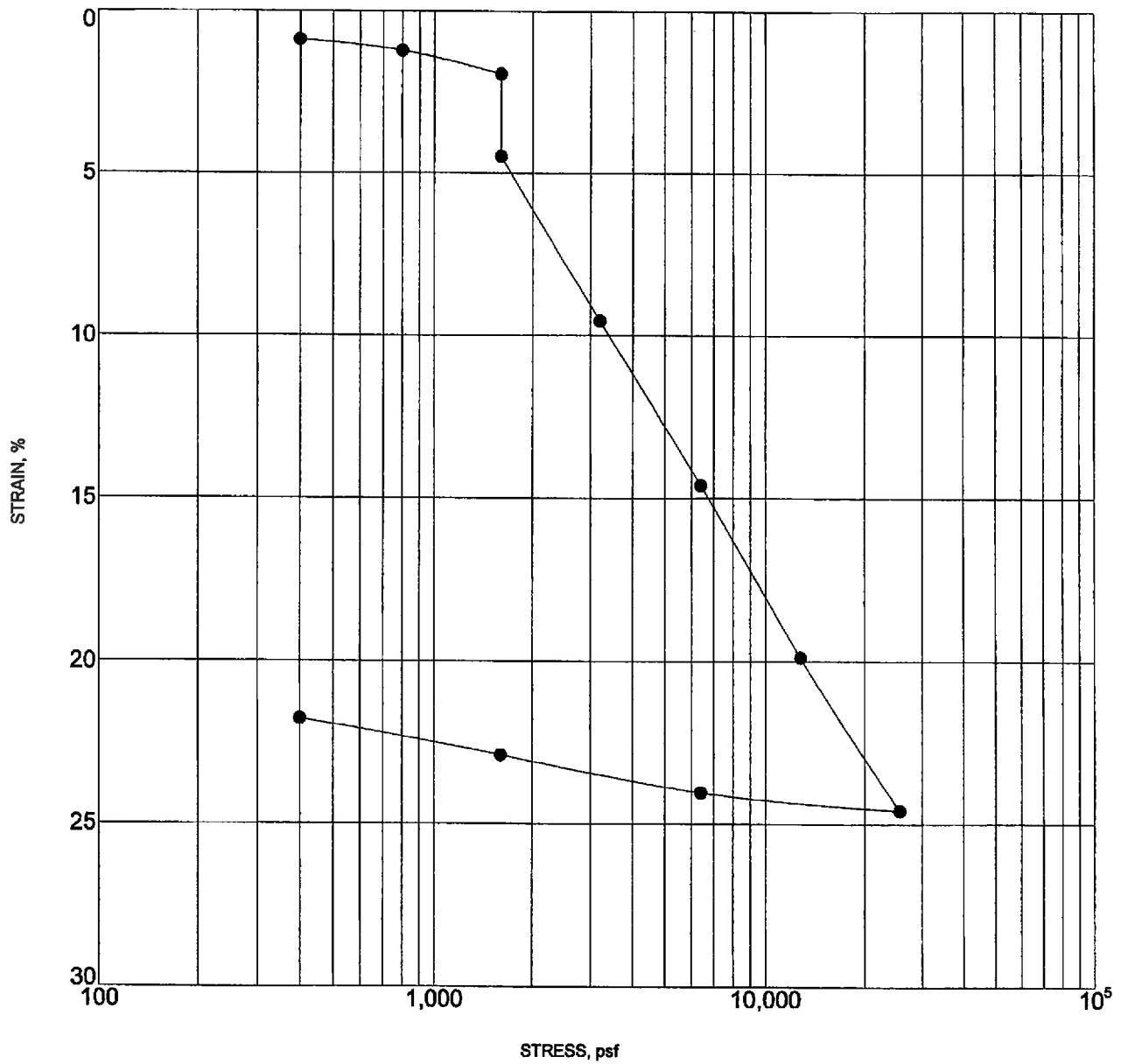

Sample inundated at 1600 psf

Sample Location	Classification	DD,pcf	MC,%
● B-2 10.0	SANDY SILT (MH)	64	20.4

PROJECT: HARVARD-WESTLAKE

PROJECT NO.: 2270.1



CONSOLIDATION TEST

FIGURE B-10

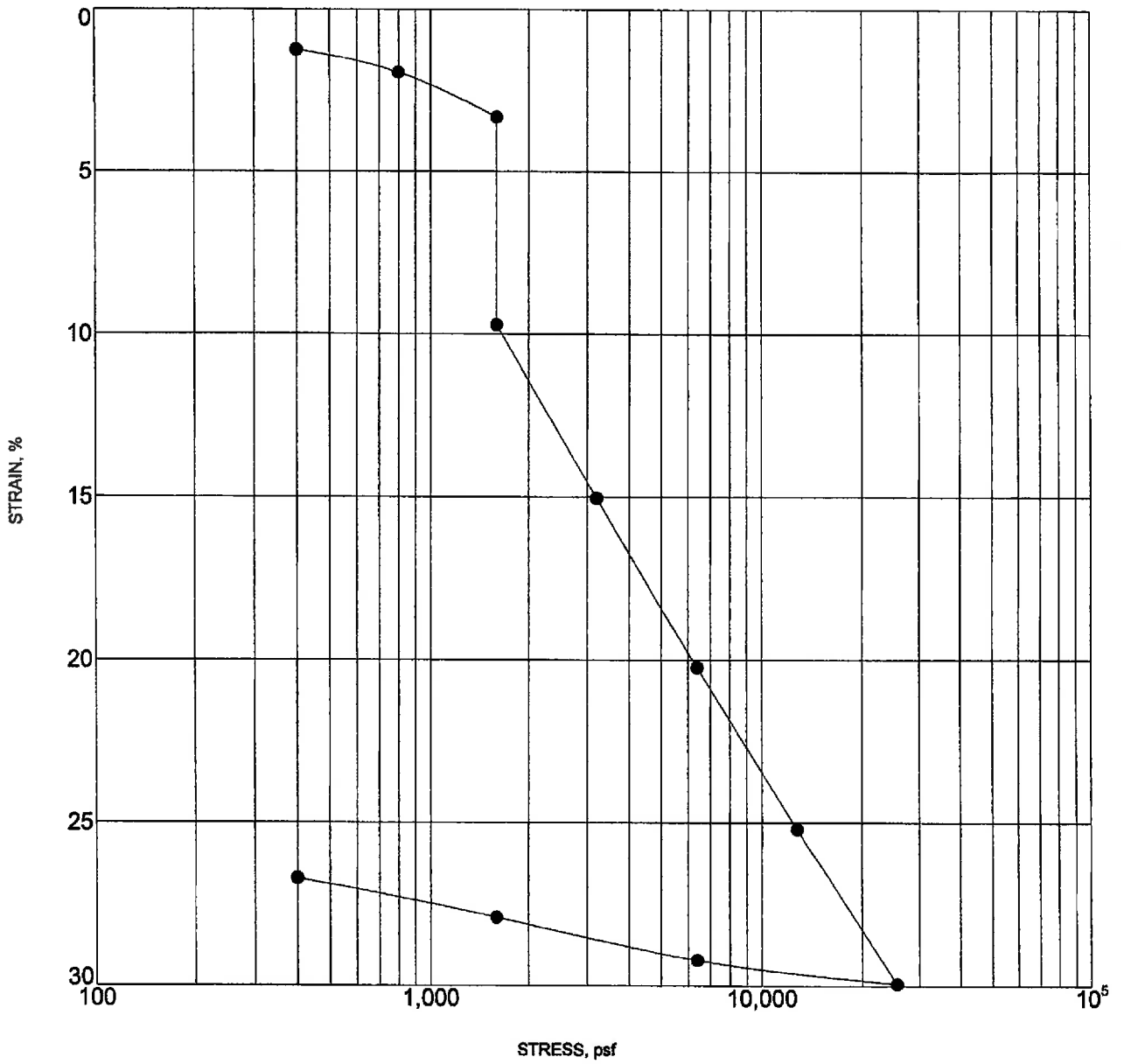

Sample inundated at 1600 psf

Sample Location	Classification	DD,pcf	MC,%
● B-2 20.0	SILT (MH)	63	22.8

PROJECT: HARVARD-WESTLAKE

PROJECT NO.: 2270.1



CONSOLIDATION TEST

FIGURE B-11

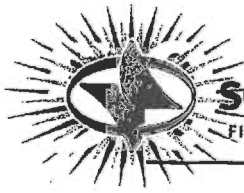
**Table 1 - Laboratory Tests on Soil Samples**

*Geotechnical Professionals Inc.
IDG Harvard
Your #2270.I, SA #09-1019LAB
30-Nov-09*

Sample ID		B2	B3
		@ 5-10'	@ 5-15'
Resistivity	Units		
as-received	ohm-cm	3,600	19,600
saturated	ohm-cm	600	760
pH		7.0	7.3
Electrical			
Conductivity	mS/cm	3.22	0.80
Chemical Analyses			
Cations			
calcium	Ca ²⁺ mg/kg	3,590	649
magnesium	Mg ²⁺ mg/kg	636	54
sodium	Na ¹⁺ mg/kg	588	113
potassium	K ¹⁺ mg/kg	86	99
Anions			
carbonate	CO ₃ ²⁻ mg/kg	ND	ND
bicarbonate	HCO ₃ ¹⁻ mg/kg	1,135	522
fluoride	F ¹⁻ mg/kg	3.4	11
chloride	Cl ¹⁻ mg/kg	55	264
sulfate	SO ₄ ²⁻ mg/kg	5,220	1,080
phosphate	PO ₄ ³⁻ mg/kg	ND	ND
Other Tests			
ammonium	NH ₄ ¹⁺ mg/kg	42	15
nitrate	NO ₃ ¹⁻ mg/kg	104	16
sulfide	S ²⁻ qual	na	na
Redox	mV	na	na

Electrical conductivity in millisiemens/cm and chemical analysis were made on a 1:5 soil-to-water extract.

mg/kg = milligrams per kilogram (parts per million) of dry soil.

Redox = oxidation-reduction potential in millivolts

ND = not detected

na = not analyzed

February 5, 2013
(Revised February 6, 2013)

Innovative Design Group
17848 Sky Park Circle, Suite D
Irvine, California 92614

Attention: Mr. Steve Kuhn

Subject: Update Letter
Geotechnical Investigation
Proposed Parking Structure
Harvard-Westlake School
3700 Coldwater Canyon Avenue
Los Angeles, California
GPI Project No. 2270.C

Dear Mr. Kuhn:

This letter updates our preliminary geotechnical investigation report (Reference 1) dated July 27, 2010 for the parking structure planned at Harvard-Westlake School in Los Angeles, California. Reference 1 addressed a 4 level (3 suspended decks) parking structure that encroaches into an ascending slope adjacent to Coldwater Canyon Avenue.

We understand that the design level grading and structural plans have yet to be completed for the design of the parking structure and surrounding slopes. After completion of the geometry of the final design, we recommend a grading plan review be performed to include our final geotechnical design recommendations.

The recommendations contained in our geotechnical investigation report (Reference 1) remain applicable for new parking structure proposed for the site except as follows:

- We assume the seismic design of the proposed development will be in accordance with the California Building Code, 2010 edition. For the 2010 CBC, a Soil Class C may be used.
- Based on the USGS website (Reference 2), we computed that the site could be subject to a peak ground acceleration of 0.40g. This acceleration has been computed using 40 percent of the short period design spectral acceleration, S_{DS} , for the project.
- A seismic increment of 12H in pounds per square foot (where H is equal to the height of the wall) may be added to the static lateral earth pressures to estimate seismic loading. The seismic earth pressure was estimated using the Mononobe-

2270-C-01L.doc (2/13)

Okabe method and a pseudo-static coefficient of 0.15g, which is approximately one-third of the design acceleration.

We trust this information satisfies the requirements of the design team and the City of Los Angeles to update our previous report for this project.

Please do not hesitate to call if you have any questions on the contents of this letter.

Respectfully submitted,
Geotechnical Professionals Inc.

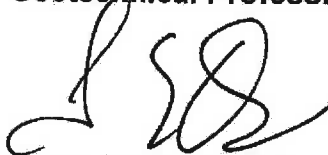

James E. Harris, G.E.
Principal



JEH:sph

FEB - 6 2013

Enclosures: References

Distribution: (1) Addressee
(4) Mr. Michael Nytzen, Paul Hastings LLP

REFERENCES

1. Geotechnical Professionals, Inc., "Preliminary Geotechnical Investigation, Proposed Parking Structure, Harvard-Westlake School, 3700 Coldwater Canyon Avenue, Los Angeles, California," GPI Project No. 2270.I, dated July 27, 2010.
2. United States Geological Survey, "Seismic Design Values for Buildings, Seismic Hazard Mapping, Research and Monitoring, Website Address: <http://earthquake.usgs.gov/research/hazmaps/design/index.php>

May 18, 2015
BG 21898

APPENDIX III

The J. Byer Group, Inc. (JB17973-B), excerpts from reports dated February 22 and
March 4, 1999

APPENDIX I

LABORATORY TESTING

Undisturbed and bulk samples of the compacted fill, fill, soil, alluvium and bedrock were obtained from the test pits and borings and transported to the laboratory for testing and analysis. The samples were obtained by driving a ring lined barrel sampler conforming to ASTM D-3550 with successive drops of the Kelly bar and hand sampler weight. Experience has shown that sampling causes some disturbance of the sample, however the test results remain within a reasonable range. The samples were retained in brass rings of 2.50 inches outside diameter and 1.00 inches in height. The samples were stored in close fitting, waterproof containers for transportation to the laboratory.

Moisture-Density

The dry density of the samples was determined using the procedures outlined in ASTM D-2937. The moisture content of the samples was determined using the procedures outlined in ASTM D-2216. The results are shown on the Log of Test Pits and Log of Borings.

Shear-Tests

Shear tests were performed on samples of future compacted fill, soil, and bedrock using the procedures outlined in ASTM D-3080 and a strain controlled, direct shear machine manufactured by Soil Test, Inc. The rate of deformation was 0.025 for the bedrock and future compacted fill samples and 0.010 inches per minute for the soil samples. The samples were tested in an artificially saturated condition. Following the shear test, the moisture content of the samples was determined to verify saturation. The results are plotted on the "Shear Test Diagrams".

Consolidation

Consolidation tests were performed on insitu samples of the alluvium. Results are graphed on the "Consolidation Curves".

THE J. BYER GROUP, INC.

A GEOTECHNICAL CONSULTING FIRM

512 E. WILSON AVENUE SUITE 201, GLENDALE, CA 91206
 818•549•9959 Tel 818•543•3747 Fax

SHEAR TEST DIAGRAM

JB: **17973-B** Harvard - West Campus

SAMPLE: Soil

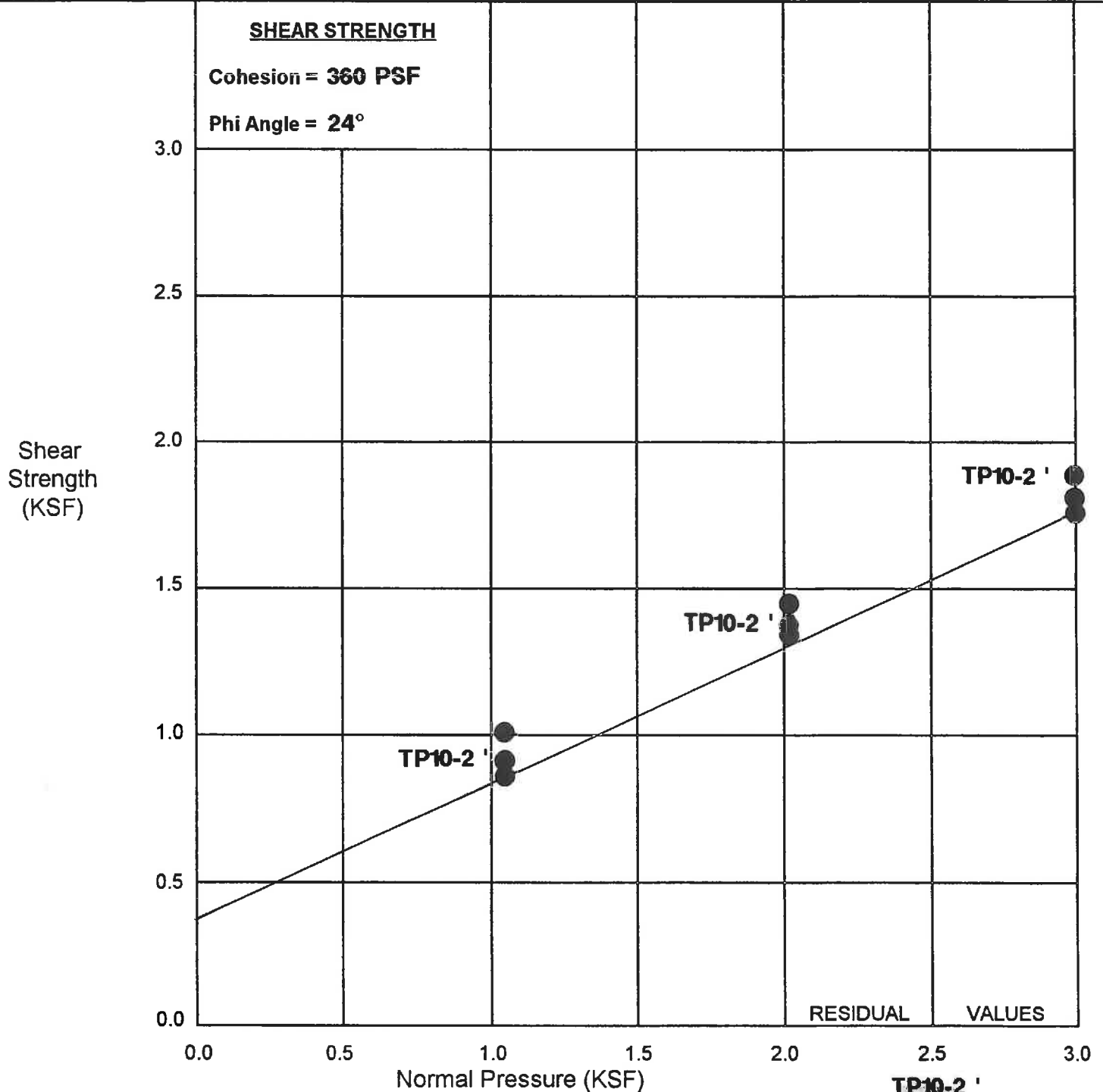

○ Direct Shear (Field Moisture)

● Direct Shear (Saturated)

Moisture Content (%) = **77.6**

Dry Density (pcf) = **57.9**

THE J. BYER GROUP, INC.

A GEOTECHNICAL CONSULTING FIRM

512 E. WILSON AVENUE SUITE 201, GLENDALE, CA 91206
 818•549•9959 Tel 818•543•3747 Fax

SHEAR TEST DIAGRAM

JB: **17973-B** Harvard - West Campus

SAMPLE: Bedrock

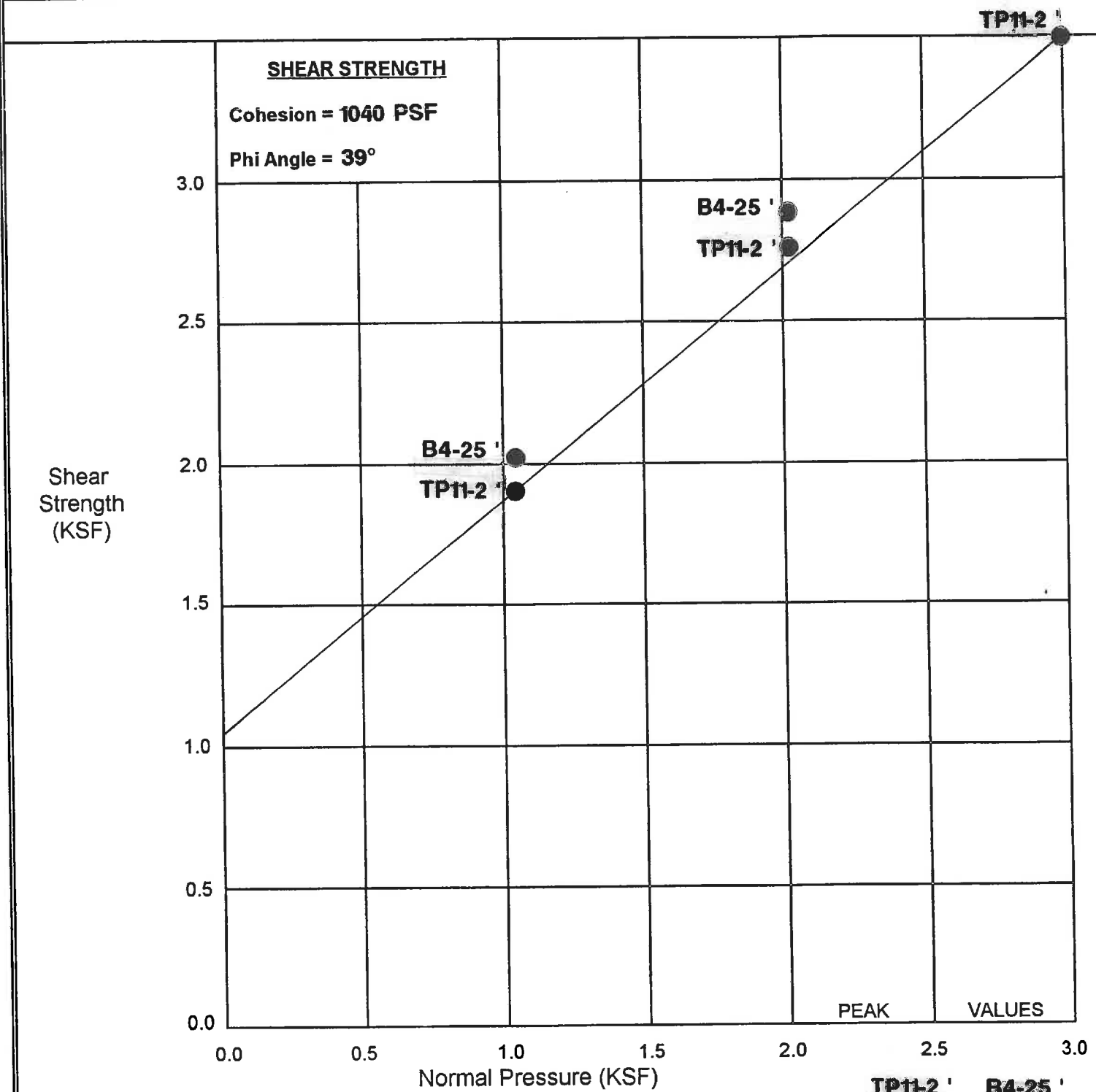

- Direct Shear (Field Moisture)
- Direct Shear (Saturated)

	TP11-2'	B4-25'
Moisture Content (%) =	85.9	44.5
Dry Density (pcf) =	42.1	74.6

THE J. BYER GROUP, INC.

A GEOTECHNICAL CONSULTING FIRM

512 E. WILSON AVENUE SUITE 201, GLENDALE, CA 91206
818•549•9959 Tel 818•543•3747 Fax

SHEAR TEST DIAGRAM

JB: 17973-B Harvard - West Campus

SAMPLE: Future Fill

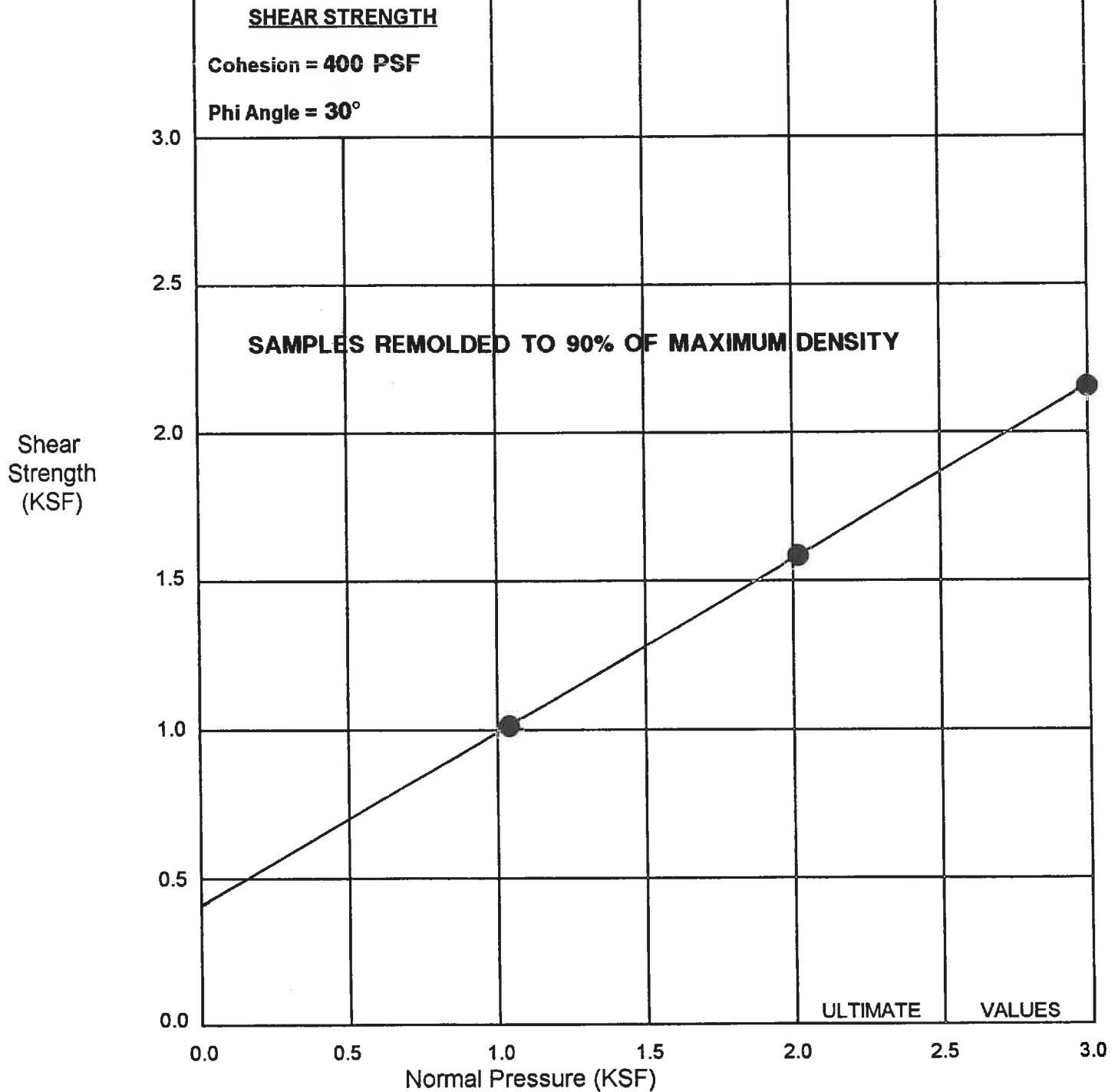

○ Direct Shear (Field Moisture)

Moisture Content (%) = 42

● Direct Shear (Saturated)

Dry Density (pcf) = 76.5

LOG OF TEST PITS

THE J. BYER GROUP, INC.

A GEOTECHNICAL CONSULTING FIRM

512 E. WILSON AVENUE SUITE 201, GLENDALE, CA 91206
818-549-9959 Tel 818-543-3747 Fax

JB: 17973-B

CLIENT: HARVARD-WEST CAMPUS

GEOLOGIST: JET

DATE LOGGED: 12/22/98

EXCAVATION METHOD: Back Hoe

REPORT DATE: 2/24/99

TEST PIT #1

Surface Conditions: Toe of Slope Elevation: 760

SAMPLE DEPTH (feet)	MOISTURE CONTENT (%)	DRY DENSITY (pcf)	DEPTH INTERVAL (feet)	EARTH MATERIAL	LITHOLOGIC DESCRIPTION
			0 - 2	SOIL:	Sandy Silt, medium to dark brown, slightly moist, soft, porous, rock fragments up to 4 inches
			2 - 3		Gravelly Silt, gray brown, slightly moist, firm, porous
			3 - 5 1/2	BEDROCK:	Diatomaceous, Siltstone, white, light gray, light tan, moderately hard, bedding near vertical, thinly bedded, diatomaceous Bedding at 4 1/2 feet: N62E; 71N.

End at 5 1/2 Feet; No Water; No Caving; No Fill.

TEST PIT #2

Surface Conditions: Toe of Slope Elevation: 780

			0 - 6	ALLUVIUM:	Sandy Silt, Silty Sand, brown to dark brown, slightly moist, slightly firm, porous, siltstone fragments up to 1 foot, roots up to 2 inches
			6 - 8	BEDROCK:	Diatomaceous, Siltstone, orange, white, gray, tan, moderately hard, fractured, very weathered
			8 - 10		white, gray, tan, moderately hard, thinly bedded Bedding at 9 Feet; N73E; 74N

End at 10 Feet; No Water; No Caving; No Fill.

TEST PIT #3

Surface Conditions: Toe of Slope Elevation: 760

			0 - 1/2	SOIL:	Sandy Silt, brown, gray, slightly moist, medium firm, porous, rootlets
			1/2 - 3	BEDROCK:	Diatomaceous, Siltstone, gray to brown, gray to light tan, moderately hard, slightly fractured, rootlets along fractured, thinly bedded
			3 - 6		hard, no fractures N69E; 64N N72E; 69N at 5 Feet

End at 6 Feet; No Water; No Caving; No Fill.

NOTE: The stratification depths shown on the Log of Test Pits are approximate and are based upon visual classification of samples and cuttings. The actual depths may vary. Variations between test pits may also occur.

THE J. BYER GROUP, INC.

A GEOTECHNICAL CONSULTING FIRM

512 E. WILSON AVENUE SUITE 201, GLENDALE, CA 91206
818-549-9959 Tel 818-543-3747 Fax

LOG OF TEST PITS

JB: 17973-B

CLIENT: HARVARD-WEST
CAMPUS

GEOLOGIST: JET

DATE LOGGED: 12/22/98

EXCAVATION METHOD: Back Hoe

REPORT DATE: 2/24/99

TEST PIT #4

Surface Conditions: Toe of Slope Elevation: 760

SAMPLE DEPTH (feet)	MOISTURE CONTENT (%)	DRY DENSITY (pcf)	DEPTH INTERVAL (feet)	EARTH MATERIAL	LITHOLOGIC DESCRIPTION
			0 - 1 ½	COMPACTED FILL:	Sandy Silt, dark gray brown, slightly moist, firm, rock fragments up to 8 inches
			1 ½ - 11	ALLUVIUM:	Sandy Silt, gray brown, slightly moist to moist, firm, porous, rock fragments to 6 inches
			11 - 12 ½	BEDROCK:	Diatomaceous, Siltstone, white, buff to light brownish gray, moderately hard, fractured, weathered
			12 ½ - 14		Hard, slightly fractured, thinly bedded. Bedding at 3 Feet: N80E; 65N

End at 14 Feet; No Water; No Caving; Fill to 1 ½ Feet.

TEST PIT #5

Surface Conditions: Slope Elevation: 765

			0 - 2	SOIL:	Sandy Silt, brownish gray, slightly moist, firm, porous, some gravel roots to ½
			2 - 4		rock fragments to 12 inches
			4 - 5 ½	BEDROCK:	Diatomaceous Siltstone, gray to brownish gray, moderately hard, fractured, roots up to ¼ inch along fractures
			5 ½ - 7		hard, not fractured, thinly bedded Bedding at 6 Feet: N74E; 61N

End at 7 Feet; No Water; No Caving; No Fill.

NOTE: The stratification depths shown on the Log of Test Pits are approximate and are based upon visual classification of samples and cuttings. The actual depths may vary. Variations between test pits may also occur.



THE J. BYER GROUP, INC.

A GEOTECHNICAL CONSULTING FIRM

512 E. WILSON AVENUE SUITE 201, GLENDALE, CA 91206
818-549-9959 Tel 818-543-3747 Fax

LOG OF TEST PITS

JB: 17973-B

CLIENT: HARVARD-WEST
CAMPUS

GEOLOGIST: JET

DATE LOGGED: 12/29/98

EXCAVATION METHOD: Hand Dug

REPORT DATE: 2/24/99

TEST PIT #6

Surface Conditions: Slope Elevation: 750

SAMPLE DEPTH (feet)	MOISTURE CONTENT (%)	DRY DENSITY (pcf)	DEPTH INTERVAL (feet)	EARTH MATERIAL	LITHOLOGIC DESCRIPTION
			0 - 1½	SOIL:	Sandy Silt, gray brown, dry, slightly firm, very porous, roots to 1 inch, burrows
			1½ - 4¼		slightly moist, firm, porous, some gravel
			4¼ - 6½	BEDROCK:	Diatomaceous Siltstone, buff to light gray brown, moderately hard to hard, well bedded Bedding at 5 Feet: N64E; 71N

End at 6½ Feet; No Water; No Caving; No Fill.

TEST PIT #7

Surface Conditions: Slope Elevation: 725

			0 - ½	SOIL:	
			½ - 2½	BEDROCK:	Diatomaceous Siltstone, buff to light gray brown, hard Bedding at 1½ Feet: N72E; 64N

End at 2½ Feet; No Water; No Caving; No Fill.

TEST PIT #8

Surface Conditions: Slope Elevation: 735

			0 - 1½	FILL:	Sandy Silt, light brownish gray, dry, soft, rootlets, some gravel, burrows
8	18.4	58.1	1½ - 6	SOIL:	Sandy Silt, brownish gray to dark brownish gray, slightly moist, slightly firm to firm, slightly porous, roots to 1 inch
			6 - 7½	BEDROCK:	Diatomaceous Siltstone, light gray to light greenish gray, moderately hard to hard, thinly bedded, Bedding at 7 Feet: N66E; 68N

End at 7½ Feet; No Water; No Caving; Fill to 1½ Feet.

NOTE: The stratification depths shown on the Log of Test Pits are approximate and are based upon visual classification of samples and cuttings. The actual depths may vary. Variations between test pits may also occur.



THE J. BYER GROUP, INC.

A GEOTECHNICAL CONSULTING FIRM

512 E. WILSON AVENUE SUITE 201, GLENDALE, CA 91206
818-549-9959 Tel 818-543-3747 Fax

LOG OF TEST PITS

JB: 17973-B

CLIENT: HARVARD-WEST
CAMPUS

GEOLOGIST: JET

DATE LOGGED: 12/29/98

EXCAVATION METHOD: Hand Dug

REPORT DATE: 2/24/99

TEST PIT #9

Surface Conditions: Toe of Slope Elevation: 720

SAMPLE DEPTH (feet)	MOISTURE CONTENT (%)	DRY DENSITY (pcf)	DEPTH INTERVAL (feet)	EARTH MATERIAL	LITHOLOGIC DESCRIPTION
2½	21.9	63.2	0 - 1½	SOIL:	Sandy Silt, brownish gray, dry, soft to slightly firm, porous, burrows
			1½ - 5		dark brownish gray to black, slightly moist to moist, slightly firm to firm, slightly porous to porous, rock fragments up to 6 inches, some clay, roots to 1 inch
			5 - 6	BEDROCK:	Siltstone, buff, soft, very weathered, fractured
			6 - 7		brown to greenish gray, moderartely hard to hard, slightly weathered, fractured, gypsum along fractures Bedding at 6½ Feet: N67E; 88S

End at 7 Feet; No Water; No Caving; No Fill.

TEST PIT #10

Surface Conditions: Level Elevation: 760

2	21.7	57.9	0 - 1	FILL:	Sandy Silt, dark brownish gray, dry, soft, rootlets, some gravel
			1 - 4	SOIL:	Sandy Silt, brownish gray, dry, firm to very firm, porous, burrows
			4 - 5½	BEDROCK:	Diatomaceous Siltstone, gray brown to brown to tan, soft, very weathered, fractured gypsum along fractures
6½	76.4	38.8	5½ - 6½		buff to light brown, moderately hard, bedded, slightly weathered, slightly fractured Bedding at 5½ Feet: N74E; 64S

End at 6½ Feet; No Water; No Caving; Fill to 1 Foot.

TEST PIT #11

Surface Conditions: Slope Elevation: 825

2	58.9	42.1	0 - 1	SOIL:	Sandy Silt, light brownish gray, dry to slightly moist, slightly firm, slightly porous, rootlets
			1 - 3	BEDROCK:	Diatomaceous Siltstone, white to buff to light brownish gray, moderately hard to hard Bedding at 2 Feet: N62E; 64NW Bedding at 2½ Feet: N65E; 62NW

End at 3 Feet; No Water; No Caving; No Fill.

NOTE: The stratification depths shown on the Log of Test Pits are approximate and are based upon visual classification of samples and cuttings. The actual depths may vary. Variations between test pits may also occur.

Project No: JB 17973-B

Log of Boring 1



The J. Byer Group, Inc.
 512 East Wilson Ave., Suite 201
 Glendale, CA 91206
 (818) 549-9959

Client: HARVARD-WESTLAKE

Location: West Campus

By: JET

SUBSURFACE PROFILE

Elevation	Depth	Description	Symbol	USCS	Type	Blow Count Per Foot	Moisture Content (%)	Dry Density (pcf)	% Saturation	Remarks
760	0	Ground Surface								
		COMPACTED FILL								
759	1	Sandy Silt, light brownish gray, dry to slightly moist, firm								
758	2									
		BEDROCK								
757	3	Diatomaceous Siltstone, brownish gray to gray, moderately hard, slightly fractured, thinly bedded, rootlets along fractures								
756	4	hard, no fractures								
		Bedding at 4½ feet: N70E; 67NW								
755	5									
754	6									
753	7									
752	8									
751	9	Jointing at 9 Feet: N13W; 55NE								
750	10	Bedding at 10 Feet: N66E; 69NW			R	4	74.1	51.8		
749	11									
748	12									
747	13	4 Inch diameter concretion, dark brown, very hard								
746	14									
745	15	Bedding at 15 Feet: N67E; 71NW								
744	16	light brown to gray brown								
743	17									
742	18									
741	19									
740	20									

Surface: Level Pad

Drill Method: Bucket Auger

Drill Date: 12/23/98

Size: 24 Inch

Elevation: 760

Sheet: 1 of 2

Project No: JB 17973-B

Log of Boring 1

The J. Byer Group, Inc.
 512 East Wilson Ave., Suite 201
 Glendale, CA 91206
 (818) 549-9959

Client: HARVARD-WESTLAKE

Location: West Campus

By: JET

SUBSURFACE PROFILE

Elevation	Depth	Description	Symbol	USCS	Type	Blow Count Per Foot	Moisture Content (%)	Dry Density (pcf)	% Saturation	Remarks
739	21		xxxxxx xxxxxx xxxxxx xxxxxx xxxxxx xxxxxx xxxxxx	---	R	7	81.6	54.6		
738	22	Jointing at 22 Feet: N16W; 62NE	xxxxxx xxxxxx xxxxxx xxxxxx xxxxxx xxxxxx xxxxxx							
737	23	Bedding at 23 Feet: N73E; 69NW	xxxxxx xxxxxx xxxxxx xxxxxx xxxxxx xxxxxx xxxxxx							
736	24		xxxxxx xxxxxx xxxxxx xxxxxx xxxxxx xxxxxx xxxxxx							
735	25	dark gray brown to dark gray	xxxxxx xxxxxx xxxxxx xxxxxx xxxxxx xxxxxx xxxxxx							
734	26	Bedding at 26 Feet: N70E; 67NW	xxxxxx xxxxxx xxxxxx xxxxxx xxxxxx xxxxxx xxxxxx							
733	27		xxxxxx xxxxxx xxxxxx xxxxxx xxxxxx xxxxxx xxxxxx	---	R	7	29.9	87.2		
732	28		xxxxxx xxxxxx xxxxxx xxxxxx xxxxxx xxxxxx xxxxxx							
731	29		xxxxxx xxxxxx xxxxxx xxxxxx xxxxxx xxxxxx xxxxxx							
730	30	End at 30 Feet; No Water; No Caving; Fill to 2½ Feet.	xxxxxx xxxxxx xxxxxx xxxxxx xxxxxx xxxxxx xxxxxx							
729	31									
728	32									
727	33									
726	34									
725	35									
724	36									
723	37									
722	38									
721	39									
720	40									

Surface: Level Pad

Size: 24 Inch

Drill Method: Bucket Auger

Elevation: 760

Drill Date: 12/23/98

Sheet: 2 of 2

Project No: JB 17973-B

Log of Boring 2

The J. Byer Group, Inc.
 512 East Wilson Ave., Suite 201
 Glendale, CA 91206
 (818) 549-9959

Client: HARVARD-WESTLAKE

Location: West Campus

By: JET

SUBSURFACE PROFILE

Elevation	Depth	Description	Symbol	USCS	Type	Blow Count Per Foot	Moisture Content (%)	Dry Density (pcf)	% Saturation	Remarks
765	0	Ground Surface								
		ALLUVIUM								
764	1	Silt, dark gray brown, slightly moist, slightly soft, very porous, roots to 1½ inches and rock fragments to 4 inches	[Cross-hatched symbol]							
763	2									
762	3									
761	4	firm, some gravel, roots to ¼ inch, slightly porous to porous								
760	5			—	R	3	26.8	85.5		
759	6									
758	7									
757	8									
756	9									
755	10									
754	11									
753	12	Gravelly Silt, gray to dark gray brown, firm, rock fragments to 6 inches	[Dotted symbol]							
752	13									
751	14	Silt, dark grayish brown, slightly firm, porous								
750	15			---	R	6	25.5	83.4		
749	16	firm, light grayish brown to dark grayish brown porous								
748	17									
747	18									
746	19	light gray brown, firm to very firm, rock fragments to 6 inches								
745	20									

Surface: Level

Drill Method: Bucket Auger

Drill Date: 12/23/98

Size: 24 Inch

Elevation: 765

Sheet: 1 of 2

Project No: JB 17973-B

Log of Boring 2

The J. Byer Group, Inc.
 512 East Wilson Ave., Suite 201
 Glendale, CA 91206
 (818) 549-9959

Client: HARVARD-WESTLAKE

Location: West Campus

By: JET

SUBSURFACE PROFILE

Elevation	Depth	Description	Symbol	USCS	Type	Blow Count Per Foot	Moisture Content (%)	Dry Density (pcf)	% Saturation	Remarks
744	21	BEDROCK	XXXXXX	---	R	4	32.5	76.3		
743	22	Diatomaceous Siltstone, light brown, soft, ver weathered, soil filled fractured up to 1 inch, some gypsum along fractures	XXXXXX							
742	23		XXXXXX							
741	24	light brown and gray, moderately hard to hard, slightly fractured, some gypsum veins along bedding and fractures	XXXXXX							
740	25	Jointing at 24½ Feet: N10W; 32NE	XXXXXX							
739	26	Bedding at 26 Feet: N73E; 76NW	XXXXXX							
738	27		XXXXXX							
737	28	Bedding at 27½ Feet: N75E; 78NW	XXXXXX							
736	29		XXXXXX							
735	30	End at 30 Feet; No Water; No Caving; No Fill.	XXXXXX	---	R	12	50.0	67.9		
734	31									
733	32									
732	33									
731	34									
730	35									
729	36									
728	37									
727	38									
726	39									
725	40									

Surface: Level

Drill Method: Bucket Auger

Drill Date: 12/23/98

Size: 24 Inch

Elevation: 765

Sheet: 2 of 2

Project No: JB 17973-B

Log of Boring 3

The J. Byer Group, Inc.
 512 East Wilson Ave., Suite 201
 Glendale, CA 91206
 (818) 549-9959

Client: HARVARD-WESTLAKE

Location: West Campus

By: JET

SUBSURFACE PROFILE

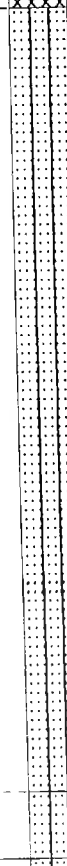
Elevation	Depth	Description	Symbol	USCS	Type	Blow Count Per Foot	Moisture Content (%)	Dry Density (pcf)	% Saturation	Remarks	
755	0	Ground Surface									
		COMPACTED FILL									
754	1	Sandy Silt, light brownish gray to dark grayish brown, slightly moist, firm, rock fragments to 4 inches, rootlets									
753	2										
752	3										
751	4										
750	5			---	R	4	40.5	64.8			
749	6										
748	7	very firm, moist, some gravel									
747	8										
746	9										
745	10				---	R	3	26.4	86.7		
744	11										
743	12										
742	13										
741	14										
740	15				---	R	4	29.9	86.9		
739	16										
738	17										
737	18										
736	19	dark brownish gray									
735	20										

Surface: Level Pad

Drill Method: Bucket Auger

Drill Date: 12/23/98

Size: 24 Inch

Elevation: 755

Sheet: 1 of 3

Project No: JB 17973-B

Log of Boring 3

Client: HARVARD-WESTLAKE

The J. Byer Group, Inc.
512 East Wilson Ave., Suite 201
Glendale, CA 91206
(818) 549-9959

Location: West Campus

By: JET

SUBSURFACE PROFILE

Elevation	Depth	Description	Symbol	USCS	Type	Blow Count Per Foot	Moisture Content (%)	Dry Density (pcf)	% Saturation	Remarks
734	21	ALLUVIUM: Sandy Silt, dark gray brown, moist, firm, some gravel, porous	[Symbol]	---	R	3	27.2	92.9		
733	22		[Symbol]	---	R	4	25.2	95.1		
732	23		[Symbol]							
731	24		[Symbol]							
730	25		[Symbol]	---	R	3	27.3	89.1		
729	26		[Symbol]							
728	27		[Symbol]	---	R	7	27.4	86.9		
727	28		[Symbol]							
726	29	Gravelly Silt, light brownish gray to tan, moist, firm, rock fragments to 6 inches, slightly porous	[Symbol]							
725	30	dark grayish brown, very firm, some clay	[Symbol]	---	R	8	28.8	82.0		
724	31		[Symbol]							
723	32		[Symbol]							
722	33	gray brown to tan	[Symbol]							
721	34		[Symbol]							
720	35	dark gray brown, porous	[Symbol]	---	R	5	46.1	77.1		
719	36		[Symbol]							
718	37		[Symbol]							
717	38	BEDROCK Diatomaceous Siltstone, tan to light gray brown, moderately hard to hard, thinly bedded	[Symbol]							
716	39	Bedding at 38½ Feet: N70E; 67NW Jointing at 39 Feet: N23W; 65NE	[Symbol]							
715	40		[Symbol]							

Surface: Level Pad

Drill Method: Bucket Auger

Drill Date: 12/23/98

Size: 24 Inch

Elevation: 755

Sheet: 2 of 3

Project No: JB 17973-B

Log of Boring 3

The J. Byer Group, Inc.
512 East Wilson Ave., Suite 201
Glendale, CA 91206
(818) 549-9959

Client: HARVARD-WESTLAKE

Location: West Campus

By: JET

SUBSURFACE PROFILE

Elevation	Depth	Description	Symbol	USCS	Type	Blow Count Per Foot	Moisture Content (%)	Dry Density (pcf)	% Saturation	Remarks
714	41	End at 41 Feet; No Water; No Caving; Fill to 20 Feet	XXXXXX XXXXXX XXXXXX	---	R	11	94.1	45.1		
713	42									
712	43									
711	44									
710	45									
709	46									
708	47									
707	48									
706	49									
705	50									
704	51									
703	52									
702	53									
701	54									
700	55									
699	56									
698	57									
697	58									
696	59									
695	60									

Surface: Level Pad

Size: 24 Inch

Drill Method: Bucket Auger

Elevation: 755

Drill Date: 12/23/98

Sheet: 3 of 3

Project No: JB 17973-B

Log of Boring 4

The J. Byer Group, Inc.
 512 East Wilson Ave., Suite 201
 Glendale, CA 91206
 (818) 549-9959

Client: HARVARD-WESTLAKE

Location: West Campus

By: JET

SUBSURFACE PROFILE

Elevation	Depth	Description	Symbol	USCS	Type	Blow Count Per Foot	Moisture Content (%)	Dry Density (pcf)	% Saturation	Remarks
756	0	Ground Surface								
		COMPACTED FILL								
755	1	Sandy Silt, dark brown, moist, firm, some gravel, some clay	[Cross-hatched symbol]							
754	2									
753	3									
752	4									
751	5	Gravelly Silt, light grayish brown to tan, moist, firm, rock fragments to 6 inches	[Dotted symbol]							
750	6									
749	7	Sandy Silt, dark gray brown, moist, firm	[Vertical line symbol]							
748	8									
747	9	ALLUVIUM Sandy Silt, light gray brown, moist to very moist, very firm, some clay, slightly porous	[Vertical line symbol]							
746	10			---	R	3	28.7	89.6		
745	11									
744	12									
743	13									
742	14									
741	15	Gravelly Silt, tan to dark grayish brown, moist, slightly firm to firm, rock fragments to 8 inches	[Dotted symbol]							
740	16									
739	17	BEDROCK Siltstone, gray to light gray brown, loose, very weathered, very fractured, soil along fractures	[X symbol]							
738	18	light gray brown, moderately hard, thinly bedded, slightly fractured	[X symbol]							
737	19	Bedding at 19 Feet: N65E; 58NW	[X symbol]							
736	20		[X symbol]							

Surface: Level Pad

Drill Method: Bucket Auger

Drill Date: 12/23/98

Size: 24 Inch

Elevation: 756

Sheet: 1 of 2

Project No: JB 17973-B

Log of Boring 4

The J. Byer Group, Inc.
 512 East Wilson Ave., Suite 201
 Glendale, CA 91206
 (818) 549-9959

Client: HARVARD-WESTLAKE

Location: West Campus

By: JET

SUBSURFACE PROFILE

Elevation	Depth	Description	Symbol	USCS	Type	Blow Count Per Foot	Moisture Content (%)	Dry Density (pcf)	% Saturation	Remarks
735	21	hard	xxxxxx							
		Bedding at 21 Feet: N70E; 68NW	-----							
734	22		xxxxxx							
		Bedding at 22½ Feet: N66E; 66NW	-----							
733	23		xxxxxx							
			xxxxxx							
732	24		xxxxxx							
		End at 25 Feet; No Water; No Caving; Fill to 8½ Feet.	-----							
731	25		xxxxxx	----	R	6	42.9	74.6		
730	26									
729	27									
728	28									
727	29									
726	30									
725	31									
724	32									
723	33									
722	34									
721	35									
720	36									
719	37									
718	38									
717	39									
716	40									

Surface: Level Pad

Drill Method: Bucket Auger

Drill Date: 12/23/98

Size: 24 Inch

Elevation: 756

Sheet: 2 of 2

Project No: JB 17973-B

Log of Boring 5

The J. Byer Group, Inc.
 512 East Wilson Ave., Suite 201
 Glendale, CA 91206
 (818) 549-9959

Client: HARVARD-WESTLAKE

Location: West Campus

By: JET

SUBSURFACE PROFILE

Elevation	Depth	Description	Symbol	USCS	Type	Blow Count Per Foot	Moisture Content (%)	Dry Density (pcf)	% Saturation	Remarks
740	0	Ground Surface								
		FILL								
739	1	Sandy Silt, dark gray brown, slightly moist, medium firm, brick and concrete fragments								
738	2	ALLUVIUM								
737	3	Sandy Silt, dark gray brown, moist, firm to slightly firm, porous to very porous to porous, some gravel								
736	4									
735	5			---	R	2	26.6	58.0		
734	6									
733	7									
732	8	firm, slightly porous to porous								
731	9									
730	10	slightly firm, with rock fragments to 6 inches		---	R	1	28.2	57.9		
729	11									
728	12									
727	13									
726	14									
725	15			---	R	3	21.4	68.0		
724	16									
723	17									
722	18	firm to very firm								
721	19									
720	20									

Surface: Level

Drill Method: Bucket Auger

Drill Date: 12/28/98

Size: 24 Inch

Elevation: 740

Sheet: 1 of 2

Project No: JB 17973-B

Log of Boring 5

Client: HARVARD-WESTLAKE

The J. Byer Group, Inc.
512 East Wilson Ave., Suite 201
Glendale, CA 91206
(818) 549-9959

Location: West Campus

By: JET

SUBSURFACE PROFILE

Elevation	Depth	Description	Symbol	USCS	Type	Blow Count Per Foot	Moisture Content (%)	Dry Density (pcf)	% Saturation	Remarks
719	21	Gravelly Silt, whitish gray to grayish brown, slight moist to moist, firm, with rock fragments to 6 inches	[Symbol: Dotted pattern]	---	R	4	28.6	61.8		
718	22		[Symbol: Dotted pattern]							
717	23	BEDROCK	[Symbol: XXXXX pattern]							
716	24	Diatomaceous Siltstone, tan to light grayish brown, moderately hard, moderately weathered	[Symbol: XXXXX pattern]							
715	25	moderately hard to hard, slightly fractured, well bedded	[Symbol: XXXXX pattern]	---	R	7	34.6	78.8		
714	26	Bedding at 25½ Feet: N65E; 70NW	[Symbol: XXXXX pattern]							
713	27	hard, grayish brown to greenish brown	[Symbol: XXXXX pattern]							
712	28	Jointing at 27 Feet; N24W vertical	[Symbol: XXXXX pattern]							
711	29	Bedding at 28 Feet: N66E; 66NW	[Symbol: XXXXX pattern]							
710	30	End at 30 Feet; No Water; No Caving; Fill to 2 Feet.	[Symbol: XXXXX pattern]							
709	31									
708	32									
707	33									
706	34									
705	35									
704	36									
703	37									
702	38									
701	39									
700	40									

Surface: Level

Drill Method: Bucket Auger

Drill Date: 12/28/98

Size: 24 Inch

Elevation: 740

Sheet: 2 of 2

Project No: JB 17973-B

Log of Boring 6





The J. Byer Group, Inc.
 512 East Wilson Ave., Suite 201
 Glendale, CA 91206
 (818) 549-9959

Client: HARVARD-WESTLAKE

Location: West Campus

By: JET

SUBSURFACE PROFILE

Elevation	Depth	Description	Symbol	USCS	Type	Blow Count Per Foot	Moisture Content (%)	Dry Density (pcf)	% Saturation	Remarks
731	0	Ground Surface								
		FILL								
		Silty Sand, brown, moist, slightly dense								
730	1	Sandy Silt, dark gray brown, moist, firm, roots to ¼ inch, some gravey								
729	2									
728	3	ALLUVIUM								
		Sandy Silt, dark gray, brown, moist, firm, slightly porous, roots to 1 inch								
727	4									
726	5			---	R	2	23.1	65.6		
725	6	light gray brown to dark gray brown, slightly moist, slightly firm, roots to ¼ inch, porous								
724	7									
723	8									
722	9									
721	10			---	R	2	21.5	59.6		
720	11									
719	12									
718	13									
717	14									
716	15	rock fragments to 6 inches		---	R	2	23.3	65.2		
715	16									
714	17									
713	18									
712	19									
711	20									

Surface: Level

Drill Method: Bucket Auger

Drill Date: 12/28/98

Size: 24 Inch

Elevation: 731

Sheet: 1 of 3

Project No: JB 17973-B

Log of Boring 6

Client: HARVARD-WESTLAKE

The J. Byer Group, Inc.
512 East Wilson Ave., Suite 201
Glendale, CA 91206
(818) 549-9959

Location: West Campus

By: JET

SUBSURFACE PROFILE

Elevation	Depth	Description	Symbol	USCS	Type	Blow Count Per Foot	Moisture Content (%)	Dry Density (pcf)	% Saturation	Remarks
710	21	Gravelly Silt, light gray brown to gray brown to tan, slightly moist, firm, porous to very porous	[Symbol]	---	R	2	26.5	100.1		
709	22		[Symbol]							
708	23	very firm, rock fragments to 6 inches	[Symbol]							
707	24		[Symbol]							
706	25		[Symbol]	---	R	5	27.0	59.9		
705	26		[Symbol]							
704	27		[Symbol]							
703	28		[Symbol]							
702	29		[Symbol]							
701	30		[Symbol]	---	R	5	37.0	77.3		
700	31		[Symbol]							
699	32	light brown, tan to light gray brown, moist, very firm, rock fragments to 8 inches	[Symbol]							
698	33		[Symbol]							
697	34	dark gray brown	[Symbol]							
696	35	BEDROCK	[Symbol]	---	R	8	43.4	77.0		
695	36	Diatomaceous Siltstone, grayish brown to greenish gray, moderately hard, fractured and weathered	[Symbol]							
694	37	Bedding at 37 Feet: N74E; 85NW hard, slightly fractured	[Symbol]							
693	38	Jointing at 37½ Feet: N20W; 53NE Bedding at 38 Feet: N76E; 88NW	[Symbol]							
692	39		[Symbol]							
691	40		[Symbol]							

Surface: Level

Drill Method: Bucket Auger

Drill Date: 12/28/98

Size: 24 Inch

Elevation: 731

Sheet: 2 of 3

Project No: JB 17973-B

Log of Boring 6

Client: HARVARD-WESTLAKE

The J. Byer Group, Inc.
512 East Wilson Ave., Suite 201
Glendale, CA 91206
(818) 549-9959

Location: West Campus

By: JET

SUBSURFACE PROFILE

Elevation	Depth	Description	Symbol	USCS	Type	Blow Count Per Foot	Moisture Content (%)	Dry Density (pcf)	% Saturation	Remarks
690	41	Bedding at 40 Feet: N74E; 87NW	xxxxxx xxxxxx xxxxxx xxxxxx xxxxxx xxxxxx xxxxxx							
689	42		xxxxxx xxxxxx xxxxxx							
688	43	End at 43 Feet; No Water; No Caving; Fill to 3 Feet	xxxxxx xxxxxx xxxxxx							
687	44									
686	45									
685	46									
684	47									
683	48									
682	49									
681	50									
680	51									
679	52									
678	53									
677	54									
676	55									
675	56									
674	57									
673	58									
672	59									
671	60									

Surface: Level

Drill Method: Bucket Auger

Drill Date: 12/28/98

Size: 24 Inch

Elevation: 731

Sheet: 3 of 3

May 18, 2015
BG 21898

APPENDIX IV

Byer Geotechnical, Inc. (BG 21401), excerpts from report dated September 20, 2011



BYER GEOTECHNICAL, INC.

1461 E. CHEVY CHASE DR., SUITE 200
 GLENDALE, CA 91206
 818.549.9959 TEL
 818.543.3747 FAX

LOG OF BORING B1

BG No. 21401

PAGE 1 OF 2

CLIENT DWR Construction, Inc. REPORT DATE 9/20/11

DRILL DATE 8/22/11

PROJECT LOCATION 3700 Coldwater Canyon Avenue, Studio City

LOGGED BY JET

CONTRACTOR Choice Drilling DRILLING METHOD Hollow-Stem Auger

HOLE SIZE 8-inch diameter

DRIVE WEIGHT 140-Pound Automatic Hammer **HAMMER DROP** 30 inches

ELEV. TOP OF HOLE 688 ft

ELEVATION (ft)	DEPTH (ft)	EARTH MATERIAL DESCRIPTION	GRAPHIC SYMBOL	USCS UNIT	SAMPLE TYPE & NUMBER	BLOW COUNT (Per 6 inches)	MOISTURE CONTENT (%)	DRY UNIT WT. (pcf)	SATURATION (%)	TYPE OF TEST
0	0	Surface: Level Dirt								
	0-3'	(ML) FILL: Clayey Silt, black, dark gray-brown, moist, firm, some rock and concrete fragments up to 4 inches		ML						
685	3-6'	(ML) ALLUVIUM: Clayey Silt, dark brown, moist, firm		ML		8 10 10	14.9	99.4		
	6-8'					6 7 8				
680	8-10'					12 14 20	19.8	105.6		Direct Shear, Consolidation
	10-10.5'	(SW-SM) 10.5': Sandy Silt, brown, moist, firm, some clay and gravel		SW-SM		7 8 9				
675	10.5-14'	(CL) 14': Gravelly Clay, brown, tan, dark gray, moist, firm		CL		13 18 20	97.2	104.3		Consolidation
	14-17'	(CL) 17': Gravelly Clay, brown, tan, gray, moist, very dense		CL		8 11 14				
670	17-20'					11 13 15				
20	20									

BORING LOG BYER BY RSE - GINT STD US BYER.GDT - 9/20/11 09:53 - P121000 - P121000 - 21999(21401) DWR-HARVARD WESTLAKE/GINT BORING LOG.GPJ

 Ring Sample
  Standard Penetration Test



BYER GEOTECHNICAL, INC.

1461 E. CHEVY CHASE DR., SUITE 200
 GLENDALE, CA 91206
 818.549.9959 TEL
 818.543.3747 FAX

LOG OF BORING B1

BG No. 21401

PAGE 2 OF 2

CLIENT DWR Construction, Inc. REPORT DATE 9/20/11 DRILL DATE 8/22/11
 PROJECT LOCATION 3700 Coldwater Canyon Avenue, Studio City LOGGED BY JET
 CONTRACTOR Choice Drilling DRILLING METHOD Hollow-Stem Auger HOLE SIZE 8-inch diameter
 DRIVE WEIGHT 140-Pound Automatic Hammer HAMMER DROP 30 Inches ELEV. TOP OF HOLE 688 ft

ELEVATION (ft)	DEPTH (ft)	EARTH MATERIAL DESCRIPTION	GRAPHIC SYMBOL	USCS UNIT	SAMPLE TYPE & NUMBER	BLOW COUNT (Per 6 inches)	MOISTURE CONTENT (%)	DRY UNIT WT. (pcf)	SATURATION (%)	TYPE OF TEST
688	20	(CL) 20': Sandy Clay, light brown, very moist, dense, some gravel		CL		18 24 24				Consolidation
665	25	(CL) 24.5': Sandy Clay, more gravel, wet		CL		9 11 14				
660	30	BEDROCK: 27': Diatomaceous Siltstone and Shale, gray, light gray, soft to moderately hard, contorted, no structure				12 16 18				
655	35	33': gray, moderately hard				12 16 18	62.3	60.5		Direct Shear
		50				50				

End at 35.5 Feet; No Caving ; Groundwater at 29 Feet;
 Fill to 3 Feet

BORING LOG BYER BY RSB - GINT STD. US BYER.GDT - 9/20/11 09:53 - P:\21000 - 21999\21401 DWR-HARVARD WESTLAKE.GINT BORING LOG.GPJ

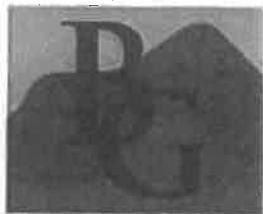

BYER GEOTECHNICAL, INC.

1461 E. CHEVY CHASE DR., SUITE 200
 GLENDALE, CA 91206
 818.549.9959 TEL
 818.543.3747 FAX

LOG OF BORING B2

BG No. 21401

PAGE 1 OF 2

CLIENT DWR Construction, Inc.

REPORT DATE 9/20/11

DRILL DATE 8/22/11

PROJECT LOCATION 3700 Coldwater Canyon Avenue, Studio City

LOGGED BY JET

CONTRACTOR Choice Drilling

DRILLING METHOD Hollow-Stem Auger

HOLE SIZE 8-inch diameter

DRIVE WEIGHT 140-Pound Automatic Hammer HAMMER DROP 30 Inches

ELEV. TOP OF HOLE 682 ft

ELEVATION (ft)	DEPTH (ft)	EARTH MATERIAL DESCRIPTION	GRAPHIC SYMBOL	USCS UNIT	SAMPLE TYPE & NUMBER	BLOW COUNT (Per 6 inches)	MOISTURE CONTENT (%)	DRY UNIT WT. (pcf)	SATURATION (%)	TYPE OF TEST
0	0	Surface: Level Dirt		ML						
680	0-2'	(ML) FILL: Clayey Silt, black, dark gray-brown, moist, firm, some gravel		ML						
	2'	(ML) ALLUVIUM: Clayey Silt, dark brown, moist, firm		ML		10 11 12	23.1	98		Consolidation
	4'	(CL) 4': Gravelly Clay, tan, light brown, moist, dense		CL		12 14 18	15.6	100.6		
675						10 12 14				
670	11'	(CL-ML) 11': Silty Clay, dark gray, moist, firm		CL-ML		10 12 16				
	14'	(CL-ML) 14': Silty Clay, brown, light gray		CL-ML		10 13 15				
665						9 12 15				
20						9 14 15				

BORING LOG BYER BY RSB - CINT STD US BYER.GDT - 9/20/11 09:53 - P:\21000 - 2138921401 DWR-HARVARD WESTLAKE\GINT BORING LOG.GPJ

Ring Sample

Standard Penetration Test



BYER GEOTECHNICAL, INC.

1461 E. CHEVY CHASE DR., SUITE 200
 GLENDALE, CA 91206
 818.549.9959 TEL
 818.543.3747 FAX

LOG OF BORING B2

BG No. 21401

PAGE 2 OF 2

CLIENT DWR Construction, Inc. REPORT DATE 9/20/11 DRILL DATE 8/22/11
 PROJECT LOCATION 3700 Coldwater Canyon Avenue, Studio City LOGGED BY JET
 CONTRACTOR Choice Drilling DRILLING METHOD Hollow-Stem Auger HOLE SIZE 8-inch diameter
 DRIVE WEIGHT 140-Pound Automatic Hammer HAMMER DROP 30 Inches ELEV. TOP OF HOLE 682 ft

ELEVATION (ft)	DEPTH (ft)	EARTH MATERIAL DESCRIPTION	GRAPHIC SYMBOL	USCS UNIT	SAMPLE TYPE & NUMBER	BLOW COUNT (Per 6 inches)	MOISTURE CONTENT (%)	DRY UNIT WT. (pcf)	SATURATION (%)	TYPE OF TEST
682	20	(SW-SM) 20': Sandy Silt, tan, light gray, moist, dense, some clay		SW-SM		10 14 20				
660		(ML) 22.5': Clayey Silt, brown, gray, moist, firm		ML		8 12 15				
25		BEDROCK: 25': Diatomaceous Siltstone and Shale, gray, light gray, soft to moderately hard				11 18 18				
655						12 18 15				
30		30.5': gray, dark, gray, moderately hard				25 25 35	39.8	78.7		
650										
35										

End at 35 Feet; No Water; No Caving; Fill to 2 Feet

BORING LOG BYER BY RSB - CINT STD US BYER.GDT - 9/20/11 09:53 - P:\21000 - 21999\21401 DWR-HARVARD WESTLAKE\GINT BORING LOG.GPJ

May 18, 2015
BG 21898

APPENDIX V

Grover Hollingsworth and Associates, Inc., report dated March 25, 2015

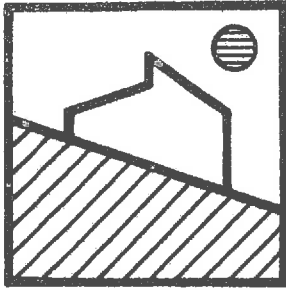

Grover Hollingsworth and Associates, Inc.

March 25, 2015
GH16870-G

Harvard-Westlake School
3700 N. Coldwater Canyon Avenue
Studio City, California 91604

Attention: David Weil

Subject: Subsurface Exploration and Laboratory Test Results, Proposed Parking Structure Retaining Walls and Pedestrian Bridge; APNs 2385-018-001, -002, -003 and -011, and 2384-007-005, 2385-019-016, -015, -014, -013, -017, -049, -050 and -015; Arbs 1 and 2, Fraction of Lot 135, Tract 6293, Arbs 1 and 2, Lot 1111, and Arb 45, Portion of Lot 1112, Tract 1000, and Arbs 1 and 2, Lot 65, and Lots 63, 64, 66, 67, 68 and 69, Tract 7442; 3675, 3693, 3703, 3709, 3707, 3717, 3719, 3705 and 3700 N. Coldwater Canyon Avenue; 12908, 12916, 12924 and 12930 W. Hacienda Drive; and 3686 and 3678 N. Potosi Avenue, Studio City, California.

Gentlemen:

The following provides the findings of our subsurface exploration and laboratory testing performed on the subject property. The exploration was performed in conjunction with the Byer Geotechnical, the geologic and geotechnical consultant of record for the project.

The exploration was conducted in areas of the proposed project, as shown on the enclosed Geologic Map. The boring and test pit locations were selected to supplement the previous exploration by Byer Geotechnical, Inc., and by Geotechnical Professionals Inc.

The field exploration was conducted between September 29 and October 7, 2014, with the aid of truck-mounted bucket-auger drill rigs, hollow-stem auger drill rig, and a hand labor.

Exploration included drilling eight (8) borings and excavating three (3) test pits to depths of 6½ to 76 feet. Samples were obtained from the test pits and borings and taken to our

Engineering Geology

Geotechnical Engineering

31129 Via Colinas, Suite 707, Westlake Village, California 91362 • (818) 889-0844 • (FAX) 889-4170

laboratory. Samples were also collected by Byer Geotechnical. Downhole observation of the earth materials encountered in the borings and test pits was performed by staff and project geologists. Excavation spoils and samples from the hollow-stem-auger borings were visually logged by the principal engineer. Excavations were backfilled and tamped but should not be considered compacted. Bedrock exposures adjacent to and within the property were mapped where possible.

Office tasks included laboratory testing, review of reports from previous consultants, and the preparation of this report. Borings and test pits are logged on plates A-1 through A-11c. Laboratory test methodology and results are discussed in the Appendix and are presented on plates A, B and F, and the Direct Shear Test plots. Surface geologic conditions and the locations of the test pits and borings are shown on the Geologic Map prepared by Byer Geotechnical.

Should you have any questions, please feel free to call.

Respectfully submitted,



MARTIN E. LIERANCE
Project Geologist

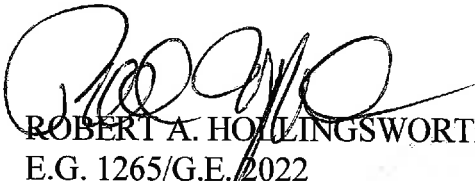

ROBERT A. HOLLINGSWORTH
E.G. 1265/G.E. 2022

MEL:RAH:dl:sh

Enc: Appendix
Plates A-1 thru A-11c
Plates B-1 thru B-15a
Plate F
Shear Strength Diagrams (46)
HDR Test Results (2)

xc: (2) Addressee (Attention: David Weil)
(4) Byer Geotechnical (Attention: Robert Zweigler)
(1) Robert Zweigler, by email
(1) David Weil, by email
(1) Edgar Khalation, by email

APPENDIX

LABORATORY TESTING

Sample Retrieval - Hand Labor

Undisturbed samples of earth materials were obtained by driving a thin-walled steel sampler with successive blows of a drop hammer. The material was retained in brass rings of 2.41 inches inside diameter and 1.00 inch height. The samples were stored in close-fitting, water-tight containers for transportation to the laboratory.

Sample Retrieval - Drill Rig

Undisturbed samples of earth materials were obtained at frequent intervals by driving a thin-walled steel sampler with successive drops of the Kelly bar dropped 12 inches with a cable winch mechanism. The material was retained in brass rings of 2.41 inches inside diameter and 1.00 inch height. The central portion of the sample was stored in close-fitting, water-tight containers for transportation to the laboratory.

Atterberg Limits

Atterberg Limits tests were performed on selected samples in accordance with ASTM D4318-10. The results of Atterberg Limits tests are shown on Plate F.

Moisture Density

The field moisture content and dry density were determined for each of the undisturbed soil samples in accordance with ASTM D2216-10 and D2937-10. The dry density was determined in pounds per cubic foot. The moisture content was determined as a percentage of the dry soil weight. The results are presented on the A-plates.

Shear Strength

The peak and ultimate shear strengths of the alluvial weathered bedrock and bedrock were determined by performing direct shear tests in accordance with ASTM D3080/M-11 and D5607-08. The tests were performed in a strain-controlled machine manufactured by GeoMatic. The rate of deformation was 0.01 inches per minute. Samples were sheared under varying confining pressures, as shown on the "Shear Test Diagrams," B-plates. The residual shear strengths of the sheared bedrock, alluvium and weathered bedrock were determined by repeatedly shearing samples under varying confining pressures in the direct shear machine. The rate of deformation for the last test at each confining pressure was 0.01 inches per minute. The space between the shear rings was cleaned before the last cycle of shearing. The moisture conditions during testing are shown on the B-plates. The samples were artificially saturated in the laboratory and were sheared under submerged conditions.

LOG OF TEST PIT GHTP-1

Date Drilled: 10/2/14 Logged by: E. Wolf Project Manager: R. Hollingsworth
 Equipment: Hand Labor Driving Weight and Drop: Hand Sampler
 Surface Elevation(ft): 776.0 Depth to Water(ft): _____

DEPTH (ft)	GRAPHIC LOG	SUMMARY OF SUBSURFACE CONDITIONS	SAMPLES		BLOWS/FOOT (Equiv. SPT)	MOISTURE (%)	DRY UNIT WT. (pcf)	SAMPLE TYPE
			DRIVE	BULK				
5		FILL: Silty Clay, gray-brown, gray, dry, soft; contains roots, rootlets and scattered gravel. Contact is undular and dips approximately 37 degrees to the southeast (downslope). SOIL: Silty Clay and Sandy Silty Clay, light to medium gray, gray, brown with white to tan specs, slightly moist, firm to stiff, moderately porous; contains roots, rootlets, animal burrows and scattered sand to gravel-sized bedrock fragments.			HS	14.8	66.4	R
		Contact is undular and dips approximately 35 degrees to the southeast. WEATHERED BEDROCK: Gravelly Silty Clay and Cobbelly Silty Clay, light to medium gray, gray-brown matrix with white to off white and light gray bedrock fragments, slightly moist, stiff; contains sparse roots, rootlets and animal burrows. Contact is undular and dips approximately 25 degrees southeast. BEDROCK: Modelo Formation Siltstone and Diatomaceous Shale, off white to white, light gray, tan, light gray-brown, dry to slightly moist, moderately hard, friable, thinly bedded and laminated. Bedding: N56E, 68NW			HS	16.1	58.1	R
		END at 6-1/2' No Water; No Caving Fill to 1'						

GEO5 16870LOG.GPJ 11/13/14



Project Name: Harvard Westlake School
 Project No: 16870-G
 3701 thru 3801 N. Coldwater Canyon, Avenue Los Angeles

Plate
 A-1

LOG OF TEST PIT GHTP-2

Date Drilled: 10/2/14 Logged by: E. Wolf Project Manager: R. Hollingsworth
 Equipment: Hand Labor Driving Weight and Drop: Hand Sampler
 Surface Elevation(ft): 781.0 Depth to Water(ft): _____

DEPTH (ft)	GRAPHIC LOG	SUMMARY OF SUBSURFACE CONDITIONS	SAMPLES		BLOWS/FOOT (Equiv. SPT)	MOISTURE (%)	DRY UNIT WT. (pcf)	SAMPLE TYPE
			DRIVE	BULK				
		<p>COLLUVIUM: Silty Clay, gray-brown, gray, dry, loose; contains rootlets and sparse gravel.</p> <p>Contact is slightly gradational and dips approximately 15 degrees to the east.</p> <p>ALLUVIUM: Silty Clay, light to medium gray, gray-brown with scattered white to tan specs, dry to slightly moist, firm to stiff; contains roots, rootlets and gravel to small cobble-sized bedrock fragments.</p>						
5					HS	14.7	66.1	R
					HS	14.7	72.0	R
					HS	16.5	70.1	R
					HS	17.2	74.7	R

GEO5_168701.OG.GPI 11/13/14



**Grover
Hollingsworth
and Associates, Inc.**

Project Name: Harvard Westlake School
 3701 thru 3801 N. Coldwater Canyon, Avenue Los Angeles

Project No. 16870-G

Plate A-2a

LOG OF TEST PIT GHTP-2

Date Drilled: 10/2/14 Logged by: E. Wolf Project Manager: R. Hollingsworth
 Equipment: Hand Labor Driving Weight and Drop: Hand Sampler
 Surface Elevation(ft): 781.0 Depth to Water(ft): _____

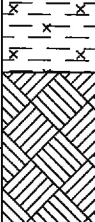
DEPTH (ft)	GRAPHIC LOG	SUMMARY OF SUBSURFACE CONDITIONS	SAMPLES		BLOWS/FOOT (Equiv. SPT)	MOISTURE (%)	DRY UNIT WT. (pcf)	SAMPLE TYPE
			DRIVE	BULK				
10		BEDROCK: Modelo Formation Siltstone and Diatomaceous Shale, off white to white, light gray, tan, slightly moist, moderately hard.			HS	26.7	53.7	R
		END at 10-1/2' No Water; No Caving No Fill						
15								

GEO5 16870LOG.GPJ 11/13/14



Project Name: Harvard Westlake School
 3701 thru 3801 N. Coldwater Canyon, Avenue Los Angeles

Project No. 16870-G

Plate
A-2b

LOG OF TEST PIT GHTP-3

Date Drilled: 10/2/14 Logged by: E. Wolf Project Manager: R. Hollingsworth

Equipment: Hand Labor Driving Weight and Drop: Hand Sampler

Surface Elevation(ft): 777.0 Depth to Water(ft): _____

DEPTH (ft)	GRAPHIC LOG	SUMMARY OF SUBSURFACE CONDITIONS	SAMPLES		BLOWS/FOOT (Equiv. SPT)	MOISTURE (%)	DRY UNIT WT. (pcf)	SAMPLE TYPE
			DRIVE	BULK				
5		<p>FILL: Silty Clay, gray-brown, light gray, dry, soft; contains rootlets and scattered gravel.</p> <p>Contact undular and dips approximately 10 degrees southwest.</p>						
		<p>ALLUVIUM: Sandy Silty Clay, gray-brown, light gray with specs of white, tan and orange-brown, dry to slightly moist, firm, slightly porous; contains roots, rootlets, animal burrows and gravel-sized bedrock fragments.</p>	■	HS	13.3	76.6	R	
		<p>END at 6-1/2' No Water; No Caving Fill to 2'</p>	■	HS	13.1	76.1	R	

GEO5_16870.LOG.GPI 11/13/14



Project Name: Harvard Westlake School
 Project No. 16870-G
 3701 thru 3801 N. Coldwater Canyon, Avenue Los Angeles

Plate
A-3

LOG OF BOREHOLE GHB-1

Date Drilled: 9/29/14

Logged by: M. Lieurance/E. Wolf Project Manager: R. Hollingsworth

Equipment: Drill Rig-Bucket Auger

Driving Weight and Drop: 10" Ring Samples

Surface Elevation(ft): _____

Depth to Water(ft): _____

DEPTH (ft)	GRAPHIC LOG	SUMMARY OF SUBSURFACE CONDITIONS	SAMPLES		BLOWS/FOOT (Equiv. SPT)	MOISTURE (%)	DRY UNIT WT. (pcf)	SAMPLE TYPE
			DRIVE	BULK				
		<p>FILL: Gravelly Sandy Clay, gray-brown, dry, soft to stiff.</p> <p>Contact dips gently to the east.</p> <p>SOIL: Sandy Silty Clay, light brown, dry to slightly moist, firm, porous.</p> <p>Note: Unoriented sample at 5' exhibits thin bedding and lamination that is apparently vertical (dip approximately 90 degrees).</p> <p>BEDROCK: Modelo Formation, Diatomaceous Shale and Siltstone, light gray, off white, light brown, orange-brown, slightly moist, moderately hard, weathered to moderately weathered, thin beds & laminae. Bedding at 6': N55E, 76NW</p> <p>Bedding at 10': N70E, 74NW</p> <p>Joints at 11': N60W, 15SW N5W, 77E</p>	<div style="background-color: black; width: 100%; height: 100%;"></div>	<div style="background-color: black; width: 100%; height: 100%;"></div>	<p>3/10"</p> <p>3/10"</p>	<p>36.4</p>	<p>66.7</p>	<p>R</p> <p>R</p>

GEO2_16870LOG.GPI 11/13/14



**Grover
Hollingsworth
and Associates, Inc.**

Project Name: Harvard Westlake School
3701 thru 3801 N. Coldwater Canyon, Avenue Los Angeles

Project No. 16870-G

Plate
A-4a

LOG OF BOREHOLE GHB-2

Date Drilled: 9/29/14 Logged by: M. Lieurance/E. Wolf Project Manager: R. Hollingsworth
 Equipment: Drill Rig-Bucket Auger Driving Weight and Drop: 10" Ring Samples
 Surface Elevation(ft): _____ Depth to Water(ft): _____

DEPTH (ft)	GRAPHIC LOG	SUMMARY OF SUBSURFACE CONDITIONS	SAMPLES		BLOWS/FOOT (Equiv. SPT)	MOISTURE (%)	DRY UNIT WT. (pcf)	SAMPLE TYPE
			DRIVE	BULK				
		<p>FILL: Gravelly Sandy Clay, light gray brown and white, dry to slightly moist, soft to slightly firm. Contact approximately horizontal</p> <p>Sandy Silty Clay, brown, slightly moist to moist, firm.</p>						
5		<p>Contact dips gently to the east.</p> <p>SOIL: Sandy Silty Clay, brown, gray-brown, slightly moist, firm to stiff, porous; contains white stringers in some locations.</p>			1			R
10		<p>Contact gradational and indistinct.</p> <p>ALLUVIUM: Clayey Silt, light brown with white specs and stringers, slightly moist, stiff, porous; contains rootlets in some locations.</p>			2	14.7	75.4	R
		Contains sedimentary rock fragments below 14'						

GEO2_16870LOG.GPJ 11/13/14



Project Name: Harvard Westlake School
 Project No. 16870-G
 3701 thru 3801 N. Coldwater Canyon, Avenue Los Angeles

Plate
 A-5a

LOG OF BOREHOLE GHB-2

Date Drilled: 9/29/14

Logged by: M. Lieurance/E. Wolf Project Manager: R. Hollingsworth

Equipment: Drill Rig-Bucket Auger

Driving Weight and Drop: 10" Ring Samples

Surface Elevation(ft): _____

Depth to Water(ft): _____

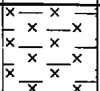
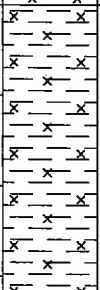
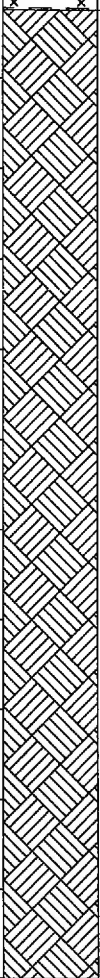
DEPTH (ft)	GRAPHIC LOG	SUMMARY OF SUBSURFACE CONDITIONS	SAMPLES		BLOWS/FOOT (Equiv. SPT)	MOISTURE (%)	DRY UNIT WT. (pcf)	SAMPLE TYPE
			DRIVE	BULK				
		Color changes to light green-gray with white specks			2			R
		Sandy Silty Clay, gray-brown, moist, stiff to very stiff; contains numerous white stringers.						
20		Top of bedrock contact is irregular with overall dip gently to the north. BEDROCK: Diatomaceous Shale and Siltstone, white, light brown and light tan, slightly moist, moderately hard to hard, moderately weathered, laminated to thinly bedded, slightly fractured to unfractured, tight. Bedding at 20', N55E, 64NW.			7	44.8	50.4	R
		Joint: N70W, 57SW						
25		Bedding: N65E, 65NW			8			R

GEO2 16870LOG.GPJ 11/13/14



Project Name: Harvard Westlake School
3701 thru 3801 N. Coldwater Canyon, Avenue Los Angeles

Project No. 16870-G

Plate A-5b

LOG OF BOREHOLE GHB-2

Date Drilled: 9/29/14 Logged by: M. Lieurance/E. Wolf Project Manager: R. Hollingsworth
 Equipment: Drill Rig-Bucket Auger Driving Weight and Drop: 10" Ring Samples
 Surface Elevation(ft): _____ Depth to Water(ft): _____

DEPTH (ft)	GRAPHIC LOG	SUMMARY OF SUBSURFACE CONDITIONS	SAMPLES		BLOWS/FOOT (Equiv. SPT)	MOISTURE (%)	DRY UNIT WT. (pcf)	SAMPLE TYPE
			DRIVE	BULK				
		Bedding: N60E, 63NW			13	62.3	45.0	R
		Jointing: N65W, 70NE						
35		Tailings color changes to light green-gray			5	61.5	54.8	R
		Bedding: N60E, 64NW						
		Joint: N30W, 59NE						
40		Bedding: N65E, 62NW			6			R
		Joint: N5W, 63NE						

GEO2_16870L.0G.GPJ 11/13/14



**Grover
Hollingsworth
and Associates, Inc.**

Project Name: Harvard Westlake School
 Project No. 16870-G
 3701 thru 3801 N. Coldwater Canyon, Avenue Los Angeles

Plate
A-5c

LOG OF BOREHOLE GHB-2

Date Drilled: 9/29/14 Logged by: M. Lieurance/E. Wolf Project Manager: R. Hollingsworth
 Equipment: Drill Rig-Bucket Auger Driving Weight and Drop: 10" Ring Samples
 Surface Elevation(ft): _____ Depth to Water(ft): _____

DEPTH (ft)	GRAPHIC LOG	SUMMARY OF SUBSURFACE CONDITIONS	SAMPLES		BLOWS/FOOT (Equiv. SPT)	MOISTURE (%)	DRY UNIT WT. (pcf)	SAMPLE TYPE
			DRIVE	BULK				
		Bedding: N65E, 62NW			8			R
50		Bedding: N65E, 66NW			12	79.7	48.9	R
55		Bedding: N70E, 63NW			6			R
		Siltstone, light brown, tan, gray-brown, off-white, medium brown, orange-brown, slightly moist, moderately hard, moderately weathered, slightly fractured, thinly bedded and laminated, moderately cemented.						

GEO2_16870LOG.GPJ 11/13/14



**Grover
Hollingsworth
and Associates, Inc.**

Project Name: Harvard Westlake School
 Project No: 16870-G
 3701 thru 3801 N. Coldwater Canyon, Avenue Los Angeles

Plate
A-5d

LOG OF BOREHOLE GHB-2

Date Drilled: 9/29/14 Logged by: M. Lieurance/E. Wolf Project Manager: R. Hollingsworth
 Equipment: Drill Rig-Bucket Auger Driving Weight and Drop: 10" Ring Samples
 Surface Elevation(ft): _____ Depth to Water(ft): _____

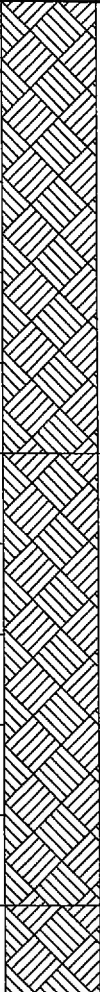
DEPTH (ft)	GRAPHIC LOG	SUMMARY OF SUBSURFACE CONDITIONS	SAMPLES		BLOWS/FOOT (Equiv. SPT)	MOISTURE (%)	DRY UNIT WT. (pcf)	SAMPLE TYPE	
			DRIVE	BULK					
		Bedding: N60E, 66NW			20	75.1	50.6	R	
		Shear surface offsets bedding by 1", N10W, 53E							
65		Bedding: N60E, 67NW			31				R
		Siltstone, dark gray, green-gray, gray-brown, moist, moderately hard to hard, laminated with bedding less distinct than above, slightly weathered, unfractured.							
		Bedding: N65E, 68NW							
70		Siltstone: light to dark gray, green-gray, moderately moist, hard, unweathered, unfractured.			33	30.1	74.3	R	
		END at 71' No Water, No Caving Fill to 4'							

GEO2. 16870LOG.GPT 11/13/14



**Grover
Hollingsworth
and Associates, Inc.**

Project Name: Harvard Westlake School
 3701 thru 3801 N. Coldwater Canyon, Avenue Los Angeles

Project No.
16870-G

Plate
A-5e

LOG OF BOREHOLE GHB-3

Date Drilled: 9/30/14

Logged by: M. Lieurance/E. Wolf Project Manager: R. Hollingsworth

Equipment: Drill Rig-Bucket Auger

Driving Weight and Drop: 10" Ring Samples

Surface Elevation(ft): _____

Depth to Water(ft): _____

DEPTH (ft)	GRAPHIC LOG	SUMMARY OF SUBSURFACE CONDITIONS	SAMPLES		BLOWS/FOOT (Equiv. SPT)	MOISTURE (%)	DRY UNIT WT. (pcf)	SAMPLE TYPE
			DRIVE	BULK				
5		<p>FILL: Sandy Clayey Silt, gray, light gray, gray-brown, dry, loose to slightly dense; contains cobble-sized rock fragments and concrete debris.</p> <p>Note: Encountered several very hard cobbles in the upper 5' (concrete).</p>						
		<p>Re-bar uncovered at a depth of 8' below existing grade. Contact approximately horizontal.</p>						
		<p>SOIL: Silty Clay, brown, moist, stiff.</p>						
10		<p>Contact dips moderately north.</p> <p>WEATHERED BEDROCK: Siltstone, light gray, gray-brown, off-white, slightly moist, soft to slightly hard, bedding is poorly defined; contains rootlets and caliche stringers. Remnant Bedding at 11': E-W, 49SE</p>			2/10"	16.6	76.2	R
		<p>Remnant Bedding at 13': N65E, 56S Contact gradational.</p> <p>BEDROCK: Modelo Formation, Siltstone, gray-brown, green-gray, light to medium brown, slightly moist, moderately hard, weathered, fractured.</p>						

GEO2_16870LOG.GPJ 11/13/14



**Grover
Hollingsworth
and Associates, Inc.**

Project Name: Harvard Westlake School
 Project No: 16870-G
 3701 thru 3801 N. Coldwater Canyon, Avenue Los Angeles

Plate
A-6a

LOG OF BOREHOLE GHB-3

Date Drilled: 9/30/14

Logged by: M. Lieurance/E. Wolf Project Manager: R. Hollingsworth

Equipment: Drill Rig-Bucket Auger

Driving Weight and Drop: 10" Ring Samples

Surface Elevation(ft): _____

Depth to Water(ft): _____

DEPTH (ft)	GRAPHIC LOG	SUMMARY OF SUBSURFACE CONDITIONS	SAMPLES		BLOWS/FOOT (Equiv. SPT)	MOISTURE (%)	DRY UNIT WT. (pcf)	SAMPLE TYPE
			DRIVE	BULK				
	Sandstone, light brown, tan, gray-brown, orange-brown, moderately moist, moderately hard, moderately weathered, slightly fractured. Bedding at 45-1/2': N80E, 87S			1			R
50	xxxxxx	Sandy Siltstone, medium brown, dark gray, gray-brown, moderately moist, moderately hard, slightly fractured, slightly weathered, thinly bedded and laminated.						
55	xxxxxx	Sandy Siltstone, dark gray, green-gray, gray-brown, slightly to moderately moist, hard, slightly weathered to unweathered, lower 5' of boring infilled from caving debris at time of down hole logging, thinly bedded and laminated.			10	60.5	57.5	R
	xxxxxx	END at 56' No Water; Caving from 0' to 7' Fill to 8'						R

GEO2 168701.0G.GPJ 11/13/14



Project Name: Harvard Westlake School
 Project No: 16870-G
 3701 thru 3801 N. Coldwater Canyon, Avenue Los Angeles

Plate
A-6d

LOG OF BOREHOLE GHB-4

Date Drilled: 9/30/14 Logged by: M. Lieurance/E. Wolf Project Manager: R. Hollingsworth
 Equipment: Drill Rig-Bucket Auger Driving Weight and Drop: 10" Ring Samples
 Surface Elevation(ft): _____ Depth to Water(ft): _____

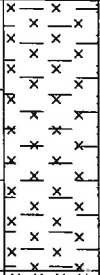
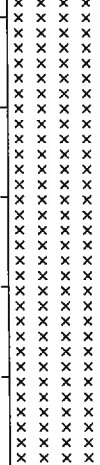
DEPTH (ft)	GRAPHIC LOG	SUMMARY OF SUBSURFACE CONDITIONS	SAMPLES		BLOWS/FOOT (Equiv. SPT)	MOISTURE (%)	DRY UNIT WT. (pcf)	SAMPLE TYPE
			DRIVE	BULK				
5		<p>FILL: Gravelly Clayey Silt, white, dry, firm to slightly stiff.</p> <p>Contact benched.</p> <p>BEDROCK: Diatomaceous Shale and Siltstone, light green-gray, slightly moist to moist, moderately hard, moderately weathered, laminated to thinly bedded; contains occasional thin sandstone beds. Bedding at 3-1/2': N45E, 73NW</p>			2	31.0	72.4	R
10					3			R

GEO2 168701.0G.GPJ 11/13/14



**Grover
Hollingsworth
and Associates, Inc.**

Project Name: Harvard Westlake School
 3701 thru 3801 N. Coldwater Canyon, Avenue Los Angeles

Project No. 16870-G

Plate
A-7a

LOG OF BOREHOLE GHB-4

Date Drilled: 9/30/14 Logged by: M. Lieurance/E. Wolf Project Manager: R. Hollingsworth
 Equipment: Drill Rig-Bucket Auger Driving Weight and Drop: 10" Ring Samples
 Surface Elevation(ft): _____ Depth to Water(ft): _____

DEPTH (ft)	GRAPHIC LOG	SUMMARY OF SUBSURFACE CONDITIONS	SAMPLES		BLOWS/FOOT (Equiv. SPT)	MOISTURE (%)	DRY UNIT WT. (pcf)	SAMPLE TYPE
			DRIVE	BULK				
	XXXXXXXXXX XXXXXXXXXX XXXXXXXXXX XXXXXXXXXX XXXXXXXXXX				28	39.1	69.0	R
80		END at 76' No Water; No Caving Fill to 3'						
85								

GEO2_168701.LOG.GPJ 11/13/14



Project Name: Harvard Westlake School
 Project No: 16870-G
 3701 thru 3801 N. Coldwater Canyon, Avenue Los Angeles

Plate
A-7f

LOG OF BOREHOLE GHB-5

Date Drilled: 10/1/14 Logged by: M. Lieurance/E. Wolf Project Manager: R. Hollingsworth
 Equipment: Drill Rig-Bucket Auger Driving Weight and Drop: 10" Ring Samples
 Surface Elevation(ft): _____ Depth to Water(ft): _____

DEPTH (ft)	GRAPHIC LOG	SUMMARY OF SUBSURFACE CONDITIONS	SAMPLES		BLOWS/FOOT (Equiv. SPT)	MOISTURE (%)	DRY UNIT WT. (pcf)	SAMPLE TYPE
			DRIVE	BULK				
5		<p>FILL: Sandy Silty Clay, dark brown, black, dry, slightly moist, stiff; contains rootlets and full depth desiccation cracks up to 1" wide.</p> <p>Contact approximately horizontal.</p> <p>Gravelly Sandy Clay, gray, gray-brown with white specs, dry to slightly moist, firm to stiff.</p> <p>Contact dips gently east.</p> <p>Gravelly Silty Clay, white, light brown, slightly moist, very firm; contains diatomaceous rock fragments.</p> <p>Contact approximately horizontal.</p> <p>SOIL: Sandy Silty Clay, medium to dark brown with white and tan specs, slightly moist, firm, porous to highly porous.</p>			Push			R
10		<p>Contact gradational.</p> <p>ALLUVIUM: Sandy Silty Clay with minor gravel, dark brown, medium brown, gray-brown, light brown with white and tan specks, slightly moist, very firm, slightly porous; contains abundant sedimentary rock fragments.</p>			1	22.2	69.6	R

GEO2 168701.LOG.GPJ 11/13/14



Project Name: Harvard Westlake School
 3701 thru 3801 N. Coldwater Canyon, Avenue Los Angeles

Project No. 16870-G

Plate A-8a

LOG OF BOREHOLE GHB-5

Date Drilled: 10/1/14 Logged by: M. Lieurance/E. Wolf Project Manager: R. Hollingsworth

Equipment: Drill Rig-Bucket Auger Driving Weight and Drop: 10" Ring Samples

Surface Elevation(ft): _____ Depth to Water(ft): _____

DEPTH (ft)	GRAPHIC LOG	SUMMARY OF SUBSURFACE CONDITIONS	SAMPLES		BLOWS/FOOT (Equiv. SPT)	MOISTURE (%)	DRY UNIT WT. (pcf)	SAMPLE TYPE
			DRIVE	BULK				
20		<p>Very hard boulder at 16'.</p>			1			R
25		<p>Sandy Silty Clay with minor gravel, medium brown, gray-brown with white/off white specs and stringers, slightly moist, firm/stiff, slightly porous.</p>			Push	29.7	75.0	R
30		<p>More porous below 25'.</p>			Push			R

GEO2_16870LOG.GPJ 11/13/14



Project Name:
Harvard Westlake School
3701 thru 3801 N. Coldwater Canyon, Avenue Los Angeles
Project No.
16870-G
Plate
A-8b

LOG OF BOREHOLE GHB-5

Date Drilled: 10/1/14 Logged by: M. Lieurance/E. Wolf Project Manager: R. Hollingsworth

Equipment: Drill Rig-Bucket Auger Driving Weight and Drop: 10" Ring Samples

Surface Elevation(ft): _____ Depth to Water(ft): _____

DEPTH (ft)	GRAPHIC LOG	SUMMARY OF SUBSURFACE CONDITIONS	SAMPLES		BLOWS/FOOT (Equiv. SPT)	MOISTURE (%)	DRY UNIT WT. (pcf)	SAMPLE TYPE
			DRIVE	BULK				
			████		2	33.0	80.5	R
		WEATHERED BEDROCK: Clayey Silt, orange-brown, light brown to medium brown, yellow-brown, gray-brown, white, moderately moist, firm to stiff, remnant bedding is poorly to moderately undefined; contains caliche veins.						
35		BEDROCK: Modelo Formation, Shale, Mudstone, Siltstone, brown, orange-brown, tan, moist, moderately hard, moderately weathered, laminated to thinly bedded in most locations, fractured. Bedding at 35': N50E, 80NW Joint at 36': N65W, 41SW Shear plane at 37' N40W, 66NE truncated by second shear plane toward north N65E, vertical; contains striations with striations plunging gently toward east; contains gypsum veins below 37-1/2', some veins exhibit voids up to 1/8" wide. Medium brown at approximately 38', remnant bedding moderately defined. Bedding at 38': N70E, 86N	████		4			R
40		Siltstone, medium-brown, light brown, gray-brown, green-gray, orange-brown, minor red-brown, moderately moist, moderately hard, moderately weathered, thin beds and laminae, highly fractured and easily excavated.	████		3	38.1	80.0	R
		Red-brown Shale/Mudstone. Abundant gypsum in veins. Bedding at 42': N40E, 74NW Bedding at 44': N45E, 83NW Gypsum vein at 44-1/2': N55W, 18NE						

GEO2 16870.LOG.GPJ 11/13/14



Project Name: Harvard Westlake School
3701 thru 3801 N. Coldwater Canyon, Avenue Los Angeles

Project No. 16870-G

Plate
A-8c

LOG OF BOREHOLE GHB-5

Date Drilled: 10/1/14 Logged by: M. Lieurance/E. Wolf Project Manager: R. Hollingsworth

Equipment: Drill Rig-Bucket Auger Driving Weight and Drop: 10" Ring Samples

Surface Elevation(ft): _____ Depth to Water(ft): _____

DEPTH (ft)	GRAPHIC LOG	SUMMARY OF SUBSURFACE CONDITIONS	SAMPLES		BLOWS/FOOT (Equiv. SPT)	MOISTURE (%)	DRY UNIT WT. (pcf)	SAMPLE TYPE
			DRIVE	BULK				
65	xxxxxx xxxxxx xxxxxx xxxxxx	END at 61' No Water; No Caving Fill to 4'			15	30.8	85.7	R
70								

GEO2_168701.LOG.GPJ 11/13/14



**Grover
Hollingsworth
and Associates, Inc.**

Project Name: Harvard Westlake School
 Project No: 16870-G
 3701 thru 3801 N. Coldwater Canyon, Avenue Los Angeles

Plate
A-8e

LOG OF BOREHOLE GHB-6

Date Drilled: 10/1/14

Logged by: M. Lieurance/E. Wolf Project Manager: R. Hollingsworth

Equipment: Drill Rig-Bucket Auger

Driving Weight and Drop: 10" Ring Samples

Surface Elevation(ft): _____

Depth to Water(ft): _____

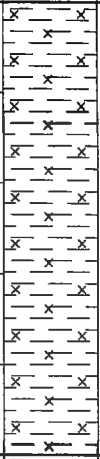
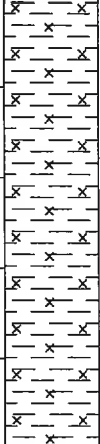
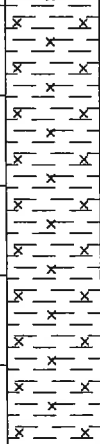
DEPTH (ft)	GRAPHIC LOG	SUMMARY OF SUBSURFACE CONDITIONS	SAMPLES		BLOWS/FOOT (Equiv. SPT)	MOISTURE (%)	DRY UNIT WT. (pcf)	SAMPLE TYPE
			DRIVE	BULK				
5		FILL: Silty Clay, gray-brown, medium brown, gray with white specs, dry to slightly moist, soft to very firm; contains rootlets, sparse roots, gravel and some cobbles, generally increasing in abundance with increasing depth.						
5		ALLUVIUM: Silty Clay, gray-brown, dry to slightly moist, stiff; contains rootlets, sparse roots, gravel and cobbles.			1	14.9	62.7	R
10					Push			R

GEO2 16870L.0G.GPI 11/13/14



**Grover
Hollingsworth
and Associates, Inc.**

Project Name: Harvard Westlake School
 Project No. 16870-G
 3701 thru 3801 N. Coldwater Canyon, Avenue Los Angeles

Plate
A-9a

LOG OF BOREHOLE GHB-6

Date Drilled: 10/1/14

Logged by: M. Lieurance/E. Wolf Project Manager: R. Hollingsworth

Equipment: Drill Rig-Bucket Auger

Driving Weight and Drop: 10" Ring Samples

Surface Elevation(ft): _____

Depth to Water(ft): _____

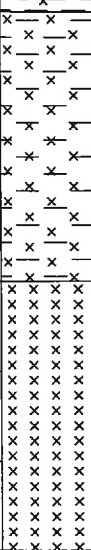
DEPTH (ft)	GRAPHIC LOG	SUMMARY OF SUBSURFACE CONDITIONS	SAMPLES		BLOWS/FOOT (Equiv. SPT)	MOISTURE (%)	DRY UNIT WT. (pcf)	SAMPLE TYPE
			DRIVE	BULK				
20		<p>Silty Clay, gray-brown, medium brown with white specs, slightly moist, firm to stiff; contains rootlets.</p> <p>Contact slightly gradational and approximately horizontal.</p> <p>Silty Clay, medium brown to dark brown with minor orange-brown, tan and white, moist, stiff to very stiff; contains scattered gravel.</p>	1		1	22.0	67.9	R
25		<p>Silty Clay with minor sand, dark brown, dark gray, slightly moist to moist, stiff.</p> <p>WEATHERED BEDROCK: Clayey Silt, orange-brown, medium brown, yellow-brown, gray-brown, green-gray, moderately moist, stiff to very stiff.</p> <p>Contact dips approximately 12 degrees northwest.</p> <p>BEDROCK: Modelo Formation, Clayey Siltstone, medium brown, orange-brown, light brown, gray-brown, green-gray, moderately moist, moderately hard, thinly bedded and laminated, fractured.</p>	3		2	36.7	77.9	R

GEO2 16870LOG.GPJ 11/13/14



**Grover
Hollingsworth
and Associates, Inc.**

Project Name: Harvard Westlake School
 3701 thru 3801 N. Coldwater Canyon, Avenue Los Angeles

Project No. 16870-G

Plate A-9b

LOG OF BOREHOLE GHB-7

Date Drilled: 10/2/14 Logged by: M. Lieurance/E. Wolf Project Manager: R. Hollingsworth
 Equipment: Drill Rig-Bucket Auger Driving Weight and Drop: 10" Ring Samples
 Surface Elevation(ft): _____ Depth to Water(ft): _____

DEPTH (ft)	GRAPHIC LOG	SUMMARY OF SUBSURFACE CONDITIONS	SAMPLES		BLOWS/FOOT (Equiv. SPT)	MOISTURE (%)	DRY UNIT WT. (pcf)	SAMPLE TYPE
			DRIVE	BULK				
	x . . x	CONCRETE: No steel reinforcement found.						
	x . . x	FILL: Silty Sand, orange-brown, dry, slightly dense.						
	x . . x	COMPACTED FILL: Gravelly Sandy Clay, light gray-brown, slightly moist, stiff.						
	x . . x	Sandy Silty Clay, mottled dark brown and brown, slightly moist, stiff.						
	x . . x	Contact horizontal.						
	x . . x	SOIL: Sandy Silty Clay, brown, moist, firm, porous.						
5	x . . x				2	18.7	78.4	R
	x . . x	ALLUVIUM: Sandy Silty Clay, light brown with white specs, slightly moist to moist, stiff, slightly porous.						
10	x . . x				2			R

GEO2 168701.0G.GPJ 11/13/14



Project Name: Harvard Westlake School
 Project No. 16870-G
 3701 thru 3801 N. Coldwater Canyon, Avenue Los Angeles

Plate
A-10a

LOG OF BOREHOLE GHB-7

Date Drilled: 10/2/14

Logged by: M. Lieurance/E. Wolf Project Manager: R. Hollingsworth

Equipment: Drill Rig-Bucket Auger

Driving Weight and Drop: 10" Ring Samples

Surface Elevation(ft): _____

Depth to Water(ft): _____

DEPTH (ft)	GRAPHIC LOG	SUMMARY OF SUBSURFACE CONDITIONS	SAMPLES		BLOWS/FOOT (Equiv. SPT)	MOISTURE (%)	DRY UNIT WT. (pcf)	SAMPLE TYPE
			DRIVE	BULK				
		<p>Sandy Silty Clay, light brown to brown with tan and yellow-brown mottling, slightly moist to moist, stiff, porous.</p>			2	28.4	68.5	R
		<p>WEATHERED BEDROCK: Sedimentary rock fragments in Sandy Clayey Silt matrix, mottled light brown, tan, light green-gray, moist, stiff, slightly porous.</p>						
20		<p>BEDROCK: Diatomaceous Shale and Siltstone, light tan and white, moist, moderately hard to hard, moderately weathered, laminated to thinly bedded, fractured. Bedding at 19-1/2': N55E, 48SE</p> <p>Tight Fold axis at 21'</p> <p>Bedding at 22': N65E, 73NW</p> <p>Bedding at 24': N70E, 69NW</p>			2			R
25					2	81.7	46.1	R
		<p>Bedding at 27-1/2': N65E, 72NW</p>						

GEOZ 16870LOG.GPJ 11/13/14



Project Name: Harvard Westlake School
 Project No: 16870-G
 3701 thru 3801 N. Coldwater Canyon, Avenue Los Angeles

Plate
A-10b

LOG OF BOREHOLE GHB-7

Date Drilled: 10/2/14 Logged by: M. Lieurance/E. Wolf Project Manager: R. Hollingsworth

Equipment: Drill Rig-Bucket Auger Driving Weight and Drop: 10" Ring Samples

Surface Elevation(ft): _____ Depth to Water(ft): _____

DEPTH (ft)	GRAPHIC LOG	SUMMARY OF SUBSURFACE CONDITIONS	SAMPLES		BLOWS/FOOT (Equiv. SPT)	MOISTURE (%)	DRY UNIT WT. (pcf)	SAMPLE TYPE
			DRIVE	BULK				
35	xxxxxx xxxxxx xxxxxx xxxxxx	END at 31' No Water; No Caving Fill to 2-1/2'			2			R
40								

GEO2_16870L.OG.GPJ 11/13/14



Project Name: Harvard Westlake School
 Project No. 16870-G
 3701 thru 3801 N. Coldwater Canyon, Avenue Los Angeles

Plate
A-10c

LOG OF BOREHOLE GHB-8

Date Drilled: 10/7/14



Logged by: R. Hollingsworth Project Manager: R. Hollingsworth

Equipment: Hollow-Stem Auger

Driving Weight and Drop: 140lb Hammer, 30" drop

Surface Elevation(ft): _____

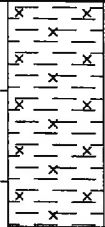
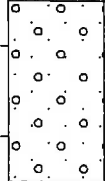
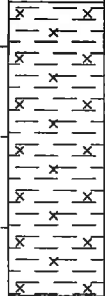
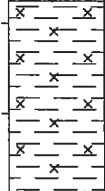
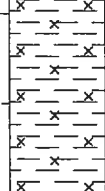
Depth to Water(ft): _____

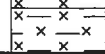
DEPTH (ft)	GRAPHIC LOG	SUMMARY OF SUBSURFACE CONDITIONS	SAMPLES		BLOWS/FOOT (Equiv. SPT)	MOISTURE (%)	DRY UNIT WT. (pcf)	SAMPLE TYPE
			DRIVE	BULK				
		FILL: Silty Clay, mottled dark brown, moist, firm, occasional gravel and cobbles to 4" diameter.						
		Clayey Sandy Gravel, dark brown and gray, moist, medium dense, mixed with silty clay, mottled dark brown, moist, firm, occasional siltstone fragments.						
5		Silty Clay, mottled medium brown to dark brown, moist, very firm.			11	29.1	85.6	R
		RESIDUAL SOIL: Silty Clay, dark brown, moist, very firm.			19	28.8	85.5	R
10					25	26.2	92.7	R
		WEATHERED BEDROCK: Clayey Silt to Silty Clay, medium brown, slightly moist, very firm.			28	26.2	93.9	R
		Slightly Clayey Silt, medium brown, slightly moist, very firm,						

GEO2 16870L.0G.GPJ 11/13/14



Project Name: Harvard Westlake School
 Project No: 16870-G
 3701 thru 3801 N. Coldwater Canyon, Avenue Los Angeles

Plate A-11a

LOG OF BOREHOLE GHB-8

Date Drilled: 10/7/14 Logged by: R. Hollingsworth Project Manager: R. Hollingsworth

Equipment: Hollow-Stem Auger Driving Weight and Drop: 140lb Hammer, 30" drop

Surface Elevation(ft): _____ Depth to Water(ft): _____

DEPTH (ft)	GRAPHIC LOG	SUMMARY OF SUBSURFACE CONDITIONS	SAMPLES		BLOWS/FOOT (Equiv. SPT)	MOISTURE (%)	DRY UNIT WT. (pcf)	SAMPLE TYPE
			DRIVE	BULK				
		slightly porous.			33	29.0	88.8	R
		Clayey Silt, medium brown and light brown, moist, firm to very firm.			22	60.6	57.3	R
20		BEDROCK: Diatomaceous Siltstone, white and light brown, slightly moist, soft to moderately hard, thinly bedded, moderate dip. Bedrock in sample tip at 18-1/2'.						
		Siltstone and Diatomaceous Siltstone, light brown and white with black staining on joints, slightly moist, moderately hard, thinly to thickly bedded, moderate to steep dip.			43	55.1	65.7	R
		Slightly Sandy Siltstone, medium brown, moist, moderately hard, thickly bedded.			41	57.3	62.8	R
25		Thickly bedded, orange-brown staining on joints.			37	49.4	69.7	R
		Bedding steeply dipping.						

GEO2 16870LOG.GPJ 11/13/14



**Grover
Hollingsworth
and Associates, Inc.**

Project Name: Harvard Westlake School
 Project No: 16870-G
 3701 thru 3801 N. Coldwater Canyon, Avenue Los Angeles

Plate
A-11b

SHEAR TEST DIAGRAM

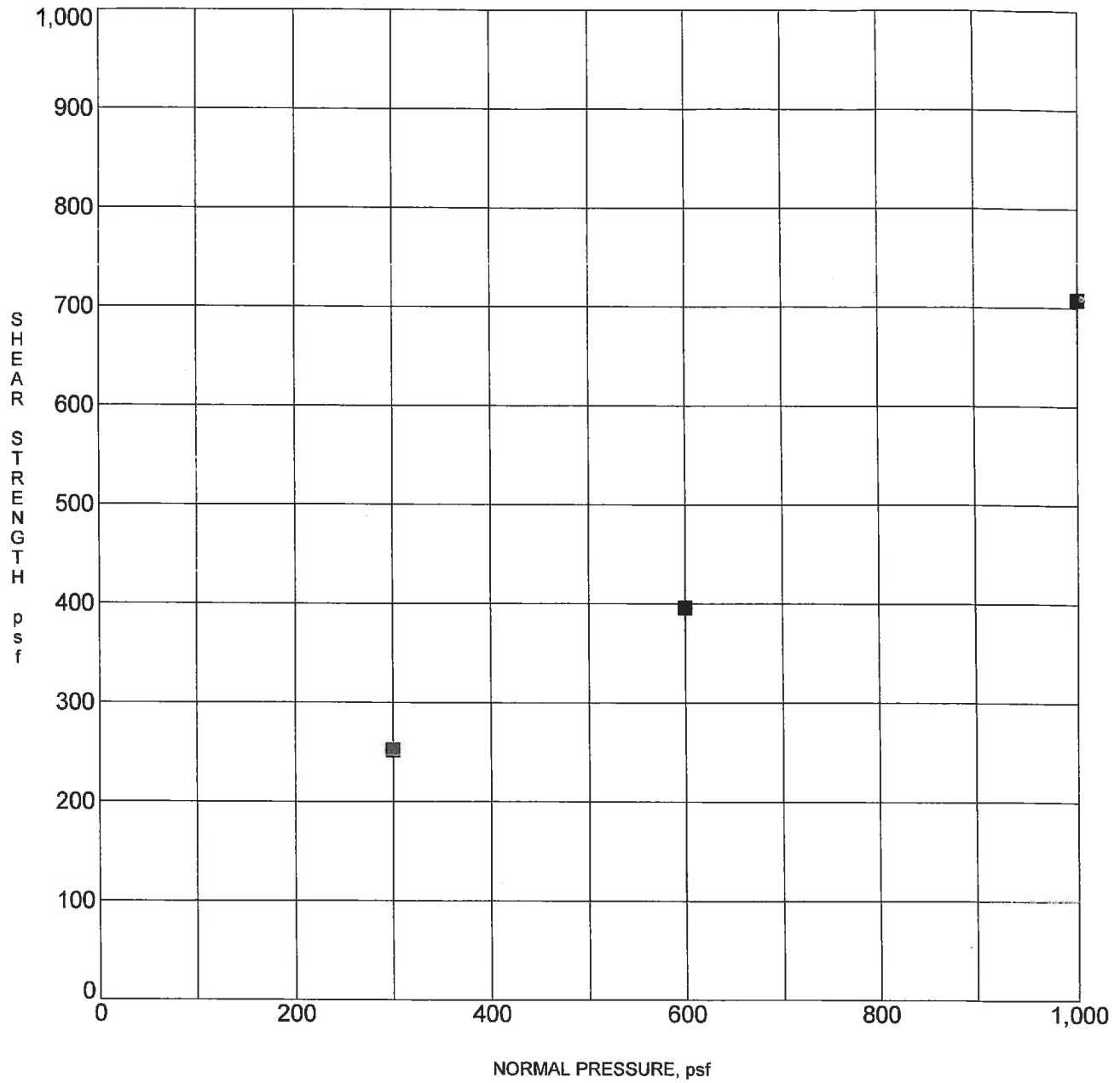

***NOTE-PEAK AND ULTIMATE STRENGTH VALUES**

Specimen Identification	Soil Type/Classification	Cohesion	Friction Angle	DD	MC%
● GHB-7	5.0 SOIL (pk)			44.5	78.4
☒ GHB-7	5.0 SOIL (ult)			44.5	78.4

PROJECT Harvard Westlake School - 3701 thru 3801 N.
Coldwater Canyon Avenue, Los Angeles

JOB NO. 16870-G
DATE 10/14

SHEAR TEST DIAGRAM

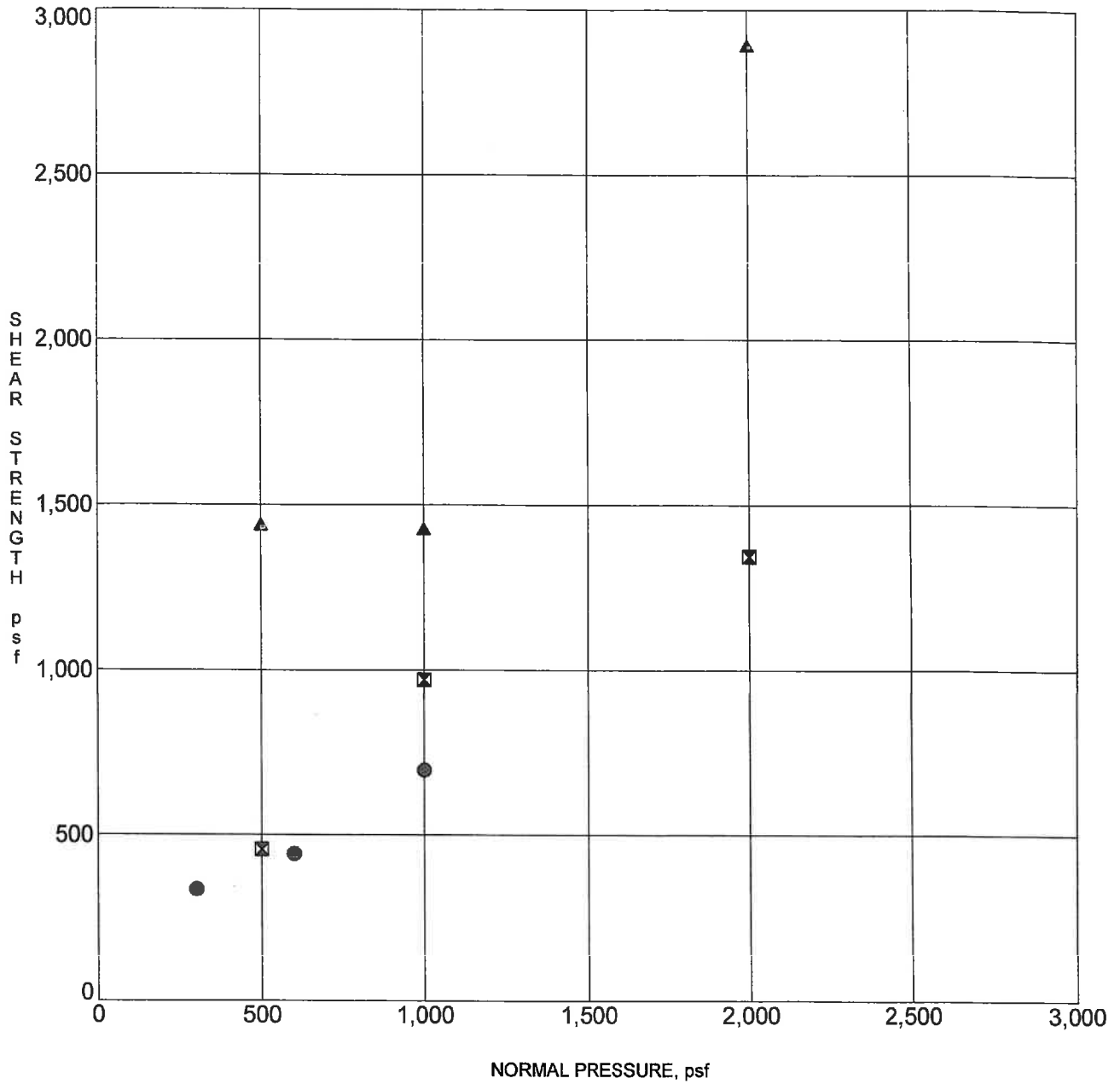

*NOTE-PEAK STRENGTH VALUES

Specimen Identification	Soil Type/Classification	Cohesion	Friction Angle	DD	MC%
● GHTP-2 4.0	ALLUVIUM			72.0	48.9
⊠ GHTP-2 6.0	ALLUVIUM			70.1	42.5
▲ GHTP-2 8.0	ALLUVIUM			74.7	53.7

PROJECT Harvard Westlake School - 3701 thru 3801 N.
Coldwater Canyon Avenue, Los Angeles

JOB NO. 16870-G
 DATE 10/14

SHEAR TEST DIAGRAM

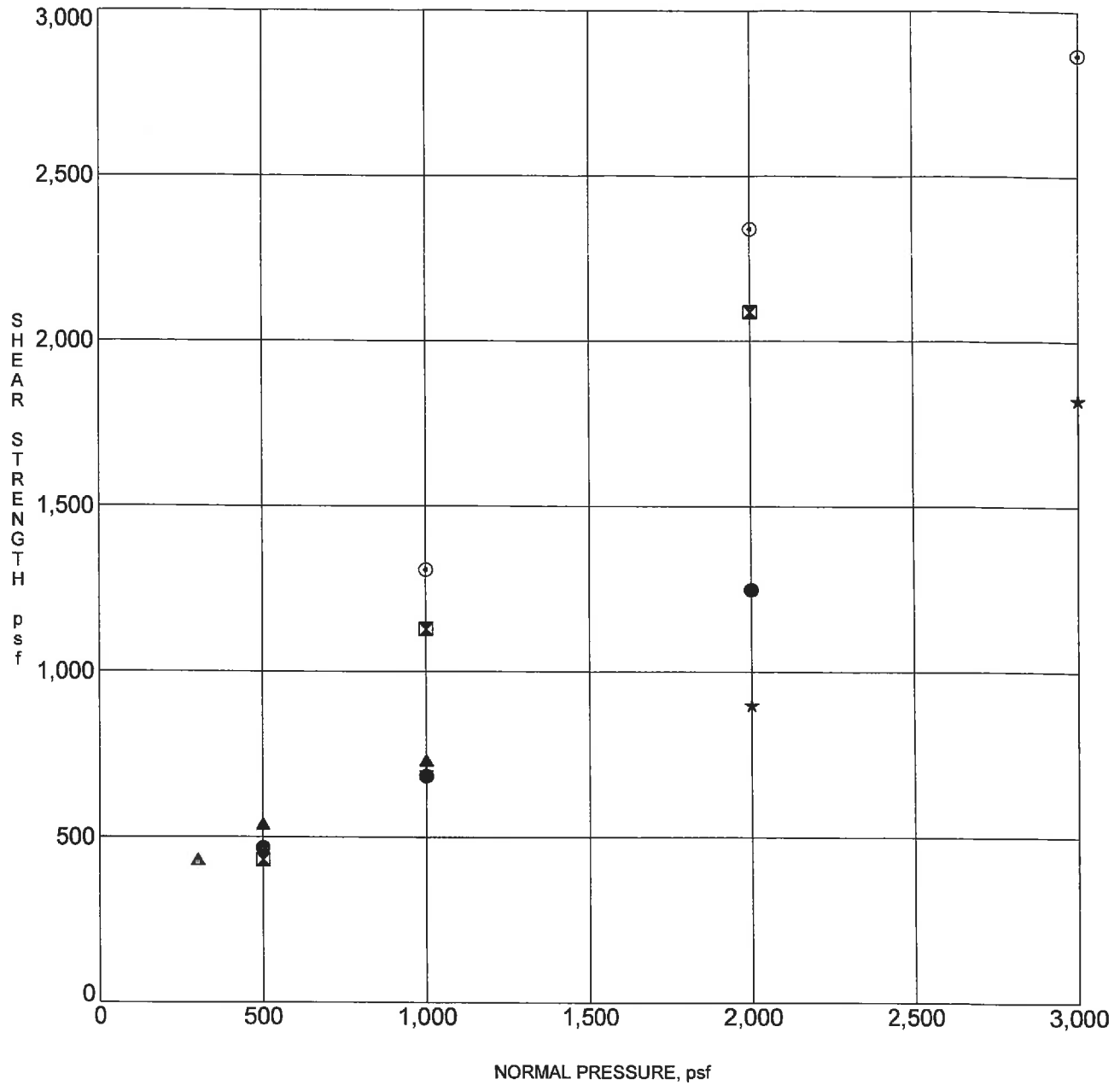

*NOTE-PEAK STRENGTH VALUES

Specimen Identification	Soil Type/Classification	Cohesion	Friction Angle	DD	MC%
● GHB-2 10.0	ALLUVIUM			75.4	40.0
⊠ GHB-5 10.0	ALLUVIUM			69.6	38.7
▲ GHB-6 5.0	ALLUVIUM			62.7	40.7
★ GHB-6 15.0	ALLUVIUM			67.9	38.9
⊙ GHB-7 15.0	ALLUVIUM			68.5	41.3

PROJECT **Harvard Westlake School - 3701 thru 3801 N.
Coldwater Canyon Avenue, Los Angeles**

JOB NO. **16870-G**
DATE **10/14**

SHEAR TEST DIAGRAM

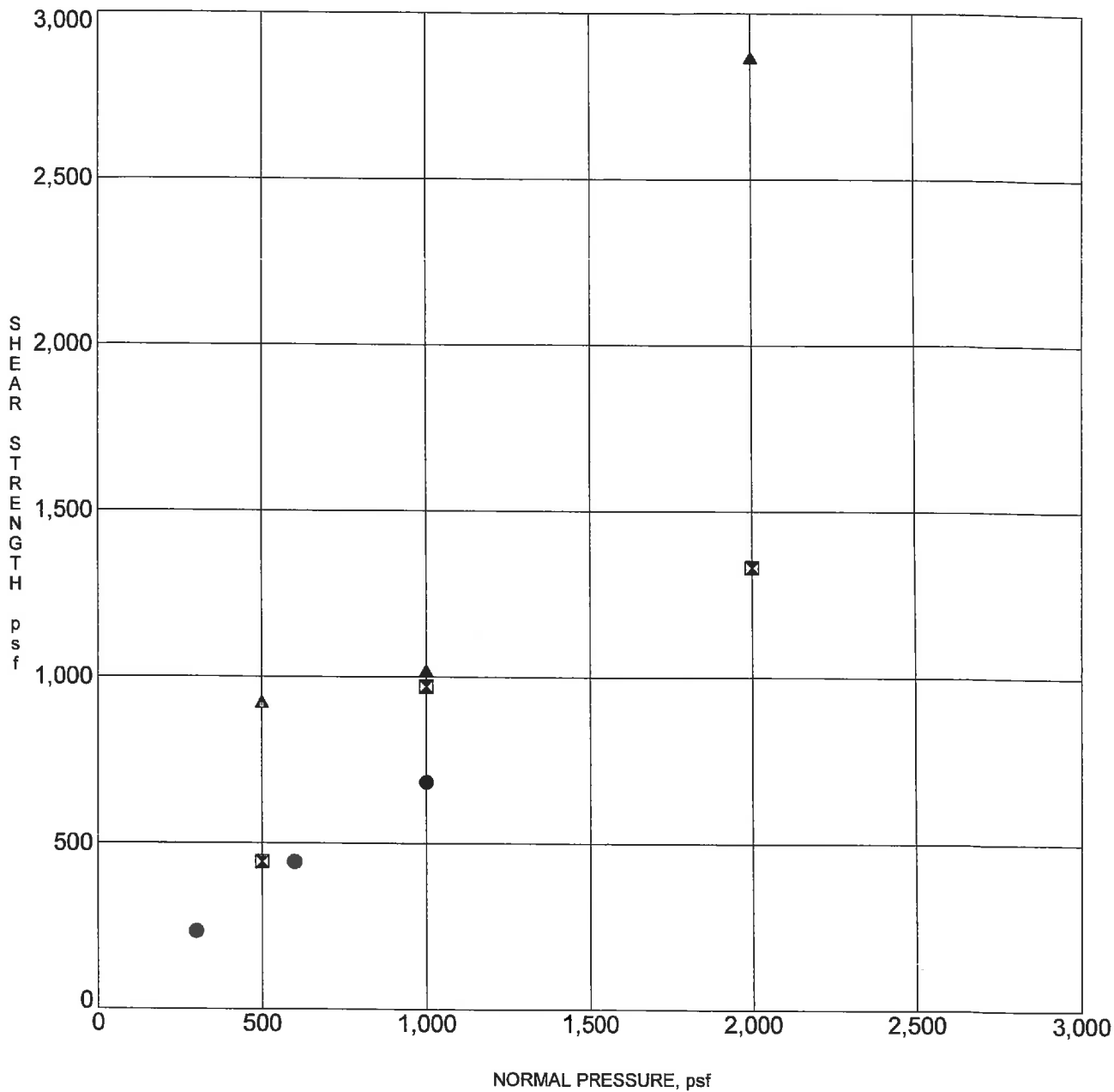

***NOTE-ULTIMATE STRENGTH VALUES**

Specimen Identification	Soil Type/Classification	Cohesion	Friction Angle	DD	MC%
● GHTP-2 4.0	ALLUVIUM			72.0	48.9
⊗ GHTP-2 6.0	ALLUVIUM			70.1	42.5
▲ GHTP-2 8.0	ALLUVIUM			74.7	53.7

PROJECT **Harvard Westlake School - 3701 thru 3801 N.**
Coldwater Canyon Avenue, Los Angeles

JOB NO. **16870-G**
 DATE **10/14**

SHEAR TEST DIAGRAM

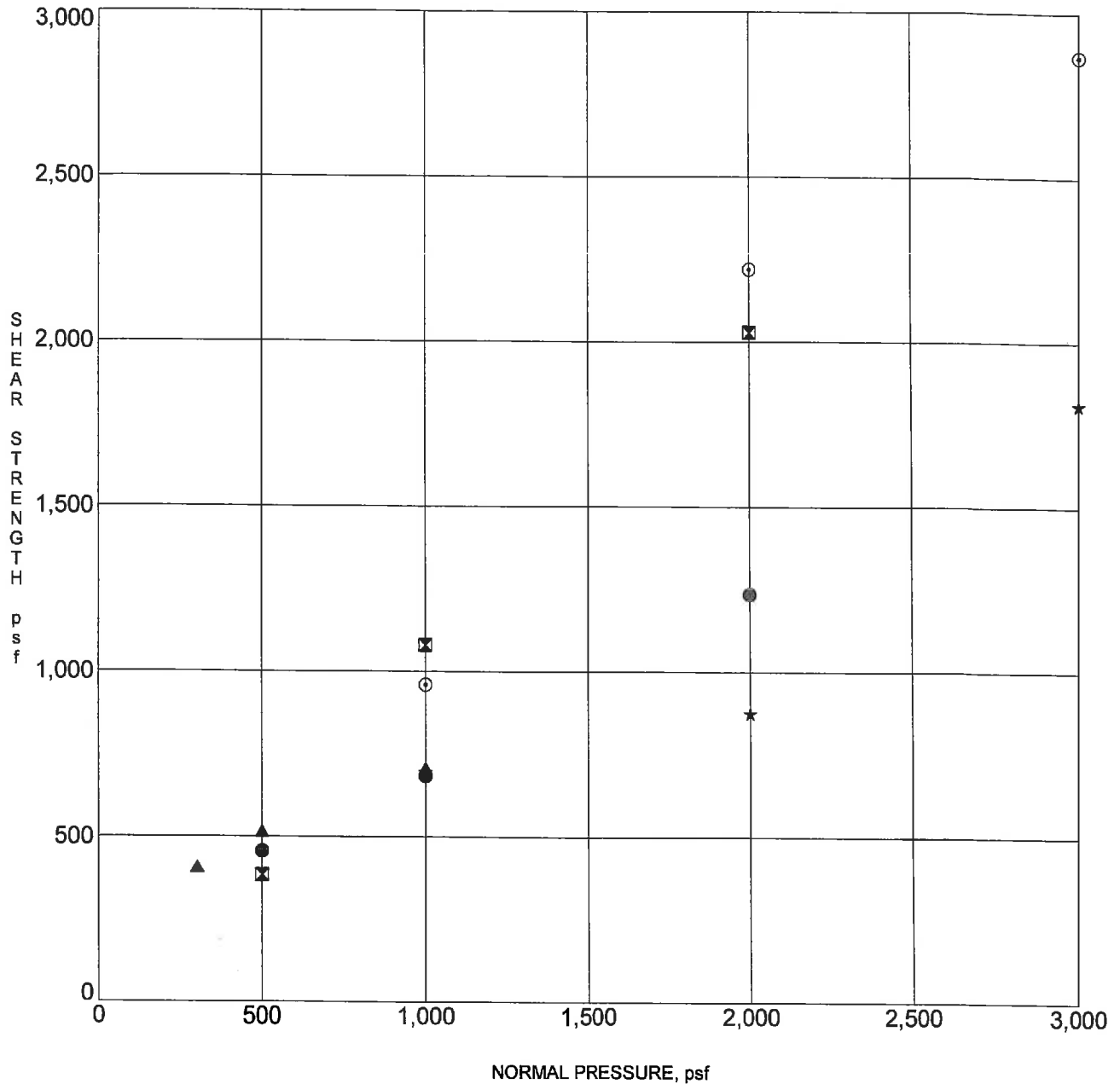

*NOTE-ULTIMATE STRENGTH VALUES

Specimen Identification	Soil Type/Classification	Cohesion	Friction Angle	DD	MC%
● GHB-2 10.0	ALLUVIUM			75.4	40.0
☒ GHB-5 10.0	ALLUVIUM			69.6	38.7
▲ GHB-6 5.0	ALLUVIUM			62.7	40.7
★ GHB-6 15.0	ALLUVIUM			67.9	38.9
⊙ GHB-7 15.0	ALLUVIUM			68.5	41.3

PROJECT Harvard Westlake School - 3701 thru 3801 N.
Coldwater Canyon Avenue, Los Angeles

JOB NO. 16870-G
 DATE 10/14

SHEAR TEST DIAGRAM

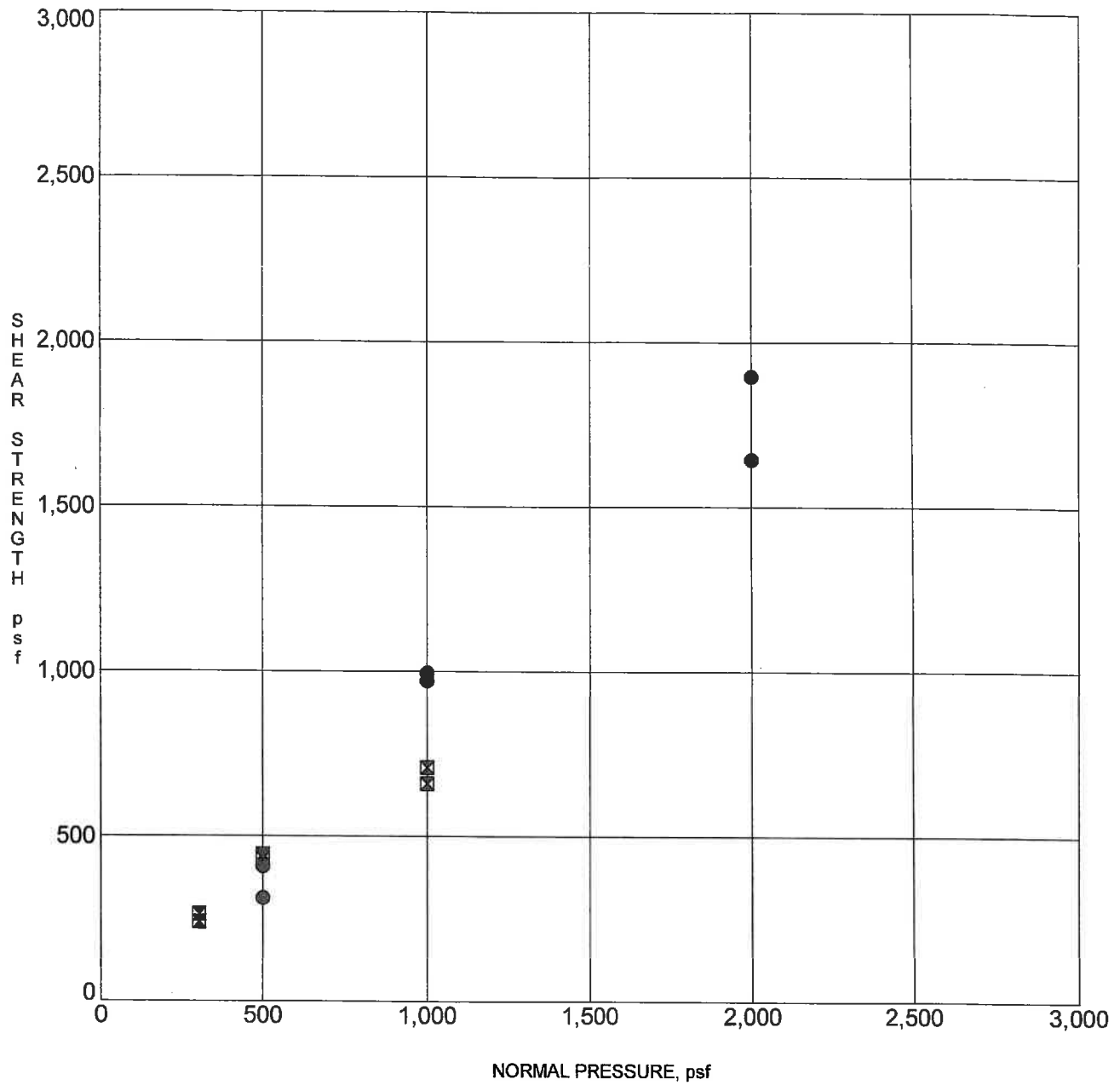

*NOTE-RESIDUAL STRENGTH VALUES

Specimen Identification	Soil Type/Classification	Cohesion	Friction Angle	DD	MC%
● GHB-5 10.0	ALLUVIUM				20.0
⊗ GHB-6 5.0	ALLUVIUM			62.7	40.7

PROJECT Harvard Westlake School - 3701 thru 3801 N.
Coldwater Canyon Avenue, Los Angeles

JOB NO. 16870-G
 DATE 10/14

SHEAR TEST DIAGRAM

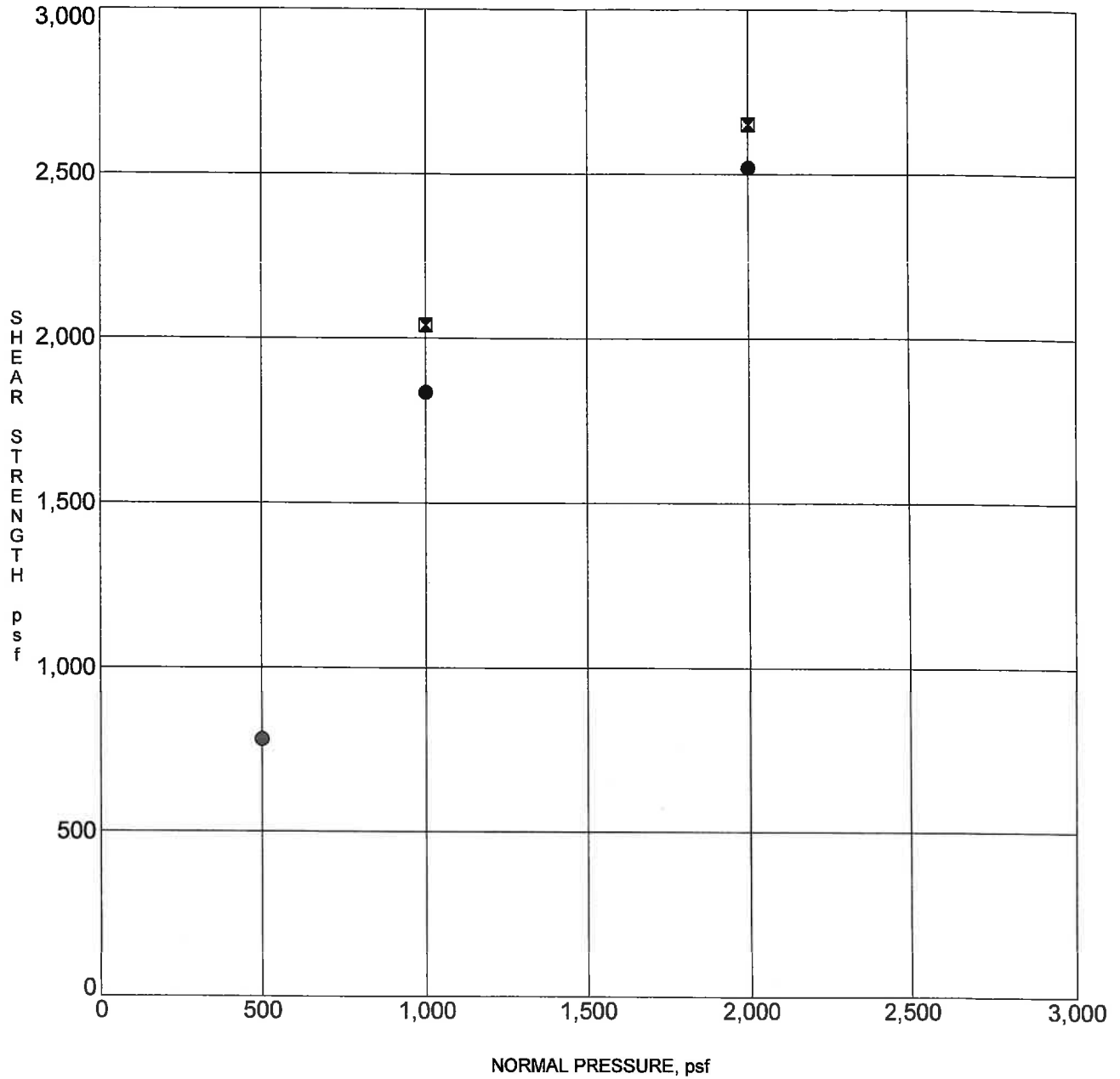

***NOTE-ULTIMATE STRENGTH VALUES**

Specimen Identification	Soil Type/Classification	Cohesion	Friction Angle	DD	MC%
● GHB-3	11.0 WEATHERED BEDROCK			76.2	47.1
⊠ GHB-6	25.0 WEATHERED BEDROCK			77.9	52.5

PROJECT Harvard Westlake School - 3701 thru 3801 N.
Coldwater Canyon Avenue, Los Angeles

JOB NO. 16870-G
DATE 10/14

SHEAR TEST DIAGRAM

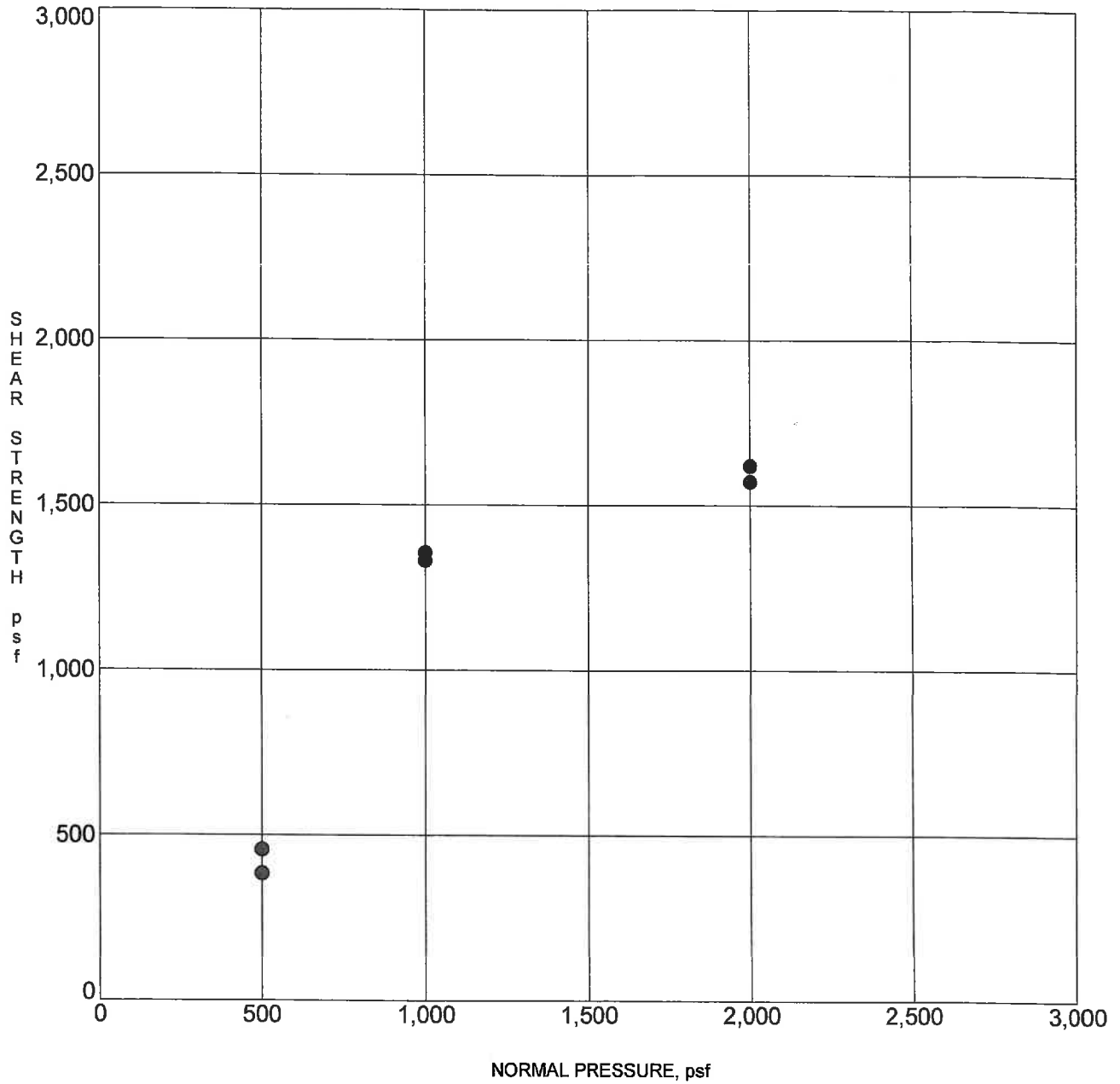

*NOTE-RESIDUAL STRENGTH VALUES

Specimen Identification	Soil Type/Classification	Cohesion	Friction Angle	DD	MC%
● GHB-3 11.0	WEATHERED BEDROCK			76.2	47.1

PROJECT Harvard Westlake School - 3701 thru 3801 N.
Coldwater Canyon Avenue, Los Angeles

JOB NO. 16870-G
 DATE 10/14

SHEAR TEST DIAGRAM

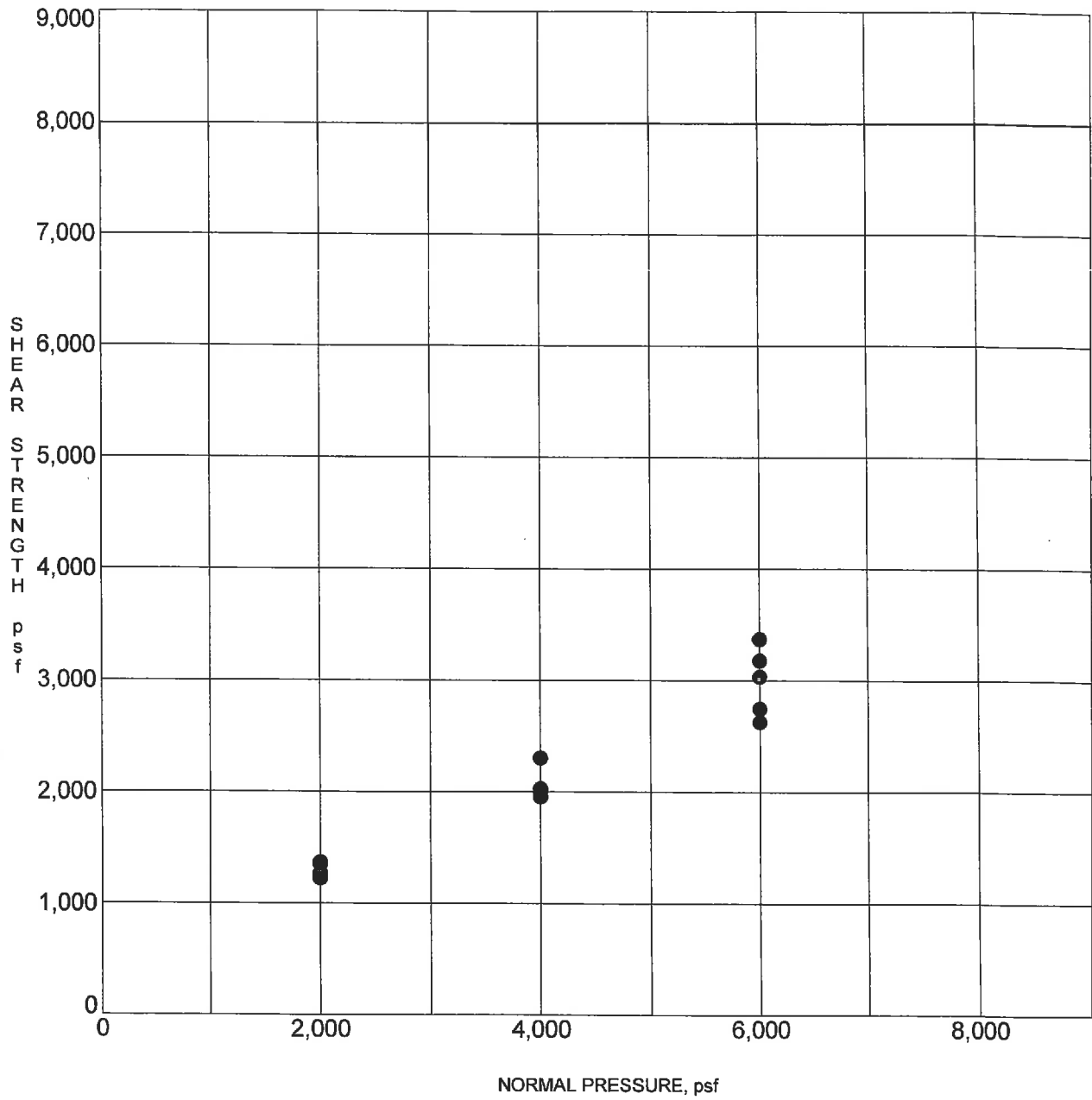

***NOTE-RESIDUAL STRENGTH VALUES**

●	Specimen Identification	Soil Type/Classification	Cohesion	Friction Angle	DD	MC%
	GHB-3	SHEARED BEDROCK	23.5		78.8	46.1

PROJECT **Harvard Westlake School - 3701 thru 3801 N.
Coldwater Canyon Avenue, Los Angeles**

JOB NO. **16870-G**
DATE **10/14**

SHEAR TEST DIAGRAM

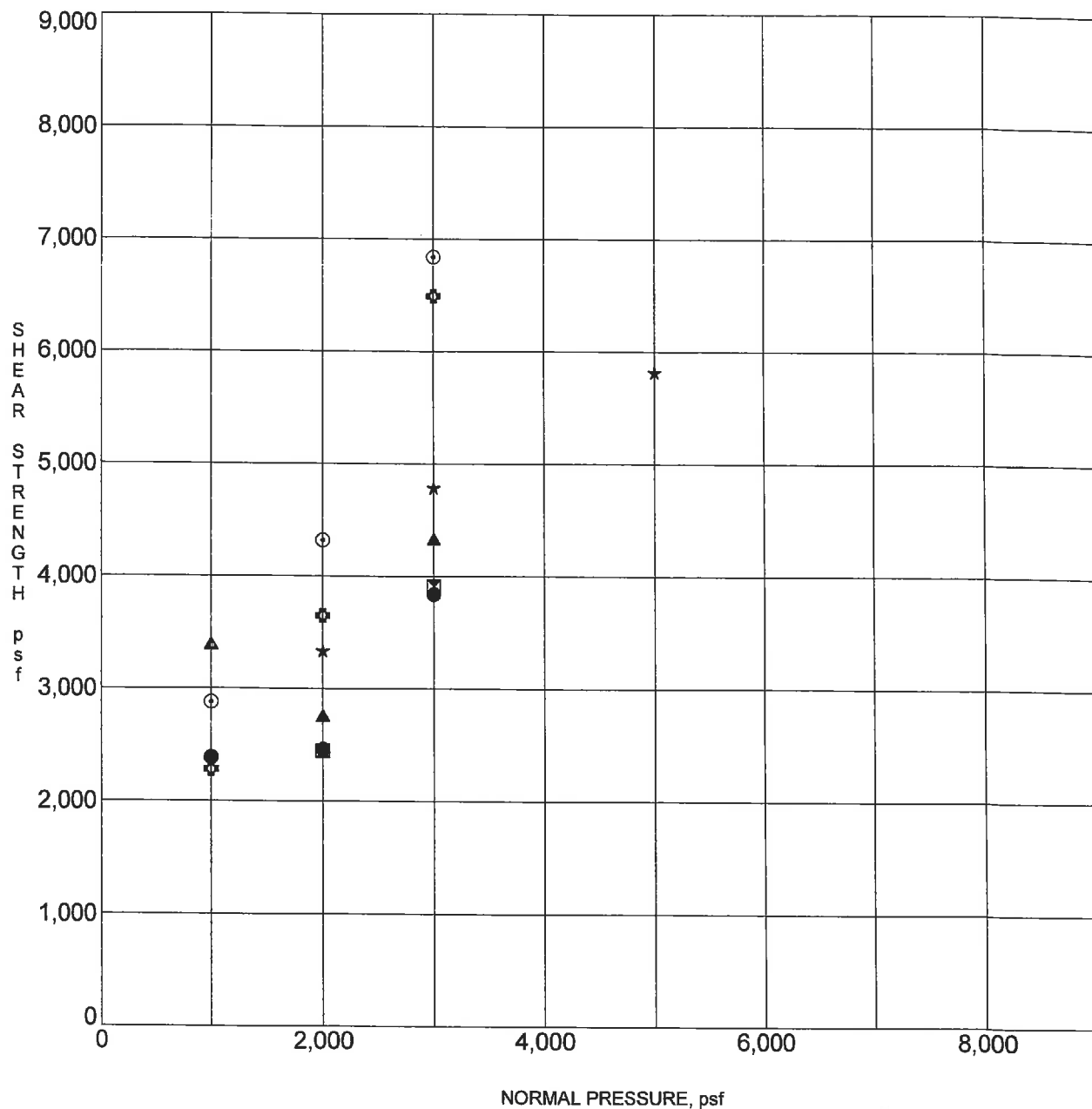

*NOTE-PEAK STRENGTH VALUES

Specimen Identification	Soil Type/Classification	Cohesion	Friction Angle	DD	MC%
● GHB-1 15.0	BEDROCK			69.6	63.5
☒ GHB-1 25.0	BEDROCK			65.2	65.3
▲ GHB-2 20.0	BEDROCK			50.4	90.9
★ GHB-2 30.0	BEDROCK			45.0	114.7
⊙ GHB-4 15.0	BEDROCK			62.3	73.4
⊕ GHB-7 25.0	BEDROCK			46.1	106.3

PROJECT **Harvard Westlake School - 3701 thru 3801 N.
Coldwater Canyon Avenue, Los Angeles**

JOB NO. **16870-G**
DATE **10/14**

SHEAR TEST DIAGRAM

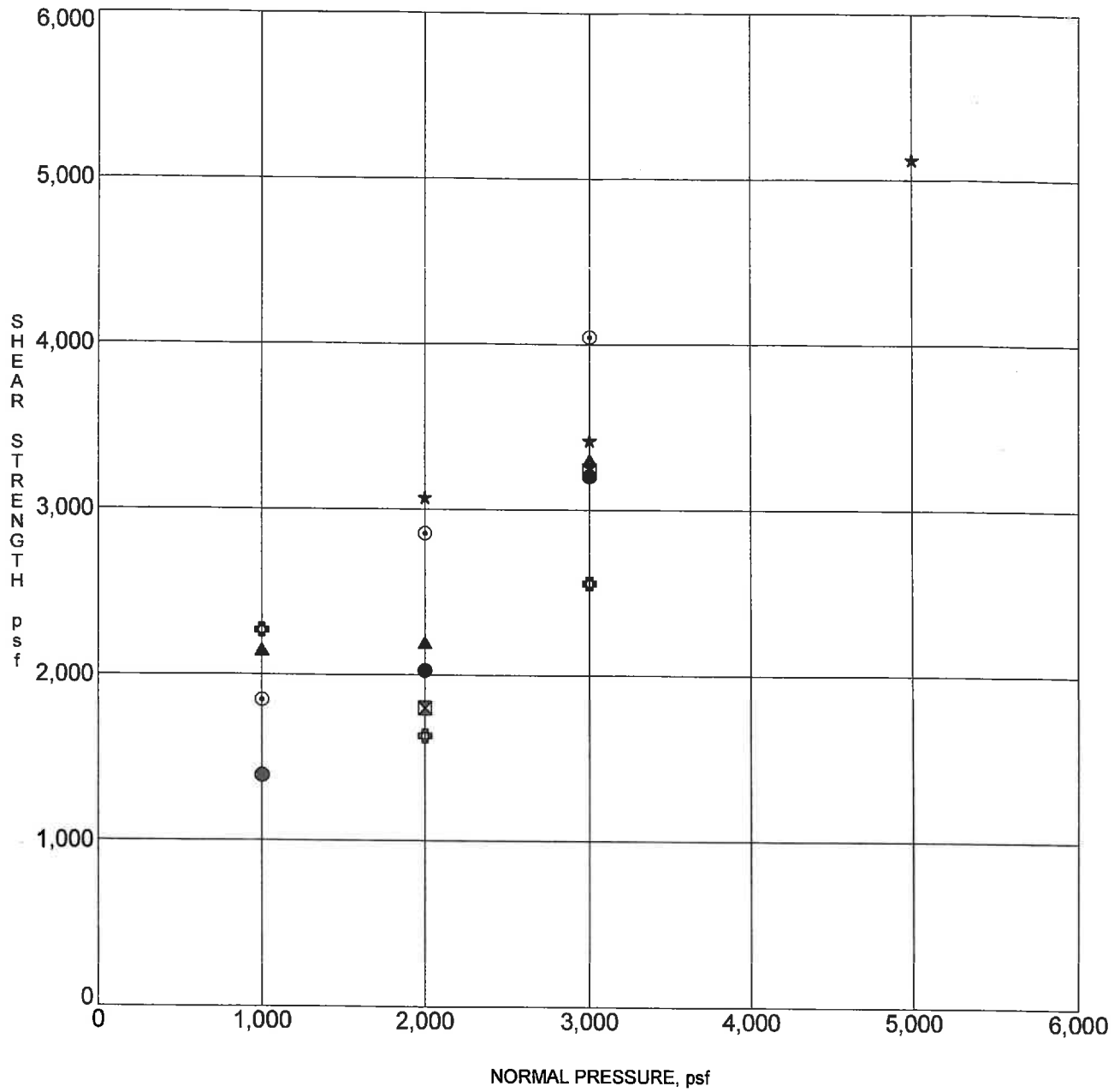

*NOTE-ULTIMATE STRENGTH VALUES

Specimen Identification	Soil Type/Classification	Cohesion	Friction Angle	DD	MC%
● GHB-1 15.0	BEDROCK			69.6	63.5
⊗ GHB-1 25.0	BEDROCK			65.2	65.3
▲ GHB-2 20.0	BEDROCK			50.4	90.9
★ GHB-2 30.0	BEDROCK			45.0	114.7
⊙ GHB-4 15.0	BEDROCK			62.3	73.4
⊕ GHB-7 25.0	BEDROCK			46.1	106.3

PROJECT Harvard Westlake School - 3701 thru 3801 N.
Coldwater Canyon Avenue, Los Angeles

JOB NO. 16870-G
DATE 10/14

SHEAR TEST DIAGRAM

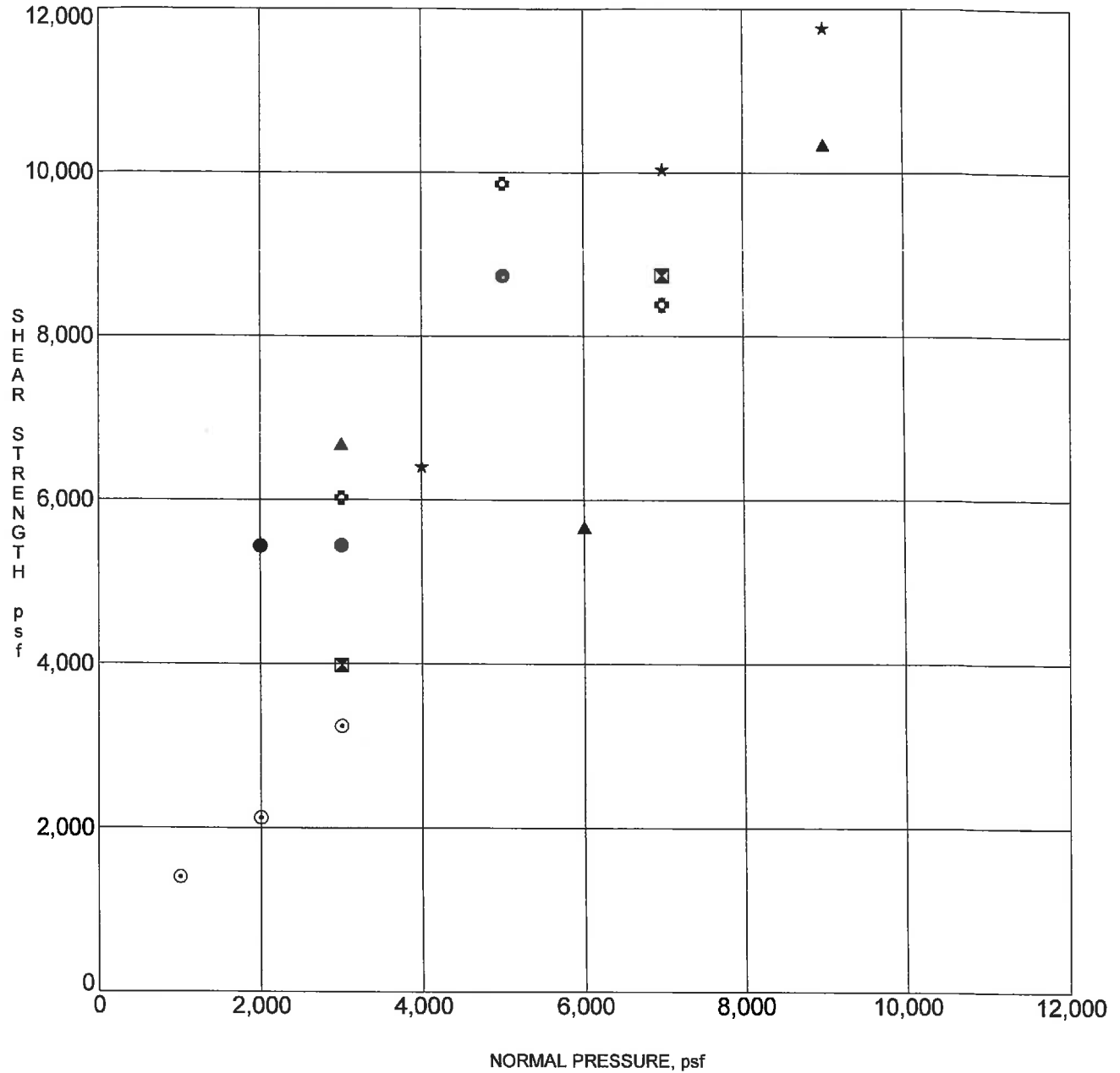

*NOTE-PEAK STRENGTH VALUES

Specimen Identification	Soil Type/Classification	Cohesion	Friction Angle	DD	MC%
● GHB-2 35.0	BEDROCK			54.8	78.6
⊠ GHB-2 50.0	BEDROCK			48.9	108.3
▲ GHB-2 60.0	BEDROCK			50.6	86.0
★ GHB-2 70.0	BEDROCK			74.3	42.1
⊙ GHB-4 35.0	BEDROCK			50.3	93.2
⊕ GHB-4 54.0	BEDROCK			55.2	83.1

PROJECT Harvard Westlake School - 3701 thru 3801 N.
Coldwater Canyon Avenue, Los Angeles

JOB NO. 16870-G
DATE 10/14

SHEAR TEST DIAGRAM

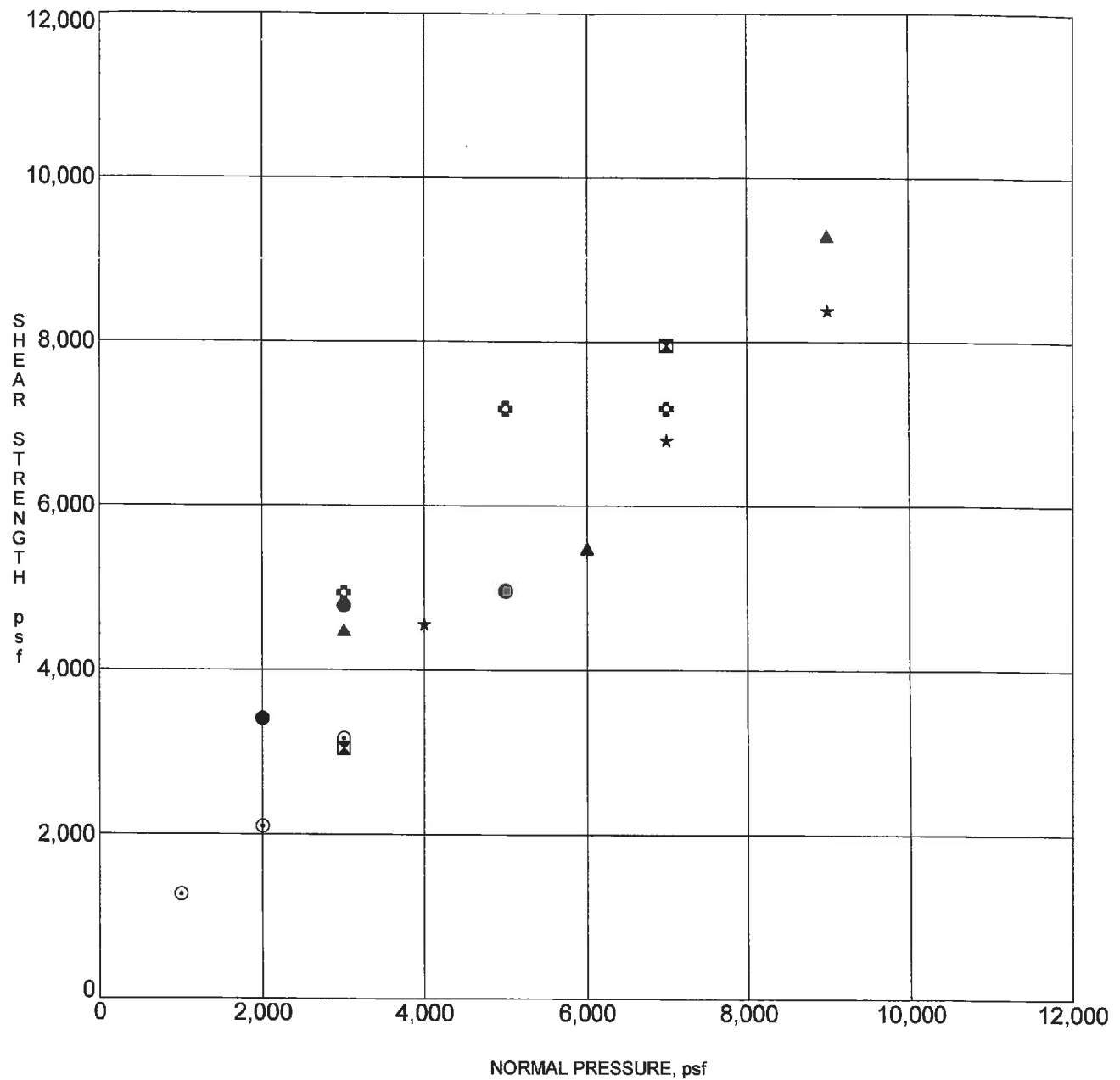

*NOTE-ULTIMATE STRENGTH VALUES

Specimen Identification	Soil Type/Classification	Cohesion	Friction Angle	DD	MC%
● GHB-2 35.0	BEDROCK			54.8	78.6
⊠ GHB-2 50.0	BEDROCK			48.9	108.3
▲ GHB-2 60.0	BEDROCK			50.6	86.0
★ GHB-2 70.0	BEDROCK			74.3	42.1
⊕ GHB-4 35.0	BEDROCK			50.3	93.2
⊞ GHB-4 54.0	BEDROCK			55.2	83.1

PROJECT **Harvard Westlake School - 3701 thru 3801 N.
Coldwater Canyon Avenue, Los Angeles**

JOB NO. **16870-G**
DATE **10/14**

Grover-Hollingsworth and Associates
Westlake Village, CA 91362

PLATE B-11

SHEAR TEST DIAGRAM

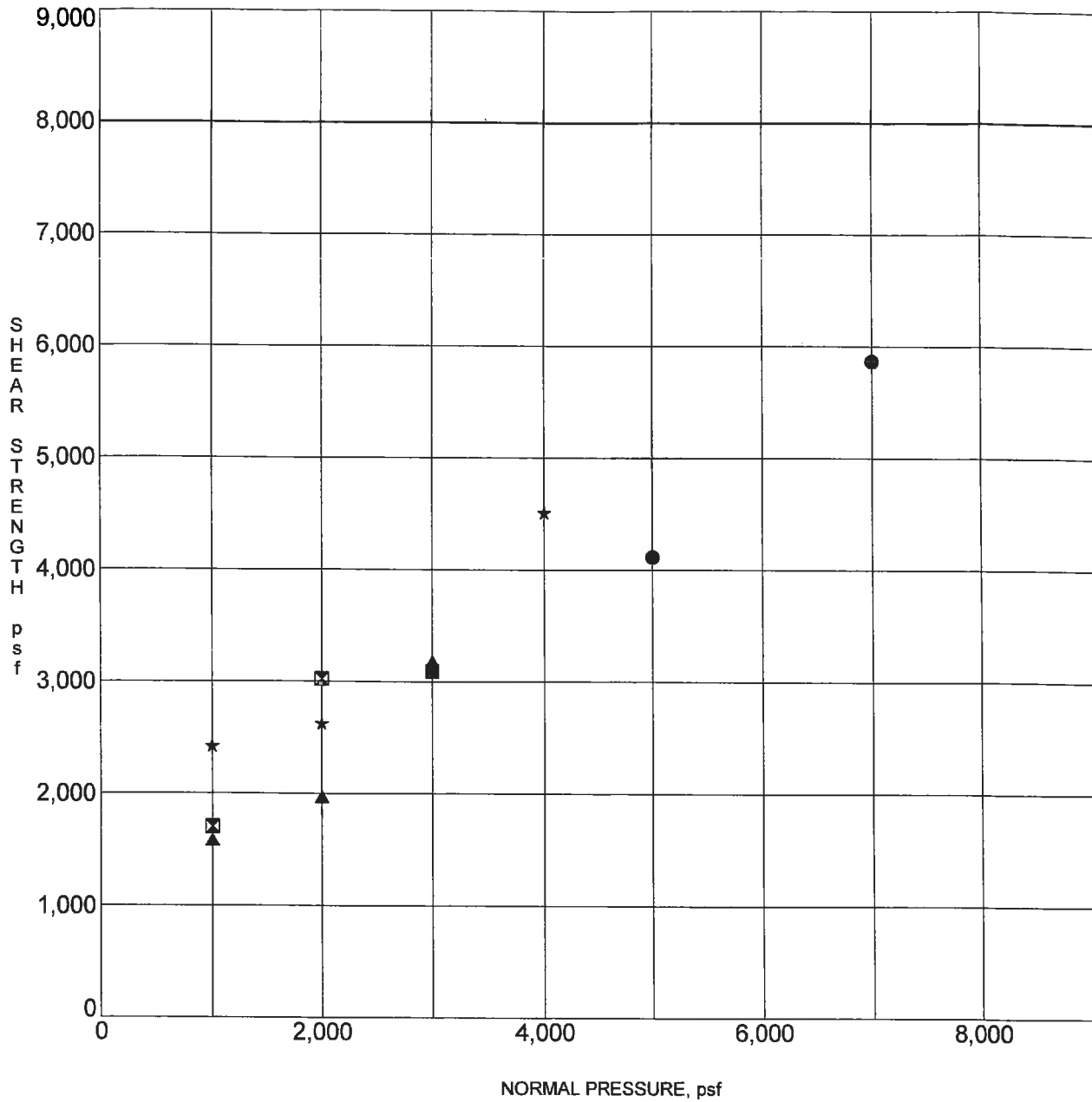

*NOTE-PEAK STRENGTH VALUES

Specimen Identification	Soil Type/Classification	Cohesion	Friction Angle	DD	MC%
● GHB-1	45.0 BEDROCK			73.5	51.6
☒ GHB-3	20.0 BEDROCK			82.9	47.3
▲ GHB-3	25.0 BEDROCK			56.2	86.1
★ GHB-3	30.0 BEDROCK			46.5	107.6

PROJECT **Harvard Westlake School - 3701 thru 3801 N.
Coldwater Canyon Avenue, Los Angeles**

JOB NO. **16870-G**
DATE **10/14**

SHEAR TEST DIAGRAM

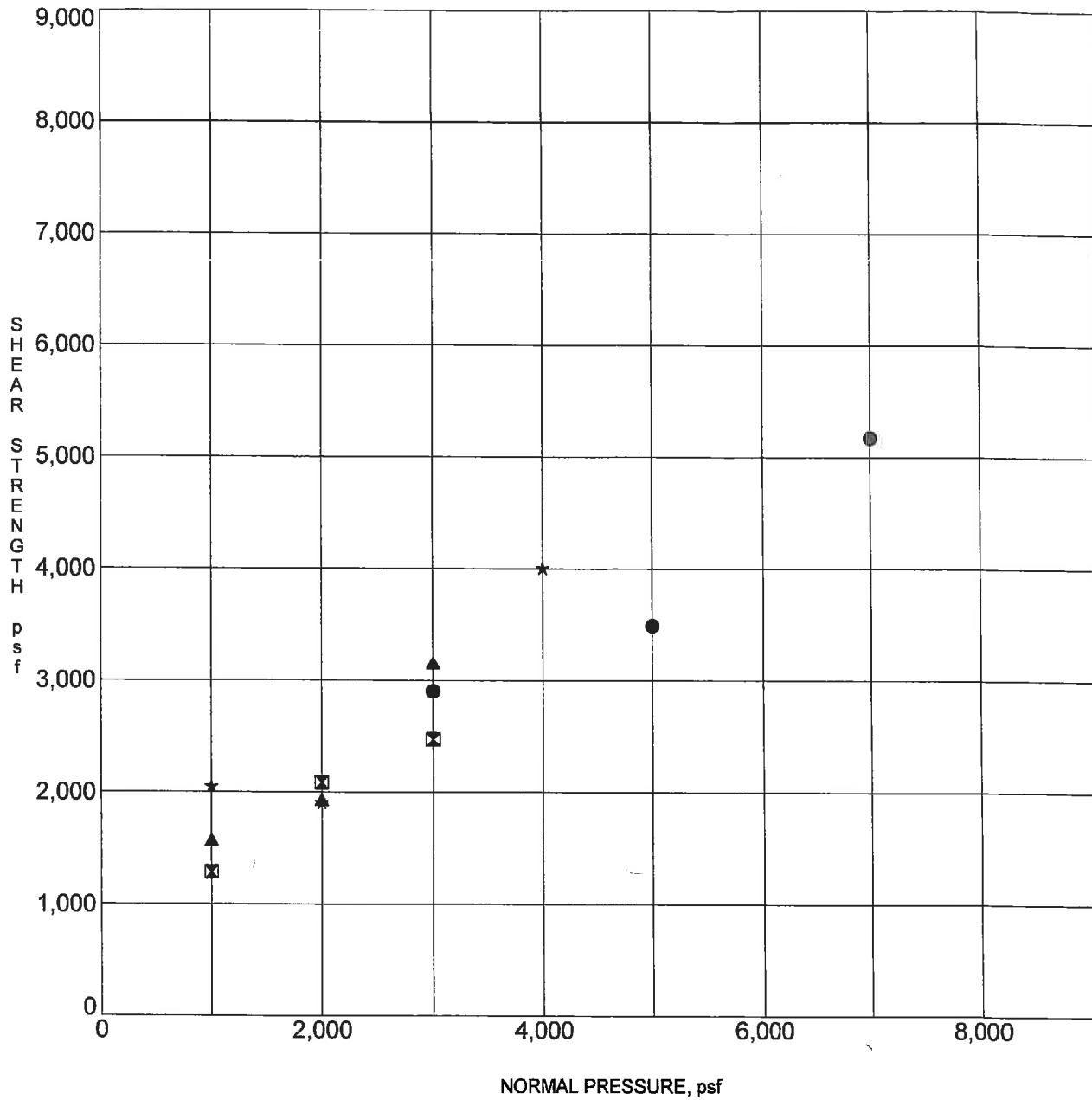

*NOTE-ULTIMATE STRENGTH VALUES

Specimen Identification	Soil Type/Classification	Cohesion	Friction Angle	DD	MC%
● GHB-1	45.0	BEDROCK		73.5	51.6
◻ GHB-3	20.0	BEDROCK		82.9	47.3
▲ GHB-3	25.0	BEDROCK		56.2	86.1
★ GHB-3	30.0	BEDROCK		46.5	107.6

PROJECT **Harvard Westlake School - 3701 thru 3801 N.
Coldwater Canyon Avenue, Los Angeles**

JOB NO. **16870-G**
DATE **10/14**

SHEAR TEST DIAGRAM

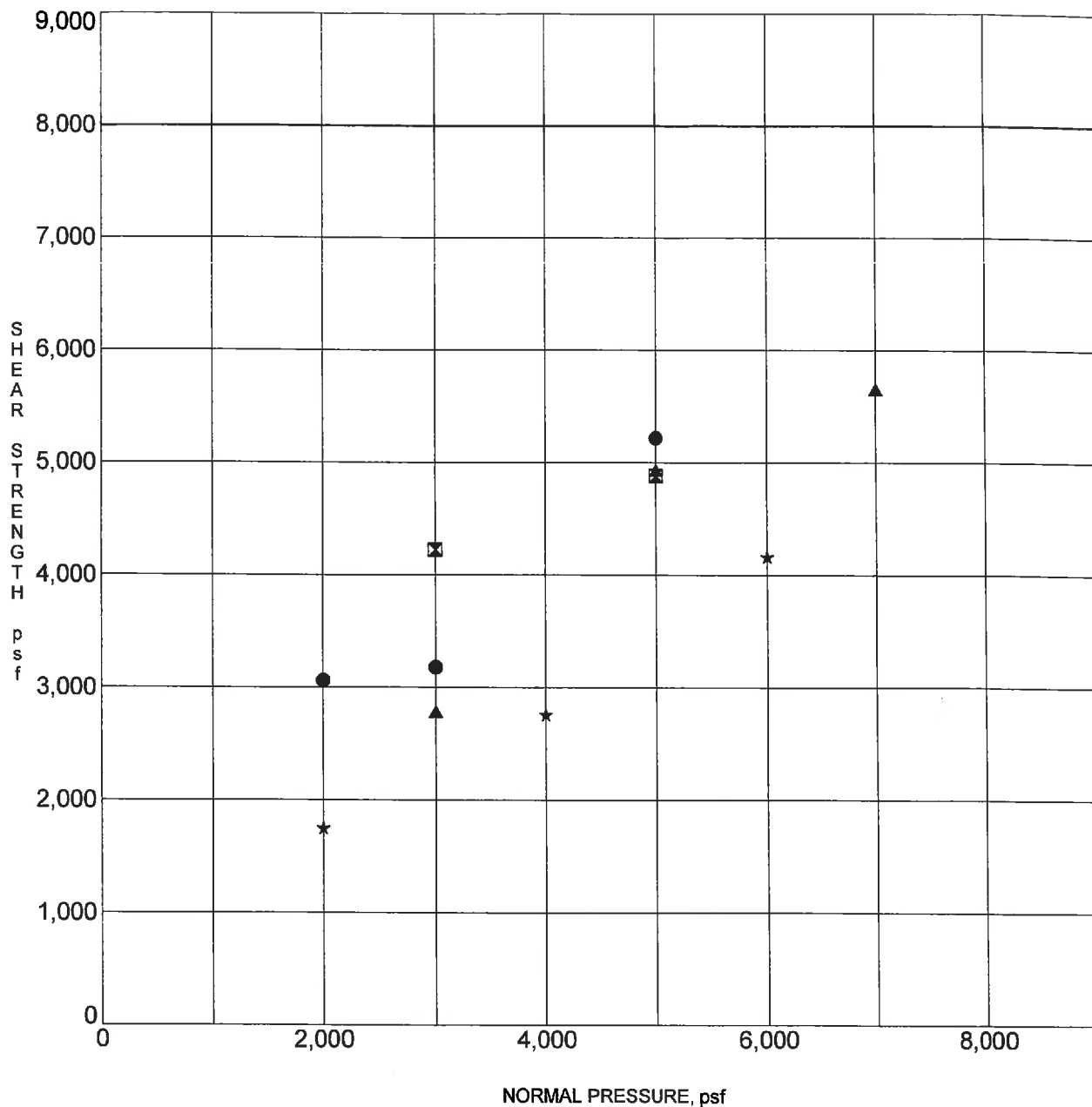

*NOTE-PEAK STRENGTH VALUES

Specimen Identification	Soil Type/Classification	Cohesion	Friction Angle	DD	MC%
● GHB-1 35.0	BEDROCK			86.7	35.4
☒ GHB-1 50.0	BEDROCK-CUT			86.2	36.3
▲ GHB-1 52.0	BEDROCK			85.5	45.0
★ GHB-6 35.0	BEDROCK			73.7	47.9

PROJECT Harvard Westlake School - 3701 thru 3801 N.
Coldwater Canyon Avenue, Los Angeles

JOB NO. 16870-G
 DATE 10/14

SHEAR TEST DIAGRAM

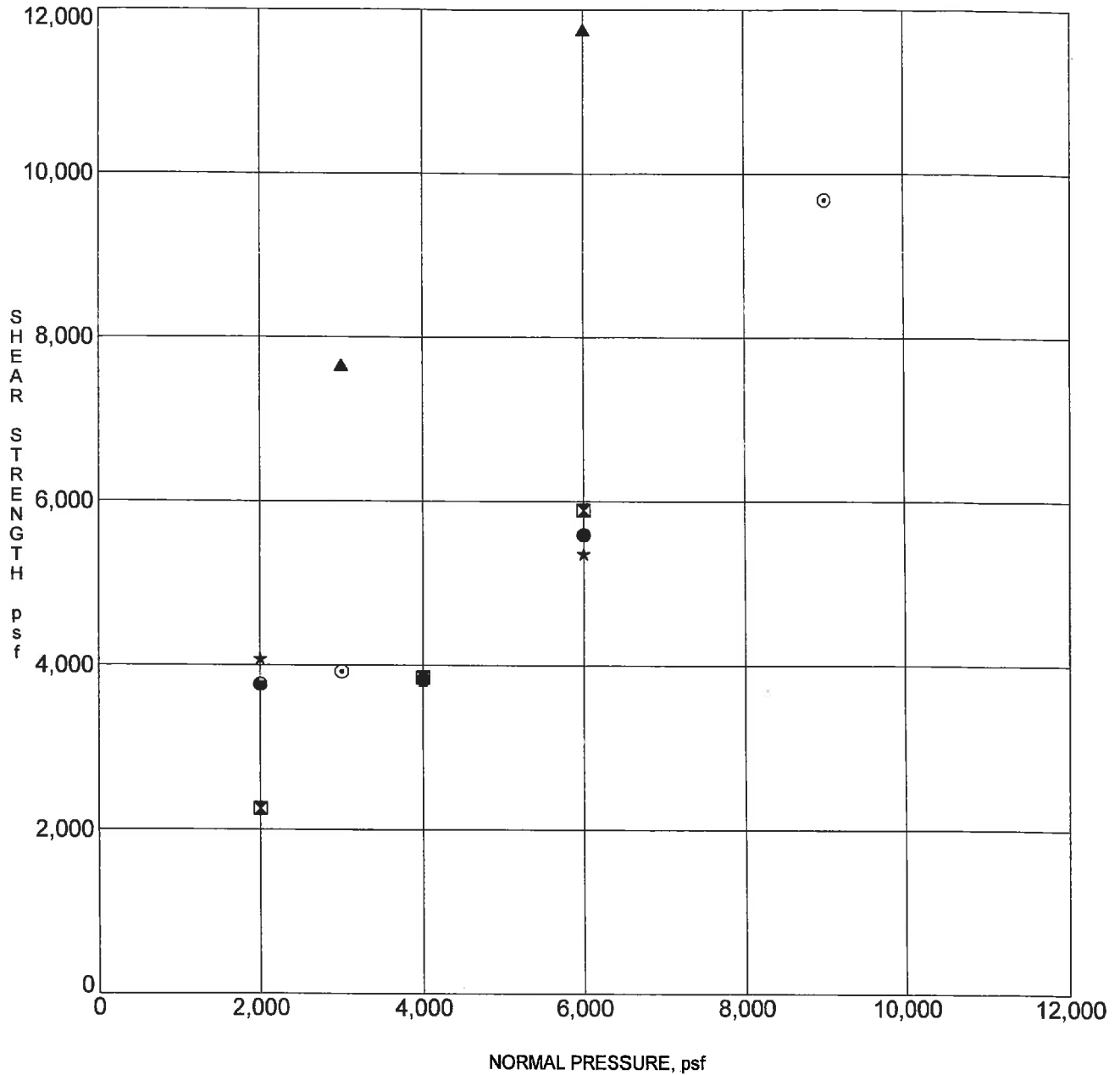

*NOTE-PEAK STRENGTH VALUES

Specimen Identification	Soil Type/Classification	Cohesion	Friction Angle	DD	MC%
● GHB-3 35.0	BEDROCK-CUT			48.6	96.8
⊠ GHB-3 40.0	BEDROCK			44.3	110.7
▲ GHB-4 67.0	BEDROCK-CUT			85.8	35.8
★ GHB-5 50.0	BEDROCK			74.1	51.1
⊙ GHB-5 60.0	BEDROCK			85.7	41.5

PROJECT **Harvard Westlake School - 3701 thru 3801 N.
Coldwater Canyon Avenue, Los Angeles**

JOB NO. **16870-G**
DATE **10/14**

SHEAR TEST DIAGRAM

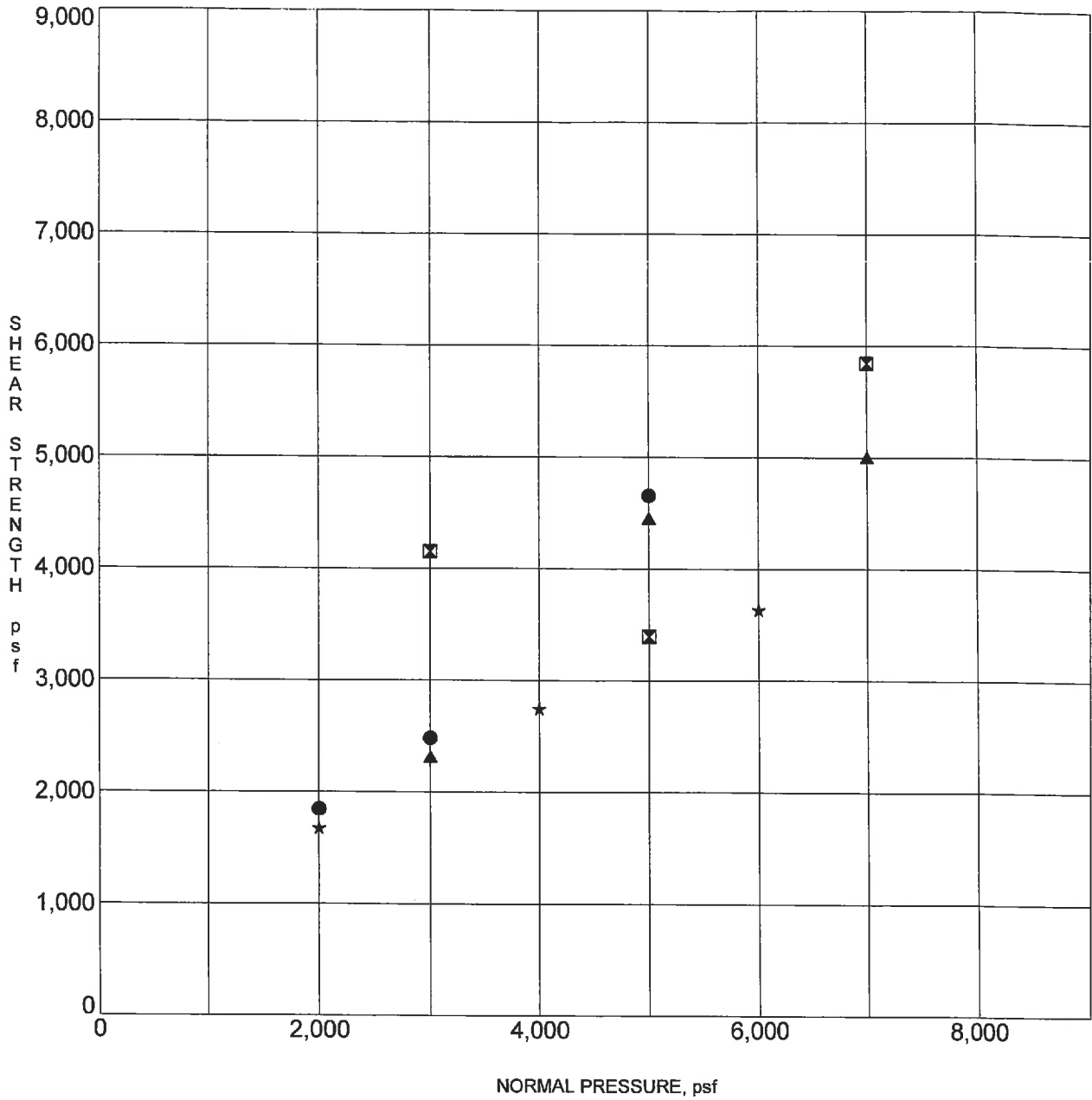

*NOTE-ULTIMATE STRENGTH VALUES

Specimen Identification	Soil Type/Classification	Cohesion	Friction Angle	DD	MC%
● GHB-1 35.0	BEDROCK			86.7	35.4
⊠ GHB-1 50.0	BEDROCK-CUT			86.2	36.3
▲ GHB-1 52.0	BEDROCK			85.5	45.0
★ GHB-6 35.0	BEDROCK			73.7	47.9

PROJECT **Harvard Westlake School - 3701 thru 3801 N.
Coldwater Canyon Avenue, Los Angeles**

JOB NO. **16870-G**
DATE **10/14**

SHEAR TEST DIAGRAM

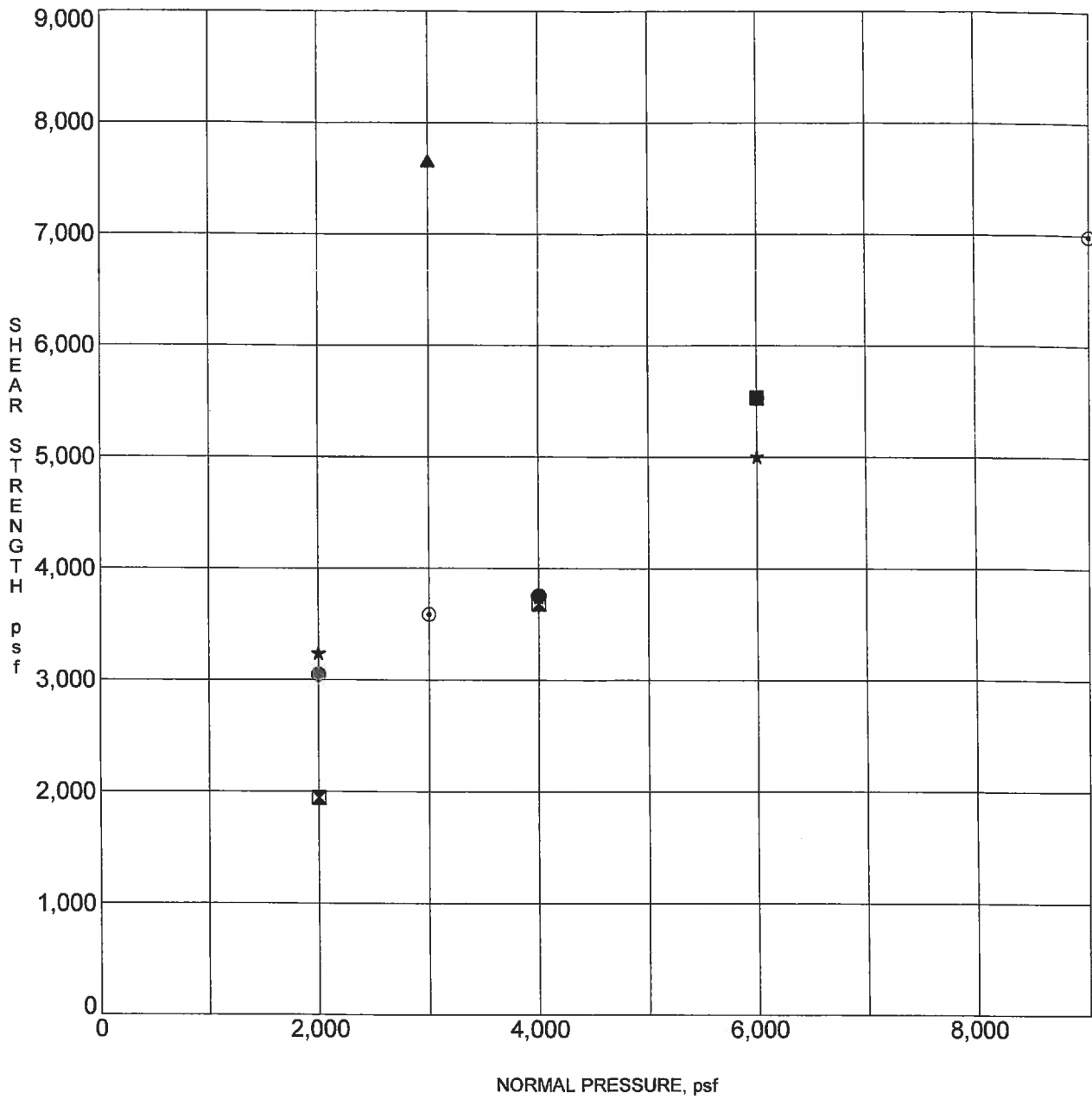

*NOTE-ULTIMATE STRENGTH VALUES

Specimen Identification	Soil Type/Classification	Cohesion	Friction Angle	DD	MC%
● GHB-3 35.0	BEDROCK-CUT			48.6	96.8
⊠ GHB-3 40.0	BEDROCK			44.3	110.7
▲ GHB-4 67.0	BEDROCK-CUT			85.8	35.8
★ GHB-5 50.0	BEDROCK			74.1	51.1
⊙ GHB-5 60.0	BEDROCK			85.7	41.5

PROJECT Harvard Westlake School - 3701 thru 3801 N.
Coldwater Canyon Avenue, Los Angeles

JOB NO. 16870-G
DATE 10/14

Grover-Hollingsworth and Associates
Westlake Village, CA 91362

PLATE B-15a

PLASTICITY INDEX

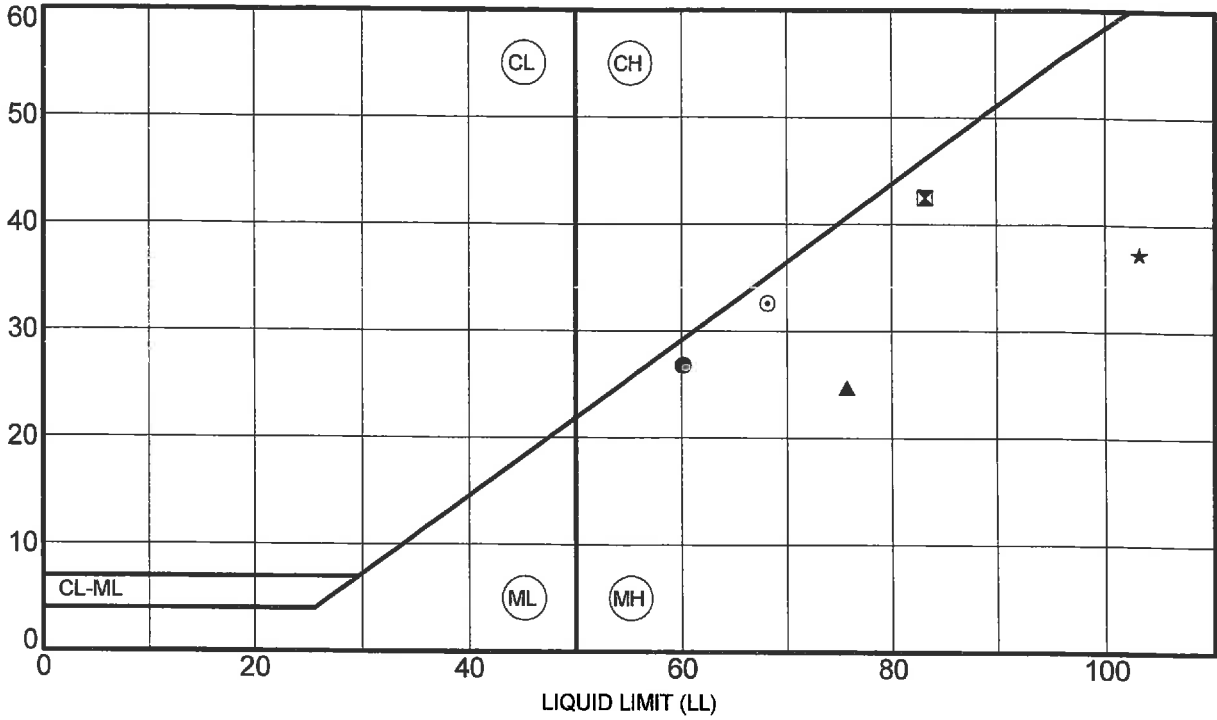

Specimen Identification	LL	PL	PI	Fines	Classification
● GHB-1	35.0	60	33	27	BEDROCK
⊠ GHB-3	23.5	83	41	42	SHEAR SURFACE
▲ GHB-3	40.0	76	51	25	BEDROCK
★ GHB-4	15.0	103	66	37	BEDROCK
⊙ GHB-6	25.0	68	36	32	BEDROCK

PROJECT **HARVARD WESTLAKE SCHOOL - 3701 thru 3801** JOB NO. **16870-G**
N. Coldwater Canyon Avenue, Los Angeles DATE _____

ATTERBERG LIMITS' RESULTS
 Grover-Hollingsworth and Associates
 Westlake Village, CA 91362

PLATE F

GH: 16870-G
CLIENT: Harvard-Westlake
DATE: 11/2014
SAMPLE ID: GHTP-2 @4'

DIRECT SHEAR TEST

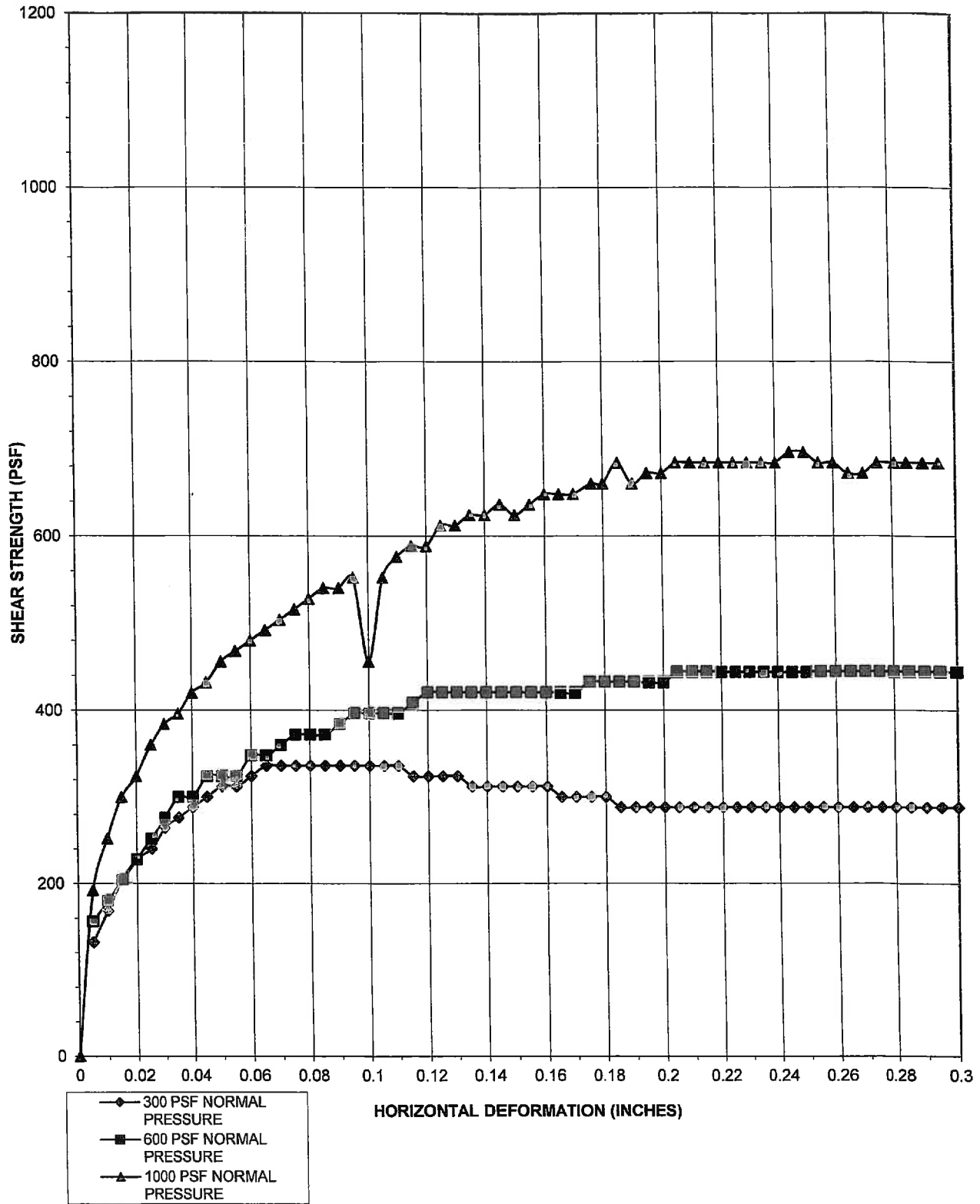

GH: 16870-G
CLIENT: Harvard-Westlake
DATE: 12/2014
SAMPLE ID: GHTP-2 @6ft

DIRECT SHEAR TEST

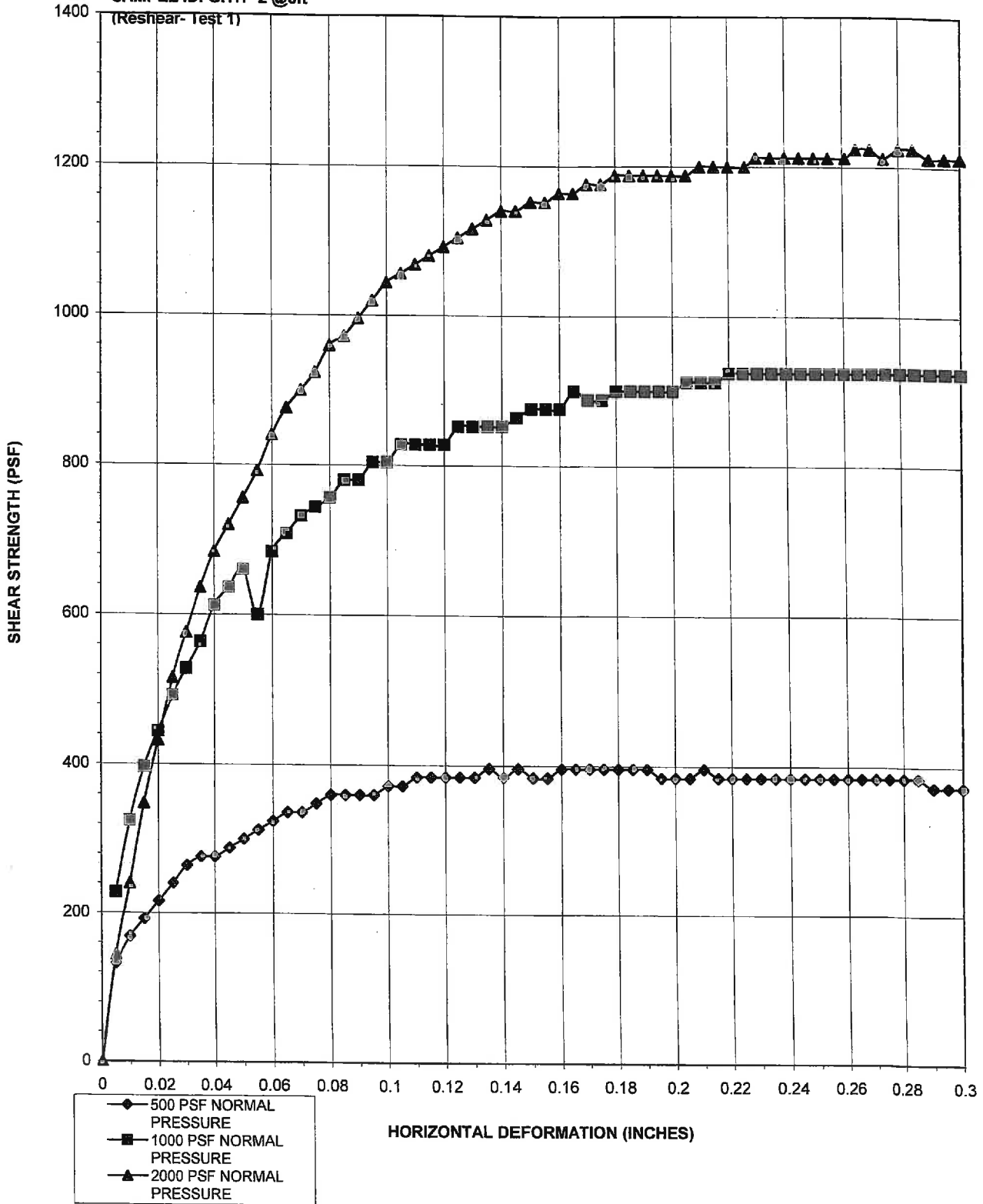

GH: 16870-G
CLIENT: Harvard-Westlake
DATE: 12/2014
SAMPLE ID: GHTP-2 @6ft

DIRECT SHEAR TEST

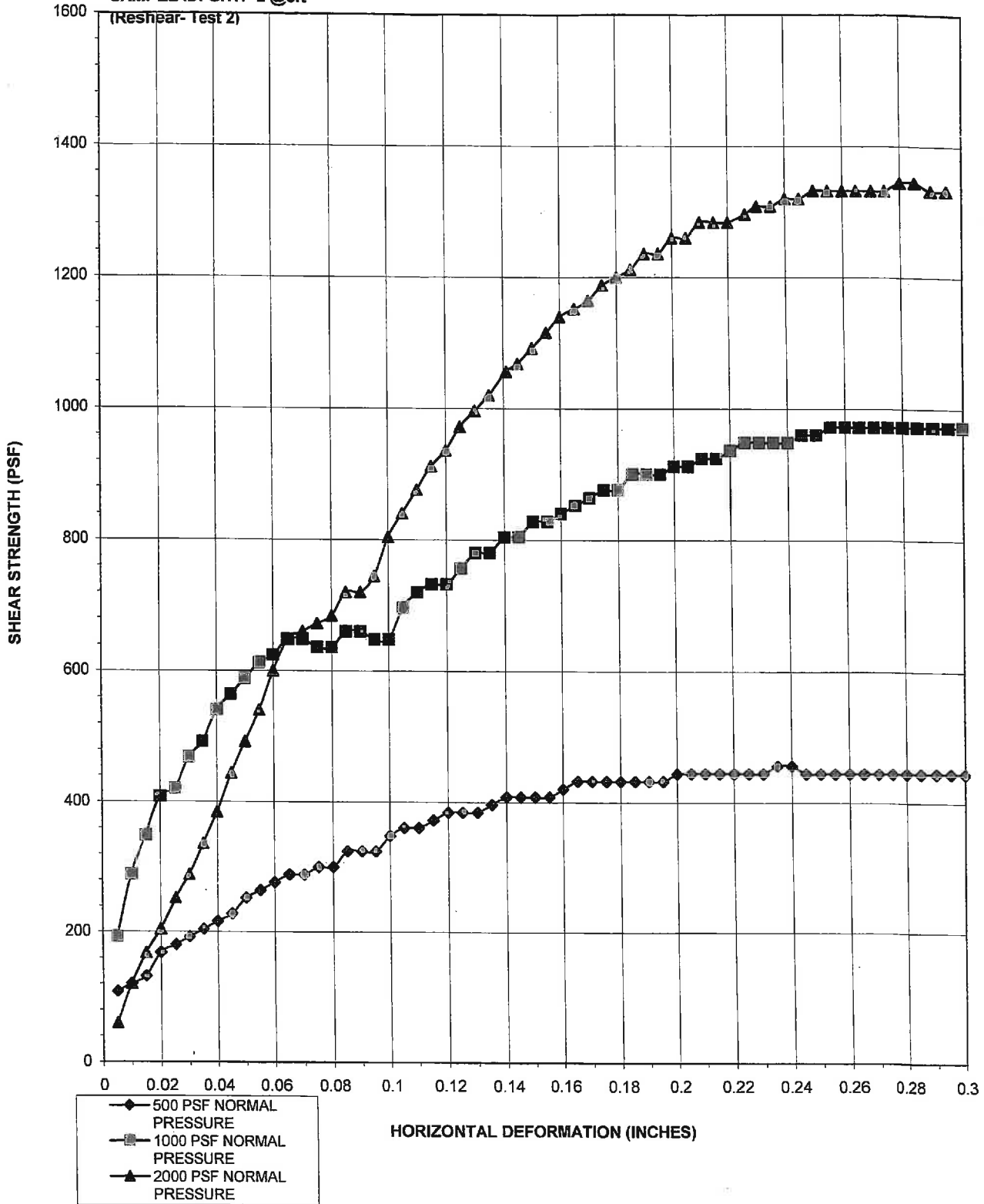

GH: 16870-G
CLIENT: Harvard-Westlake
DATE: 11/2014
SAMPLE ID: GHTP-2 @8'

DIRECT SHEAR TEST

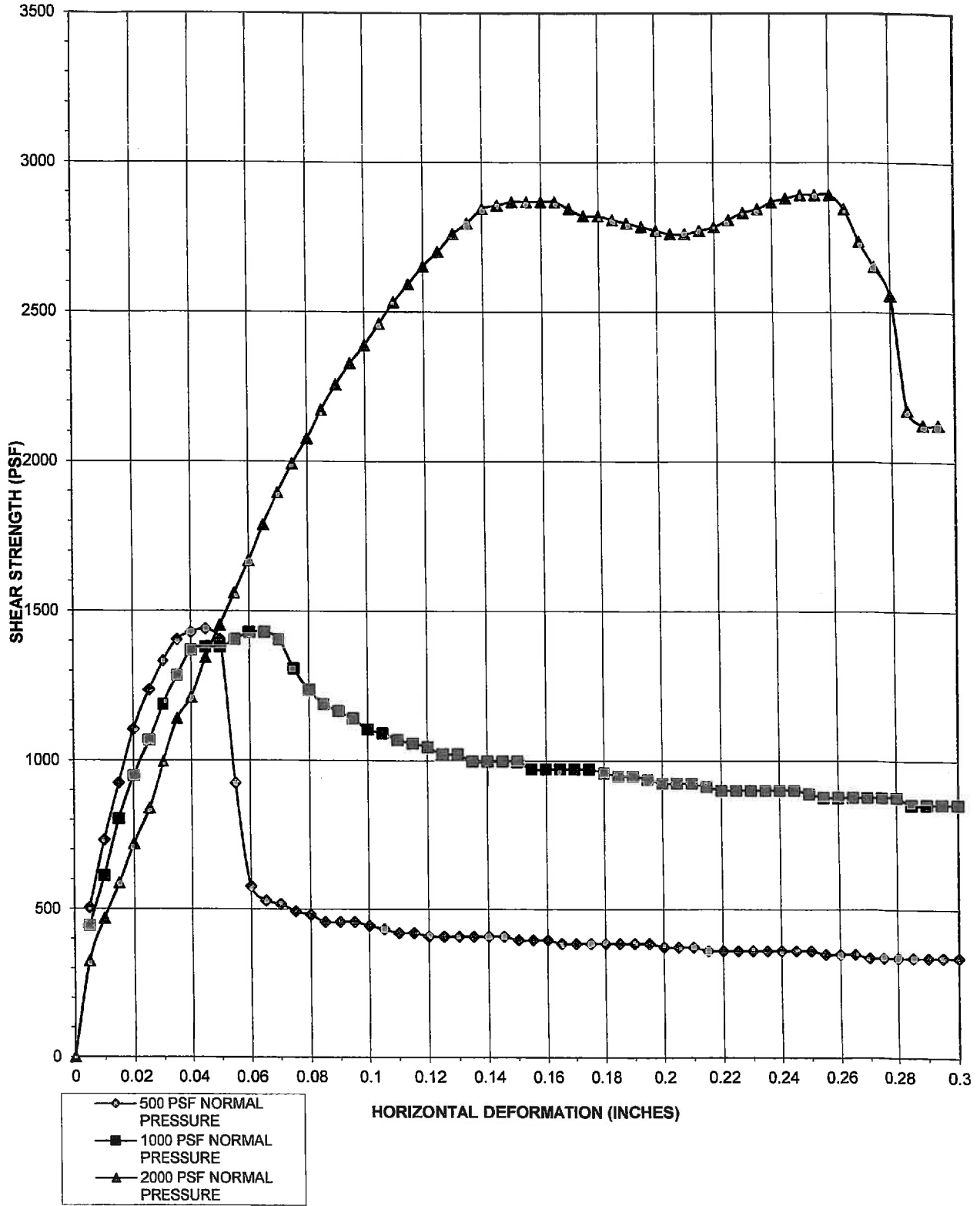

GH: 16870-G
CLIENT: Harvard-Westlake
DATE: 11/2014
SAMPLE ID: GHB-1 @15'

DIRECT SHEAR TEST

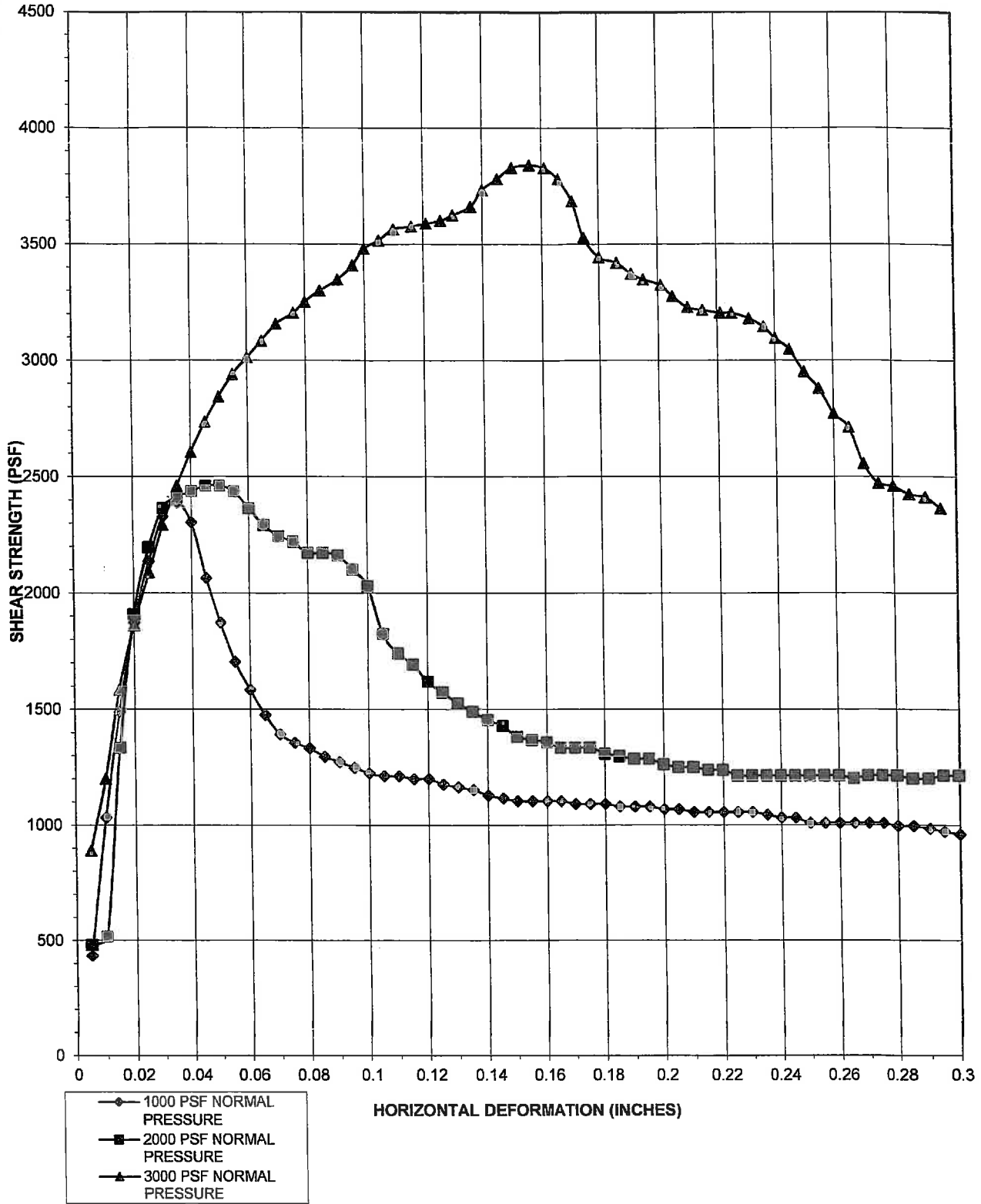

GH: 16870-G
CLIENT: Harvard-Westlake
DATE: 11/2014
SAMPLE ID: GHB-1 @25'

DIRECT SHEAR TEST

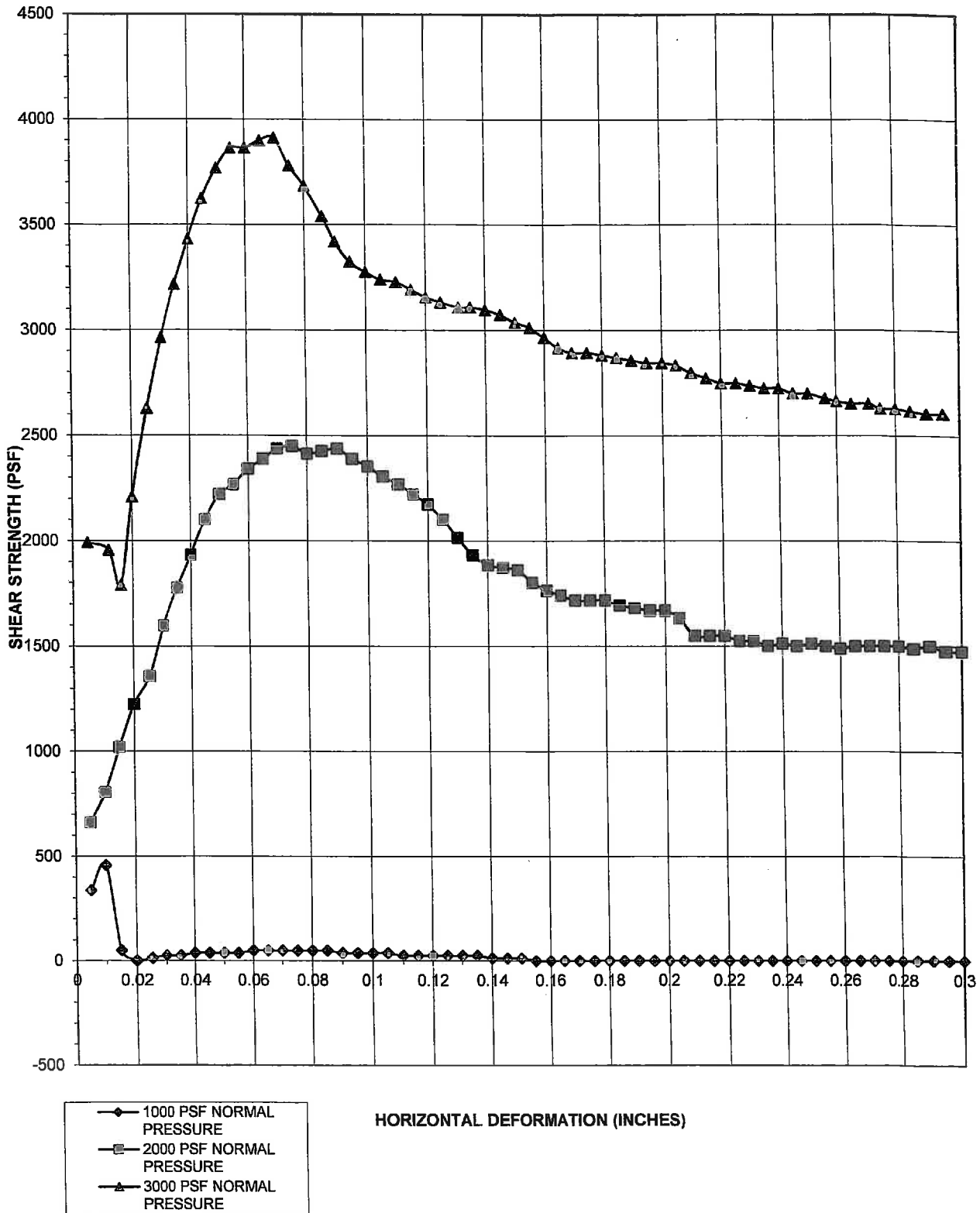

GH: 16870-G
CLIENT: Harvard-Westlake
DATE: 11/2014
SAMPLE ID: GHB-1 @35'

DIRECT SHEAR TEST

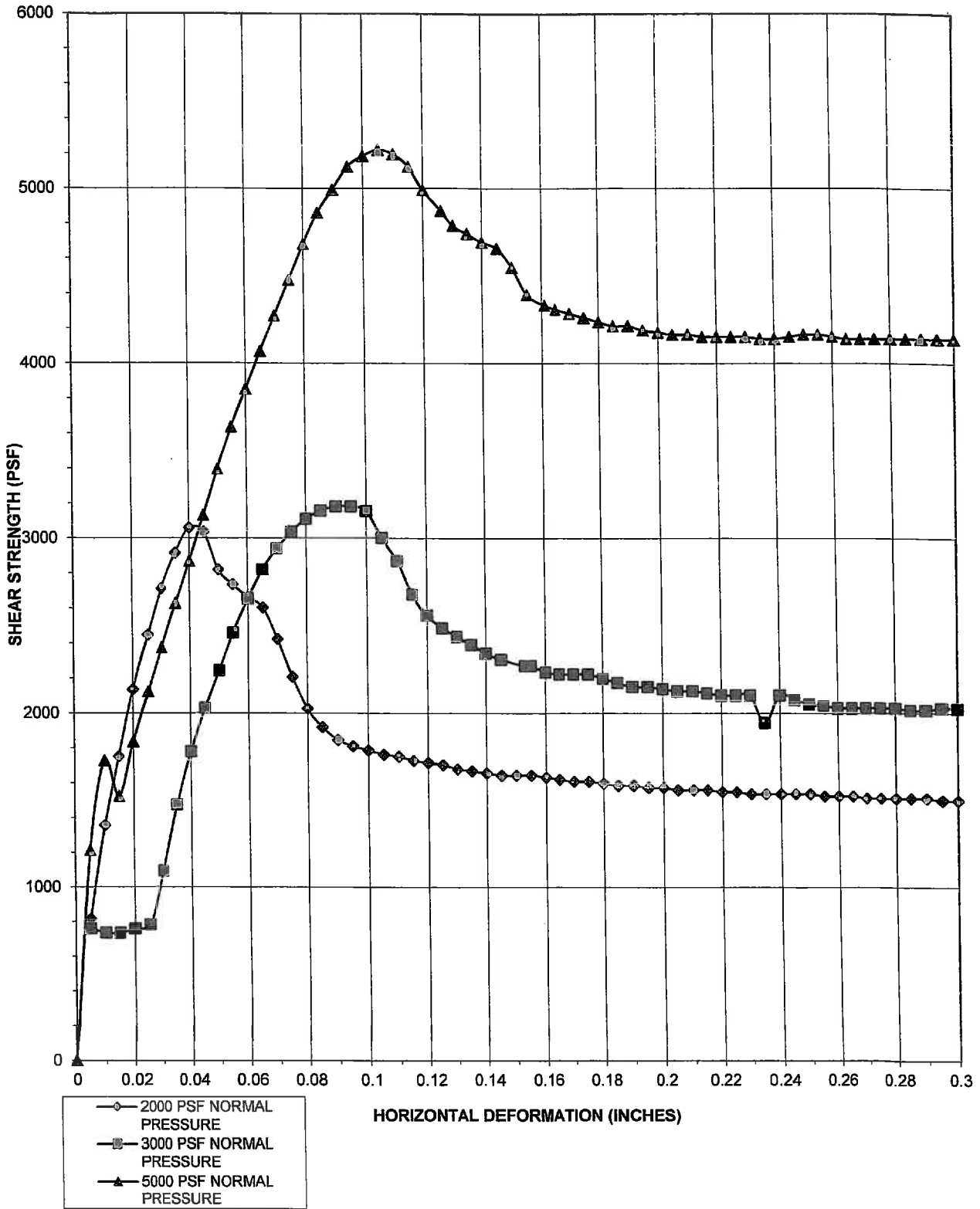

GH: 16870-G
CLIENT: Harvard-Westlake
DATE: 12/2014
SAMPLE ID: GHB-1 @45ft

DIRECT SHEAR TEST

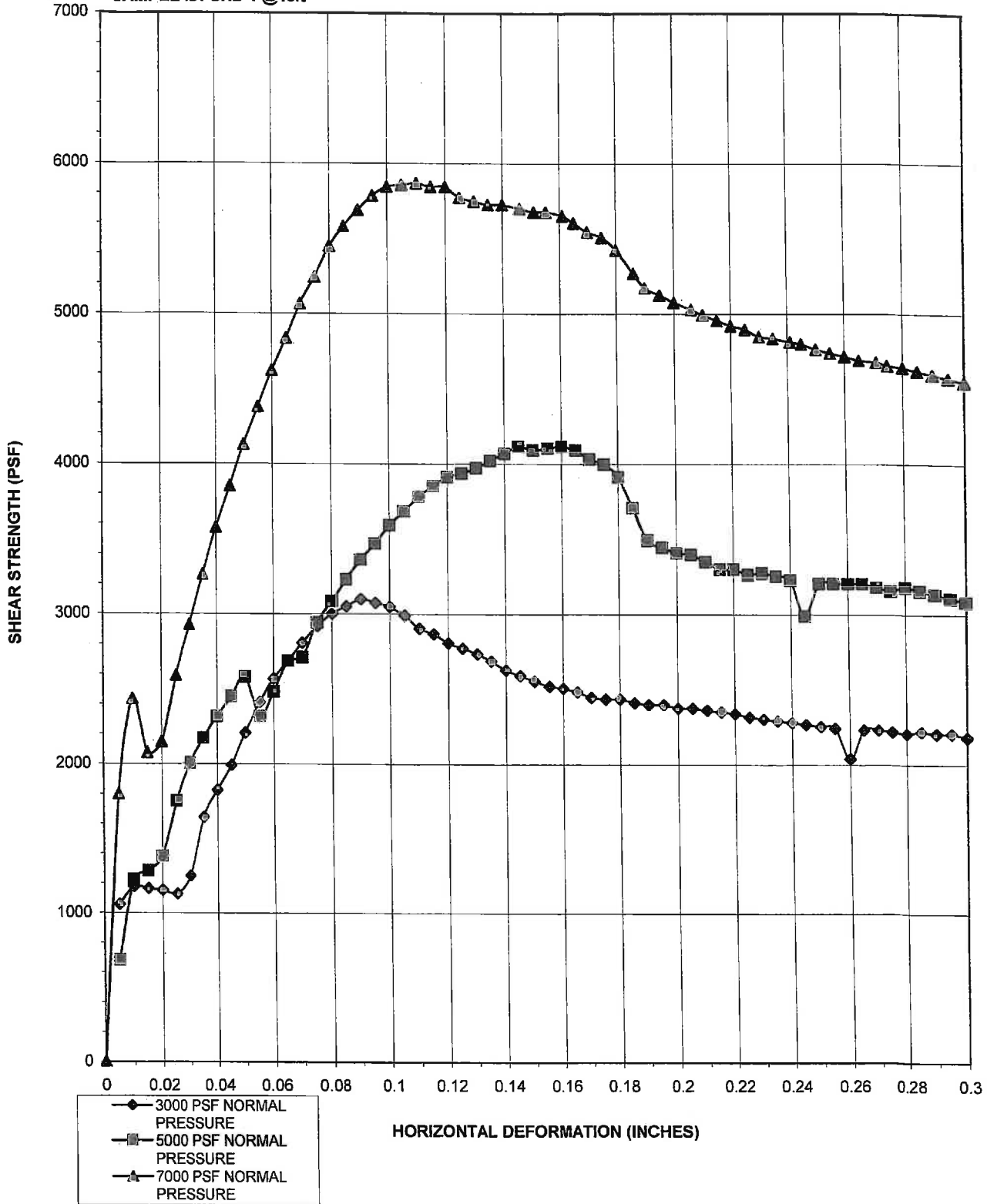

GH: 16870-G
CLIENT: Harvard-Westlake
DATE: 11/2014
SAMPLE ID: GHB-1 @50'
(Cut-Rock)

DIRECT SHEAR TEST

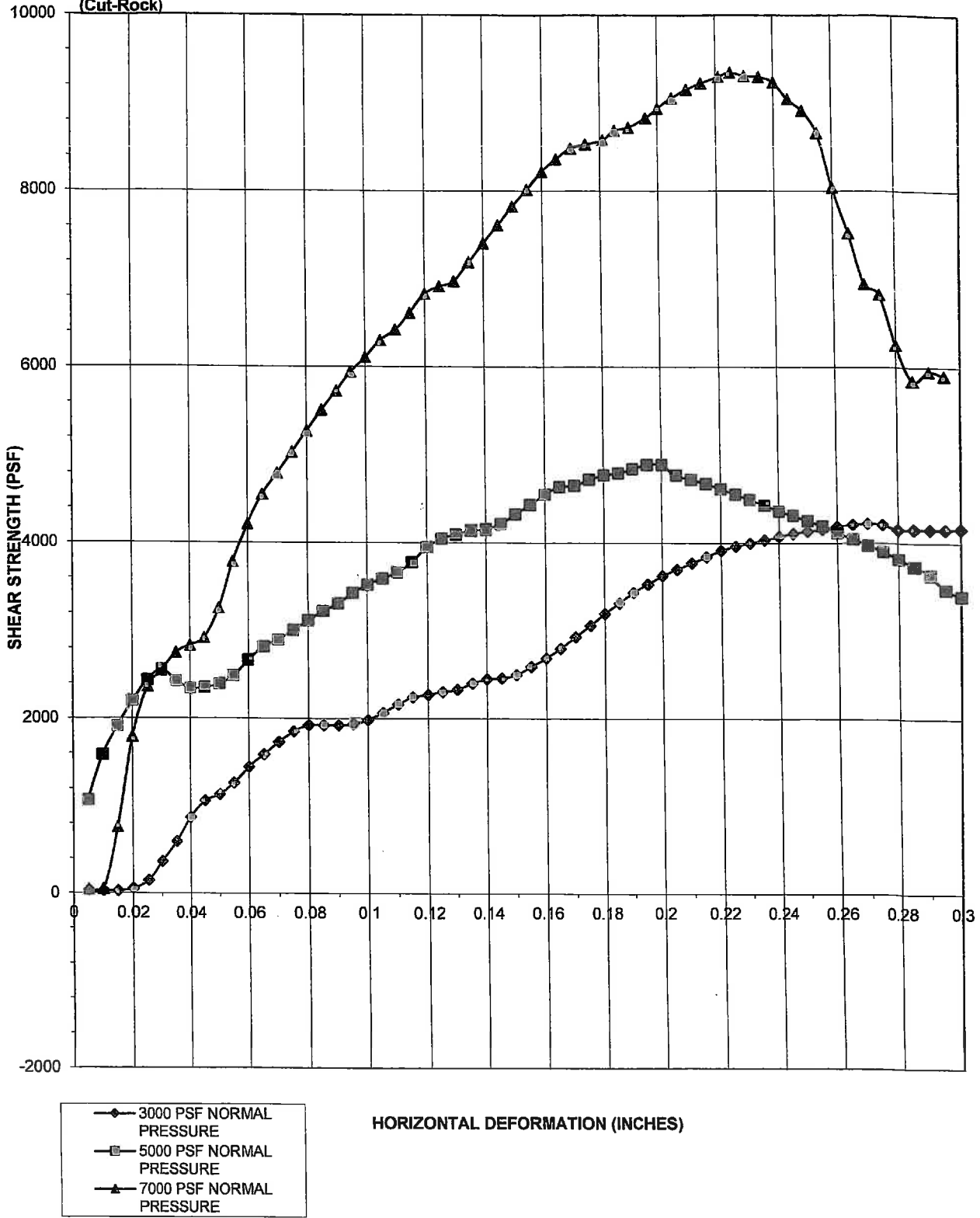

GH: 16870-G
CLIENT: Harvard-Westlake
DATE: 11/2014
SAMPLE ID: GHB-1 @52'

DIRECT SHEAR TEST

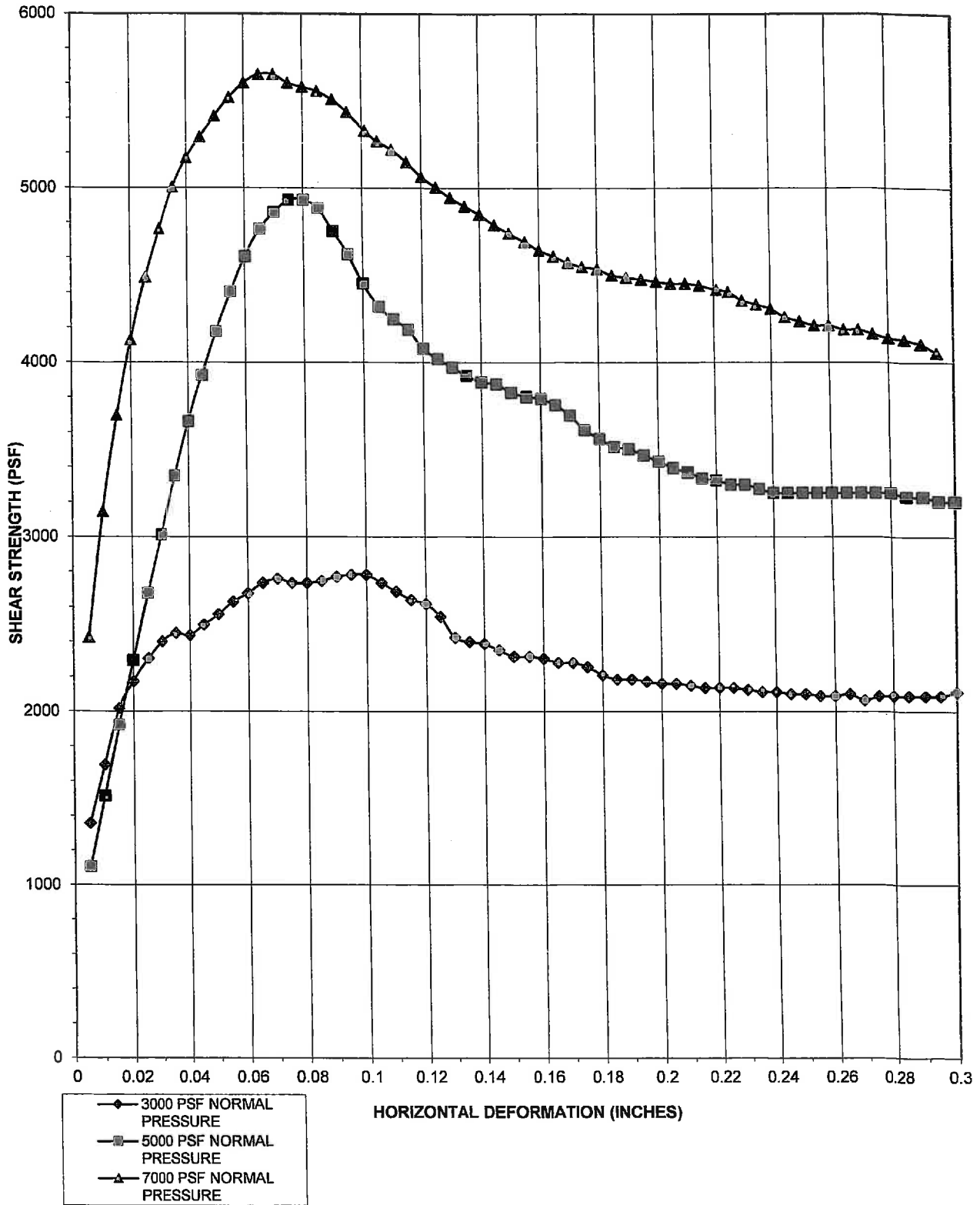

GH: 16870-G
CLIENT: Harvard-Westlake
DATE: 12/2014
SAMPLE ID: GHB-2 @10ft

DIRECT SHEAR TEST

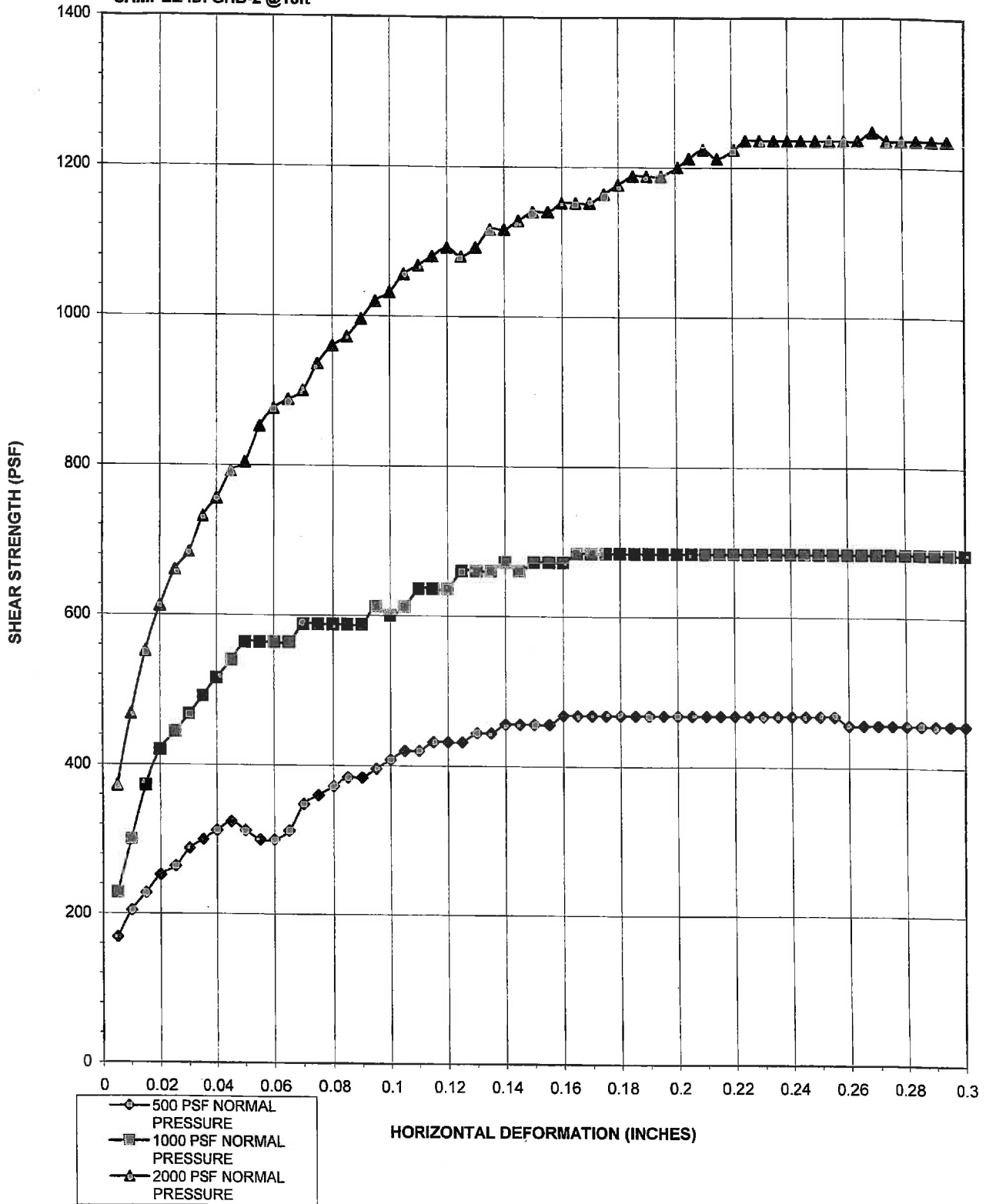

GH: 16870-G
CLIENT: Harvard-Westlake
DATE: 11/2014
SAMPLE ID: GHB-2 @20'

DIRECT SHEAR TEST

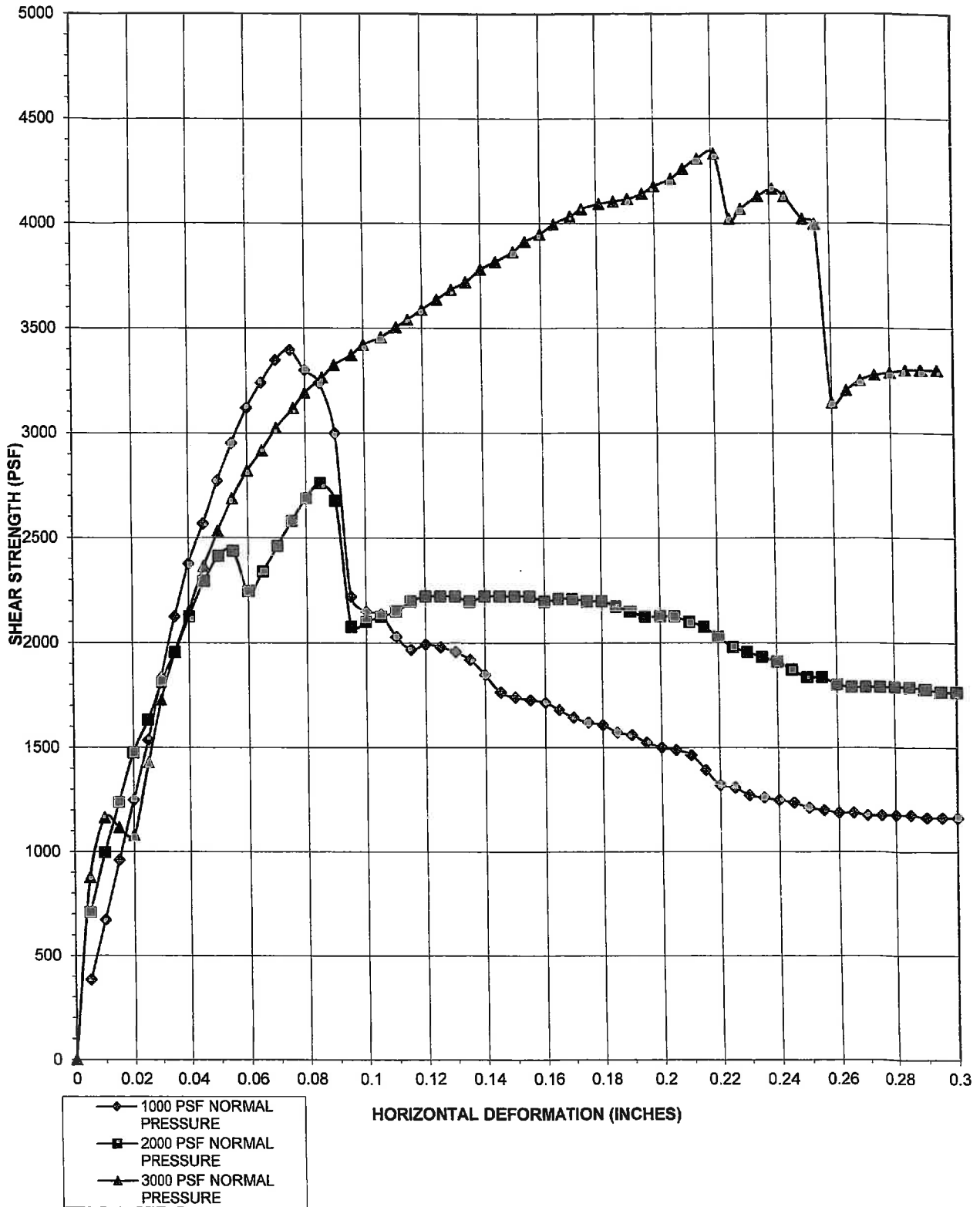

GH: 16870-G
CLIENT: Harvard-Westlake
DATE: 11/2014
SAMPLE ID: GHB-2 @30'

DIRECT SHEAR TEST

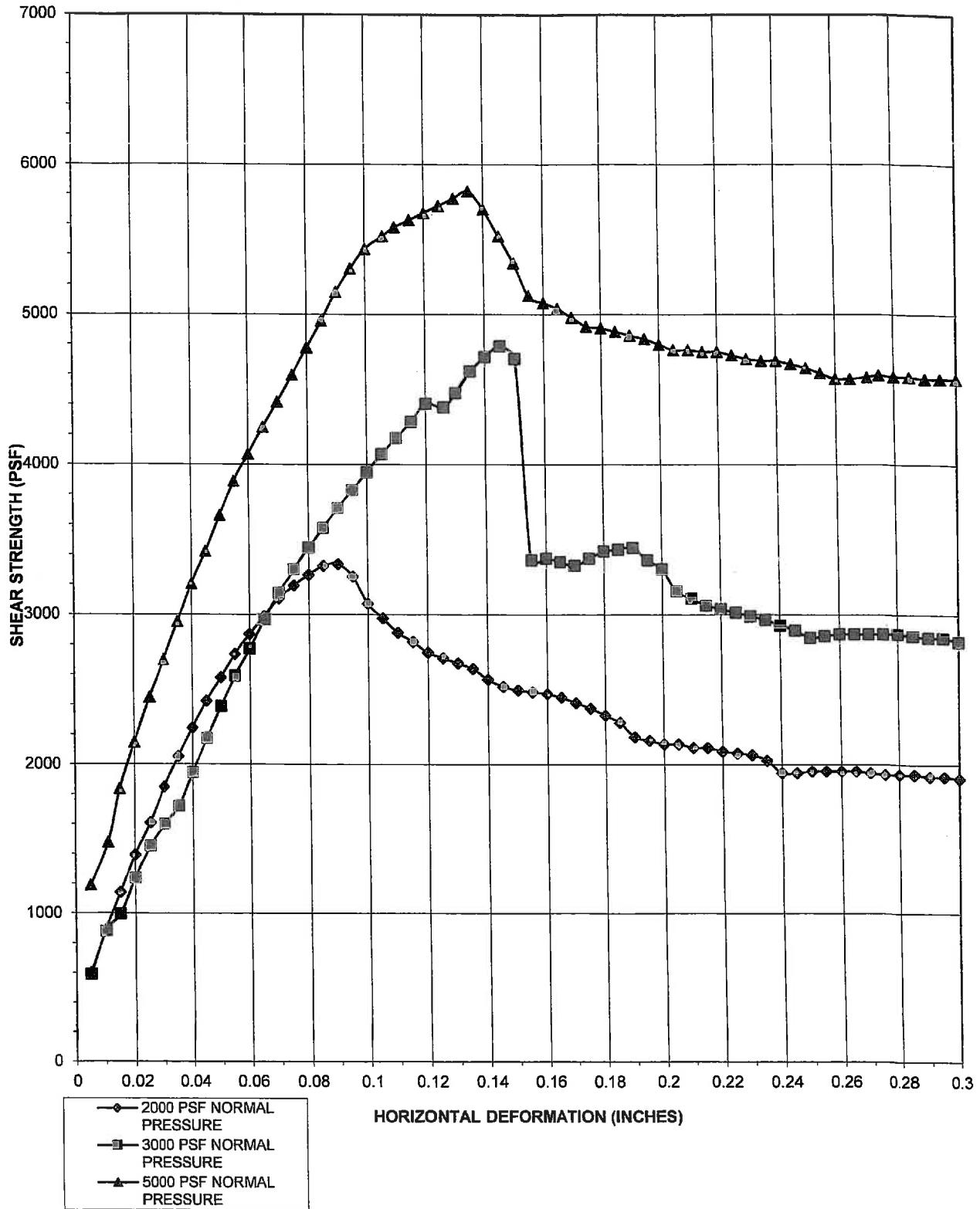

GH: 16870-G
CLIENT: Harvard-Westlake
DATE: 12/2014
SAMPLE ID: GHB-2 @35ft

DIRECT SHEAR TEST

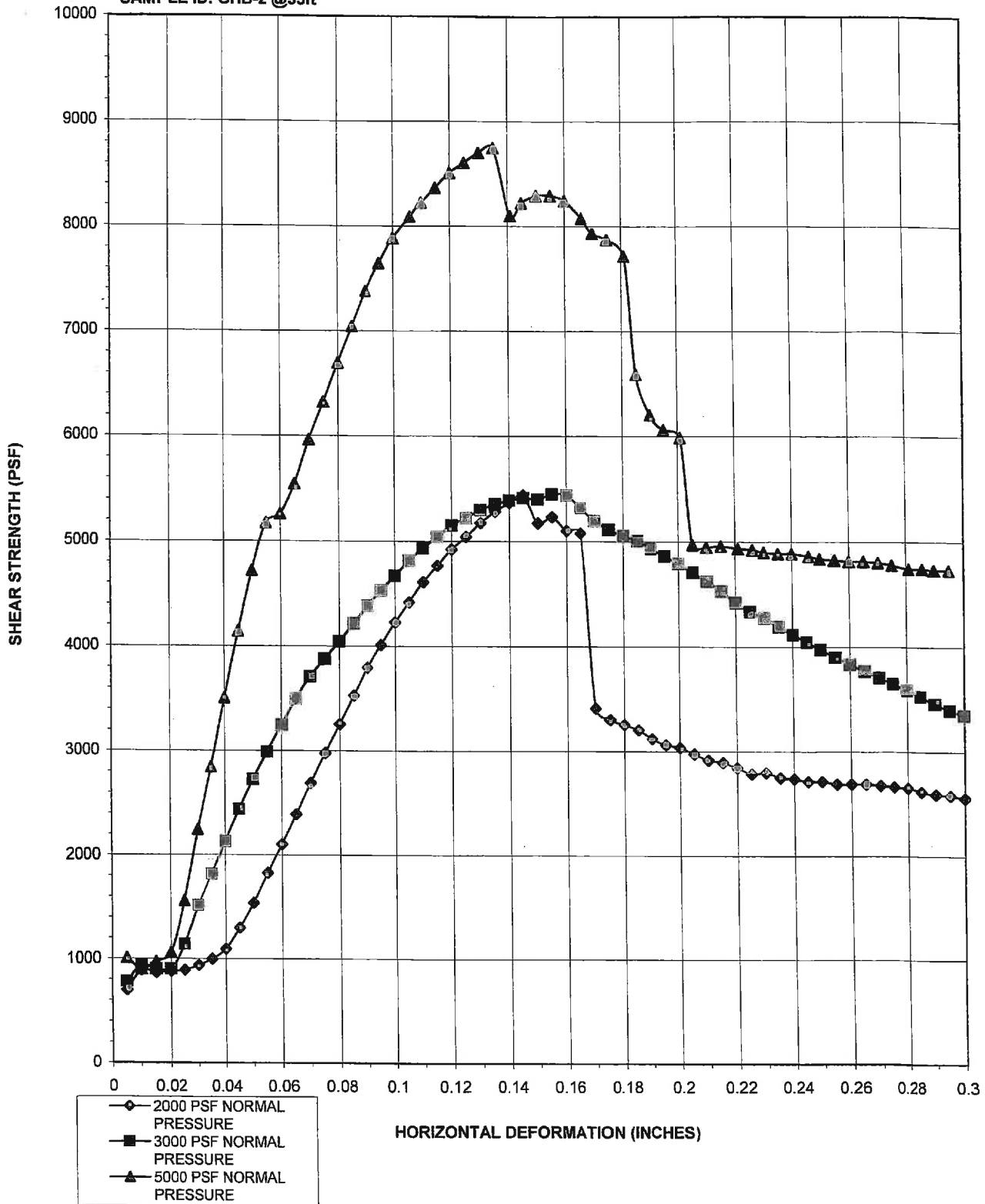

GH: 16870-G
CLIENT: Harvard-Westlake
DATE: 11/2014
SAMPLE ID: GHB-2 @50'

DIRECT SHEAR TEST

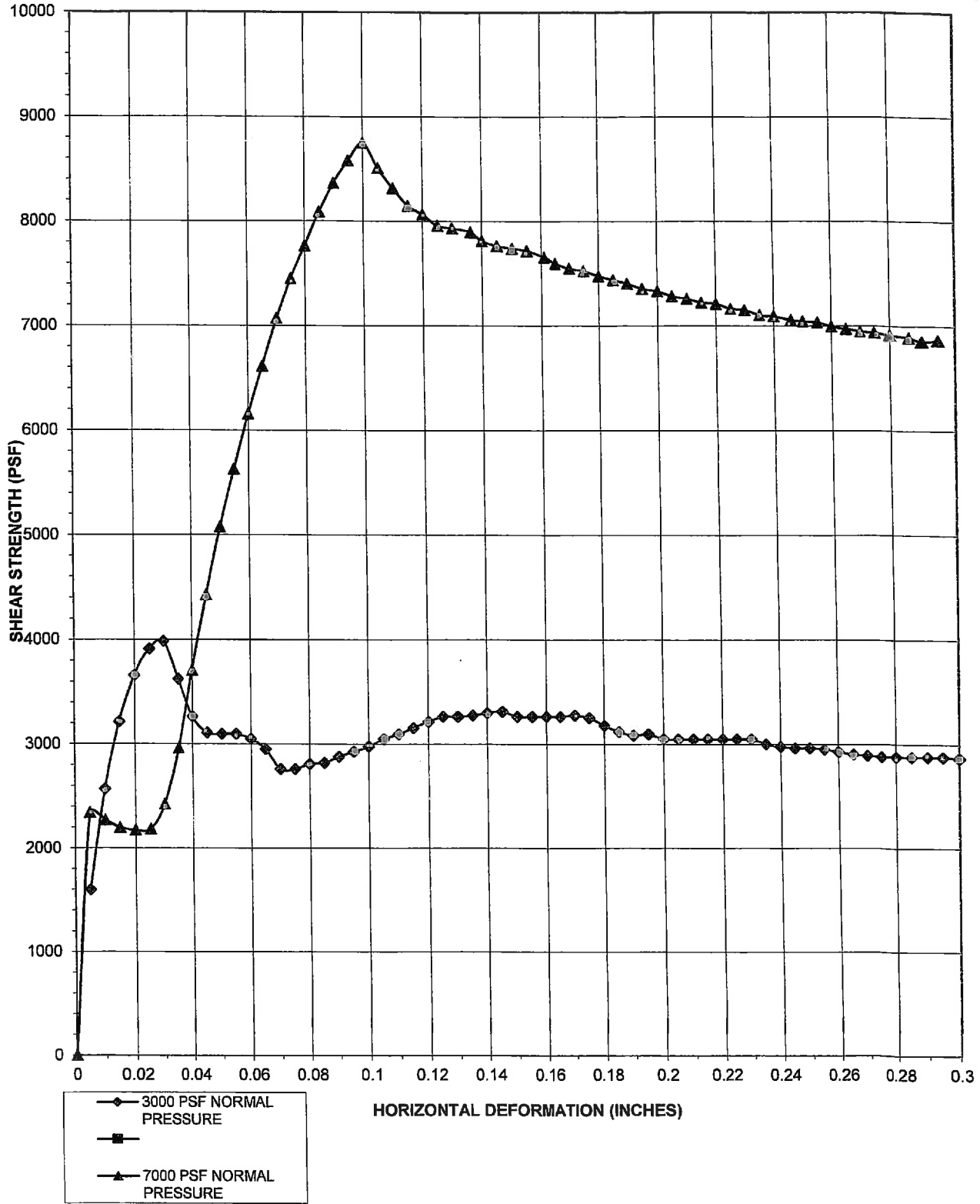

GH: 16870-G
CLIENT: Harvard-Westlake
DATE: 12/2014
SAMPLE ID: GHB-2 @60ft

DIRECT SHEAR TEST

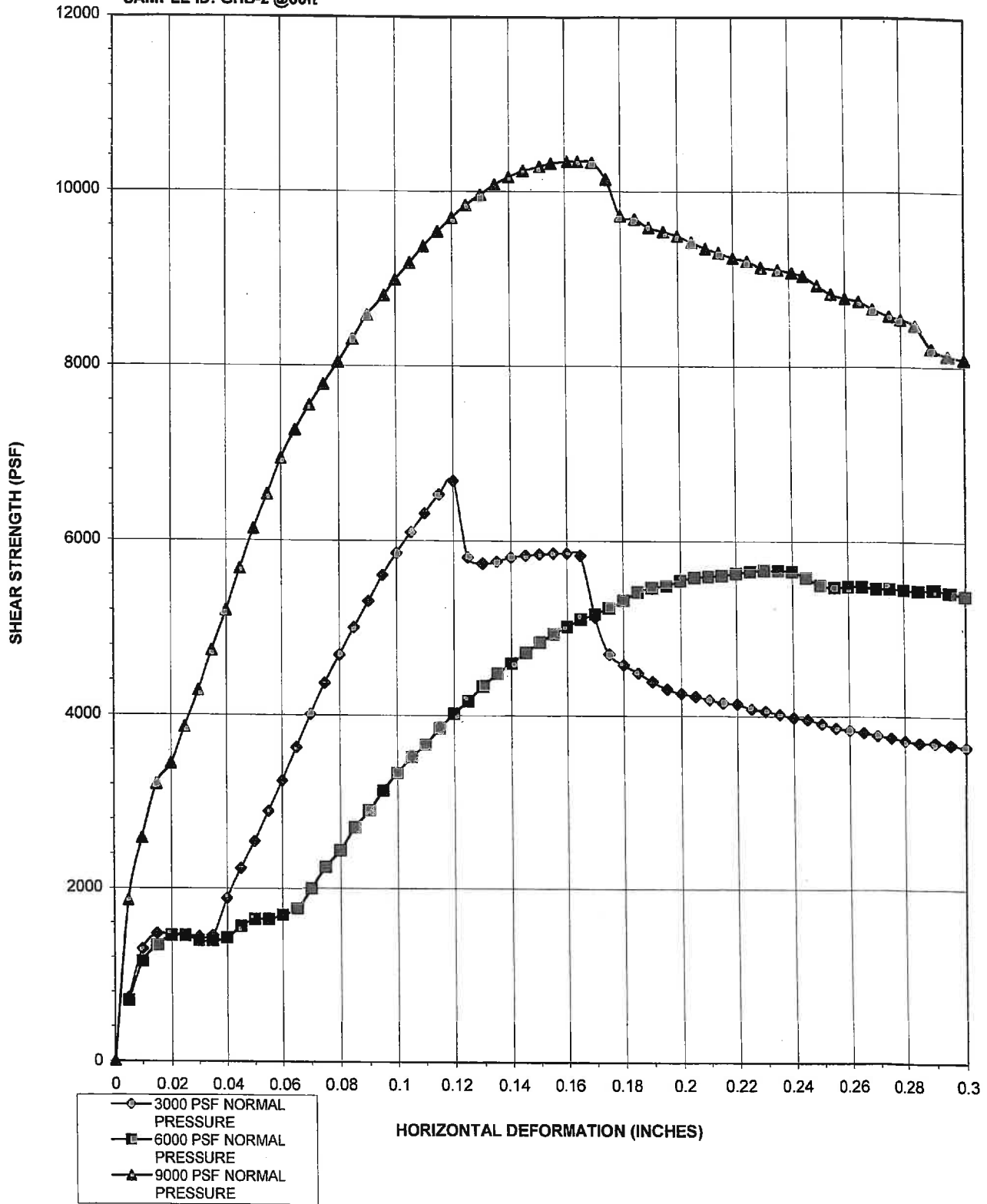

GH: 16870-G
CLIENT: Harvard-Westlake
DATE: 11/2014
SAMPLE ID: GHB-2 @70

DIRECT SHEAR TEST

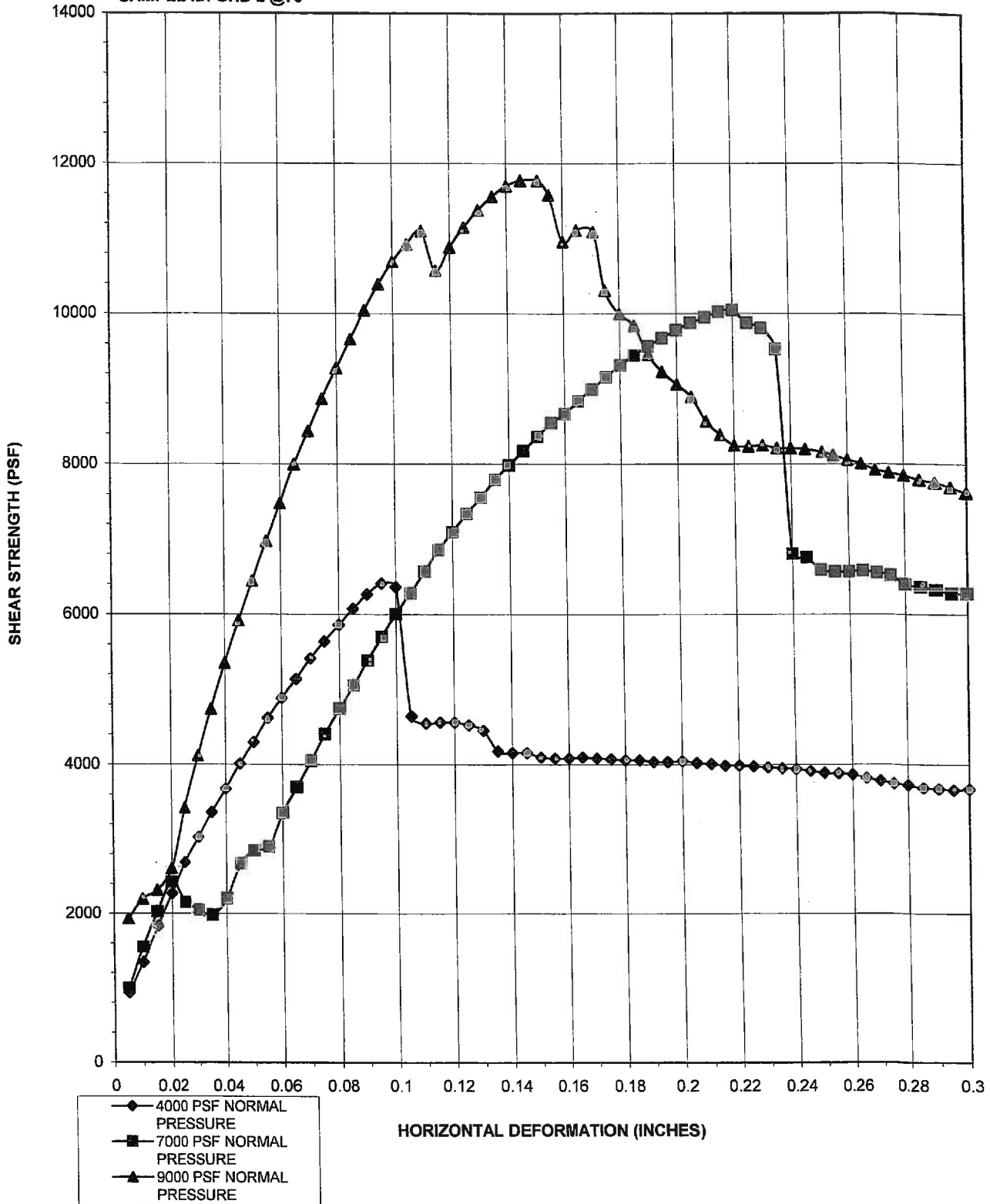

GH: 16870-G
CLIENT: Harvard-Westlake
DATE: 11/2014
SAMPLE ID: GHB-3 @11'

DIRECT SHEAR TEST

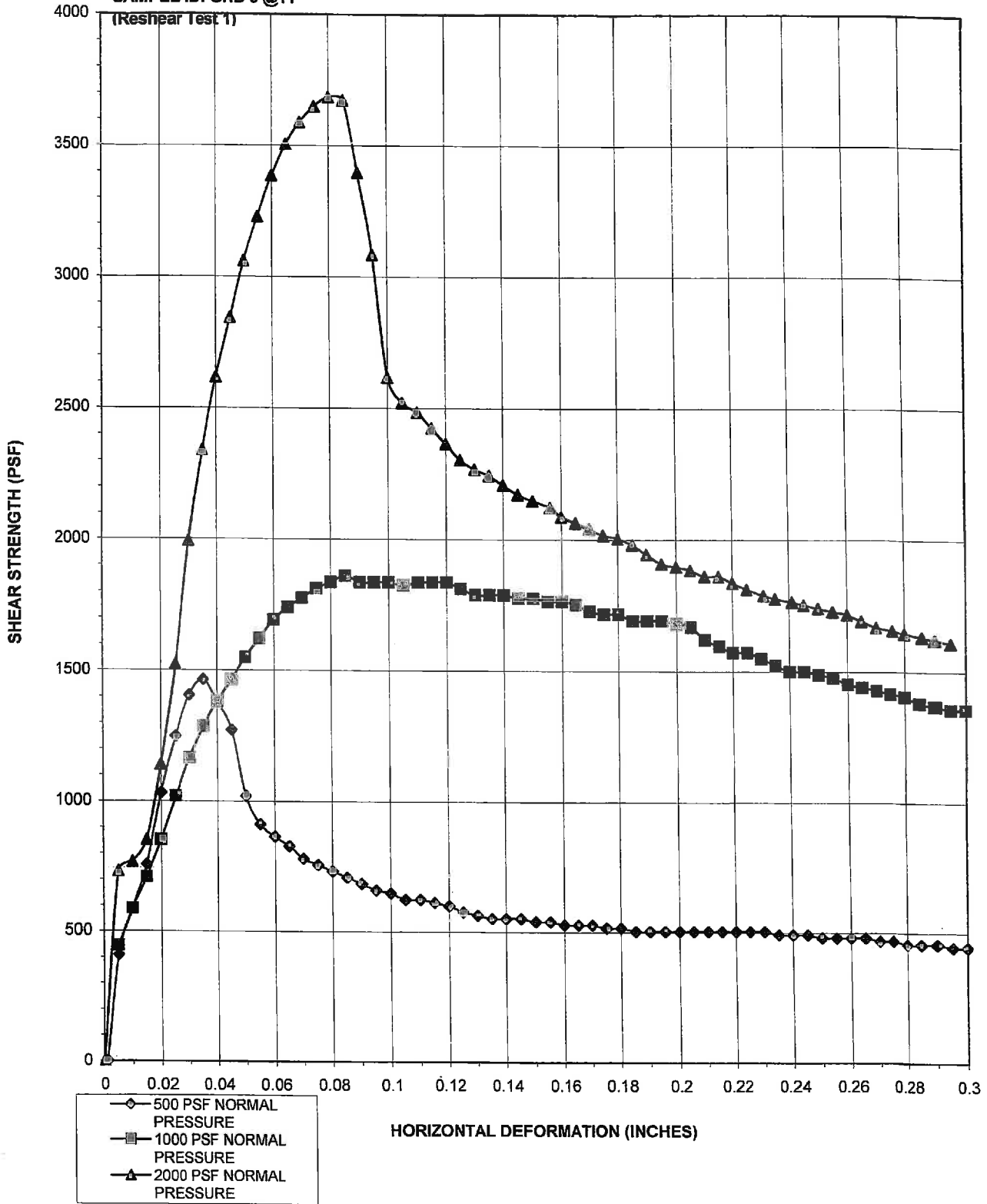

GH: 16870-G
CLIENT: Harvard-Westlake
DATE: 11/2014
SAMPLE ID: GHB-3 @11'

DIRECT SHEAR TEST

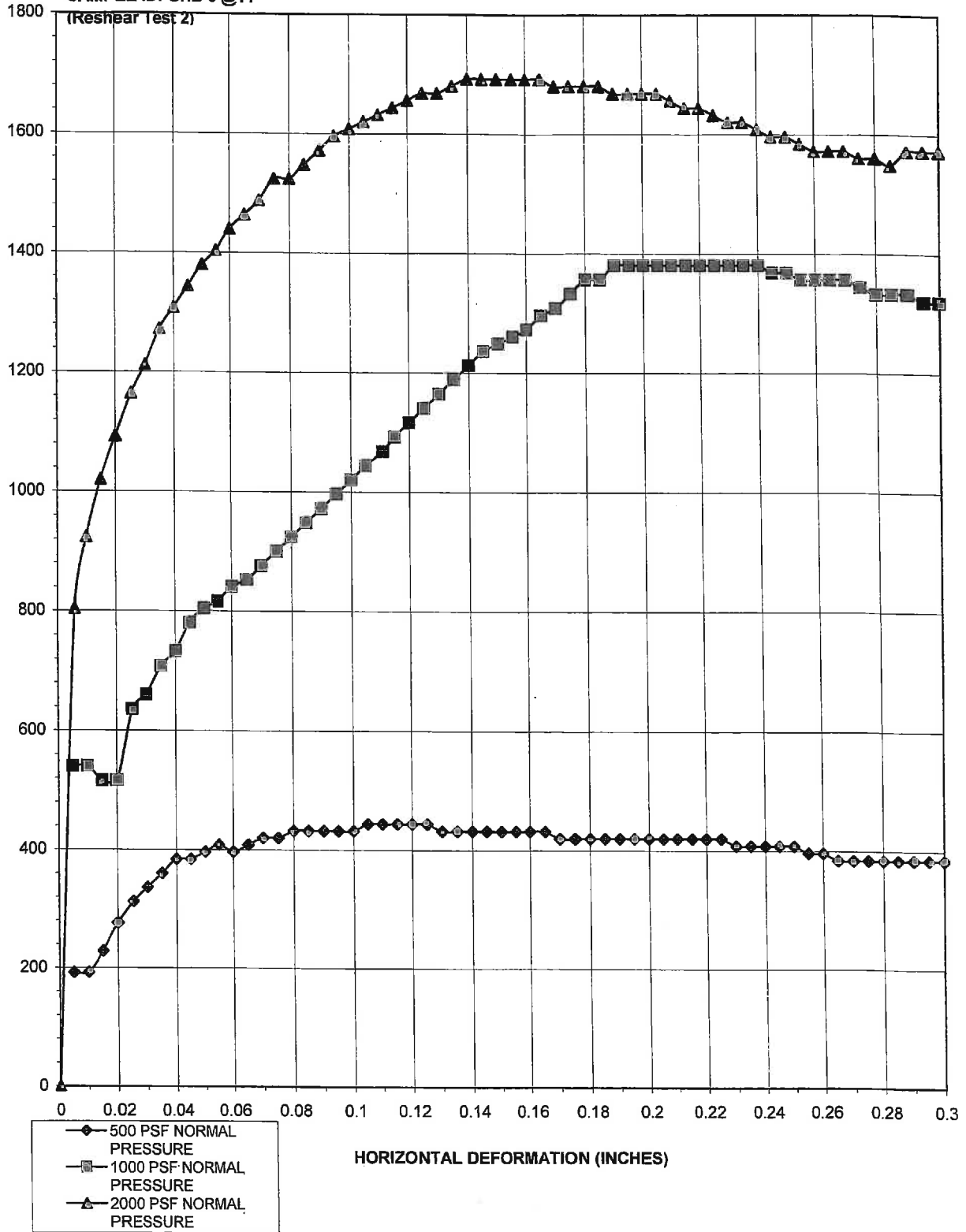

GH: 16870-G
CLIENT: Harvard-Westlake
DATE: 11/2014
SAMPLE ID: GHB-3 @20

DIRECT SHEAR TEST

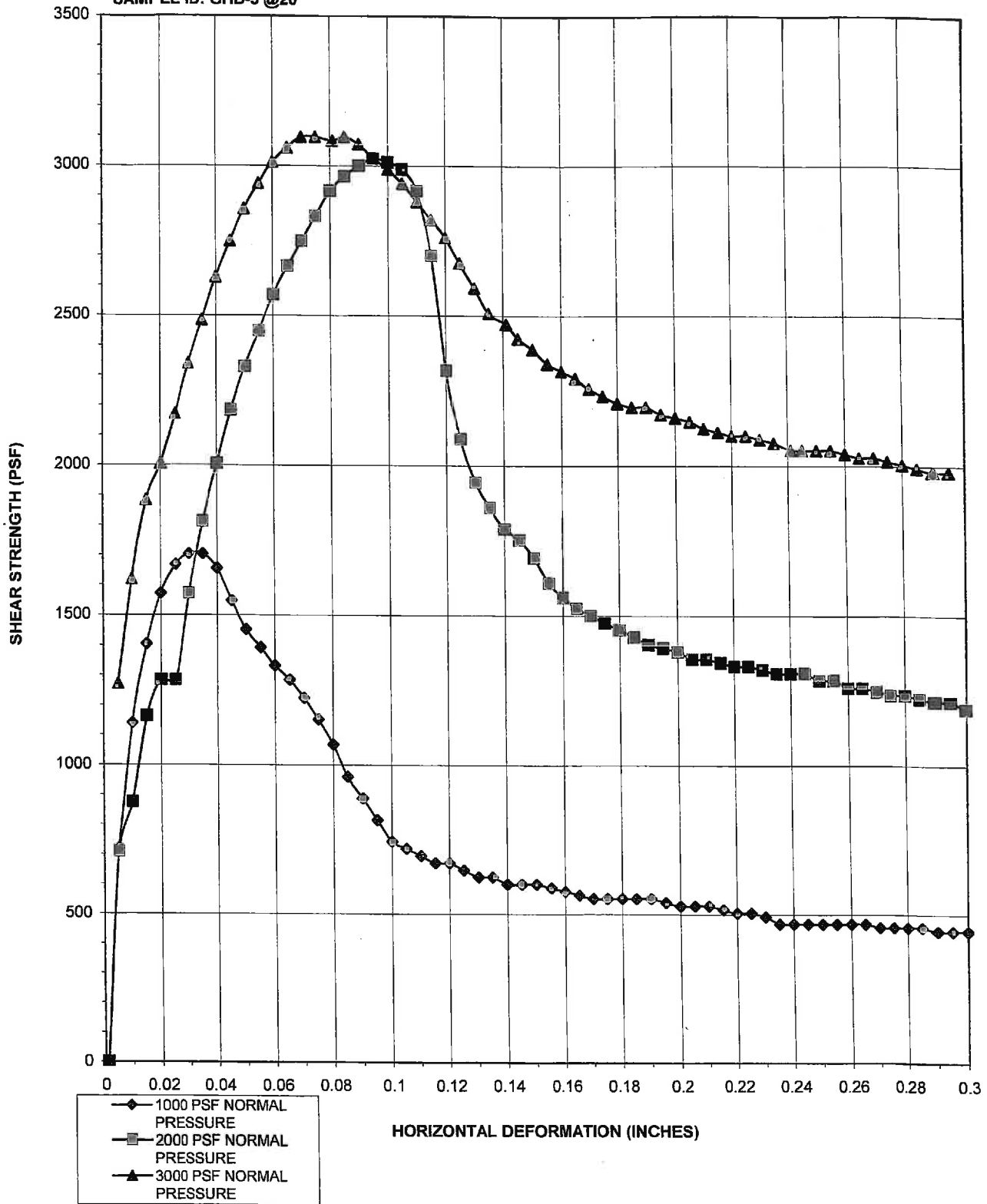

GH: 16870-G
CLIENT: Harvard-Westlake
DATE: 11/2014
SAMPLE ID: GHB-3 @23.5'
(Remold, Test 1)

DIRECT SHEAR TEST

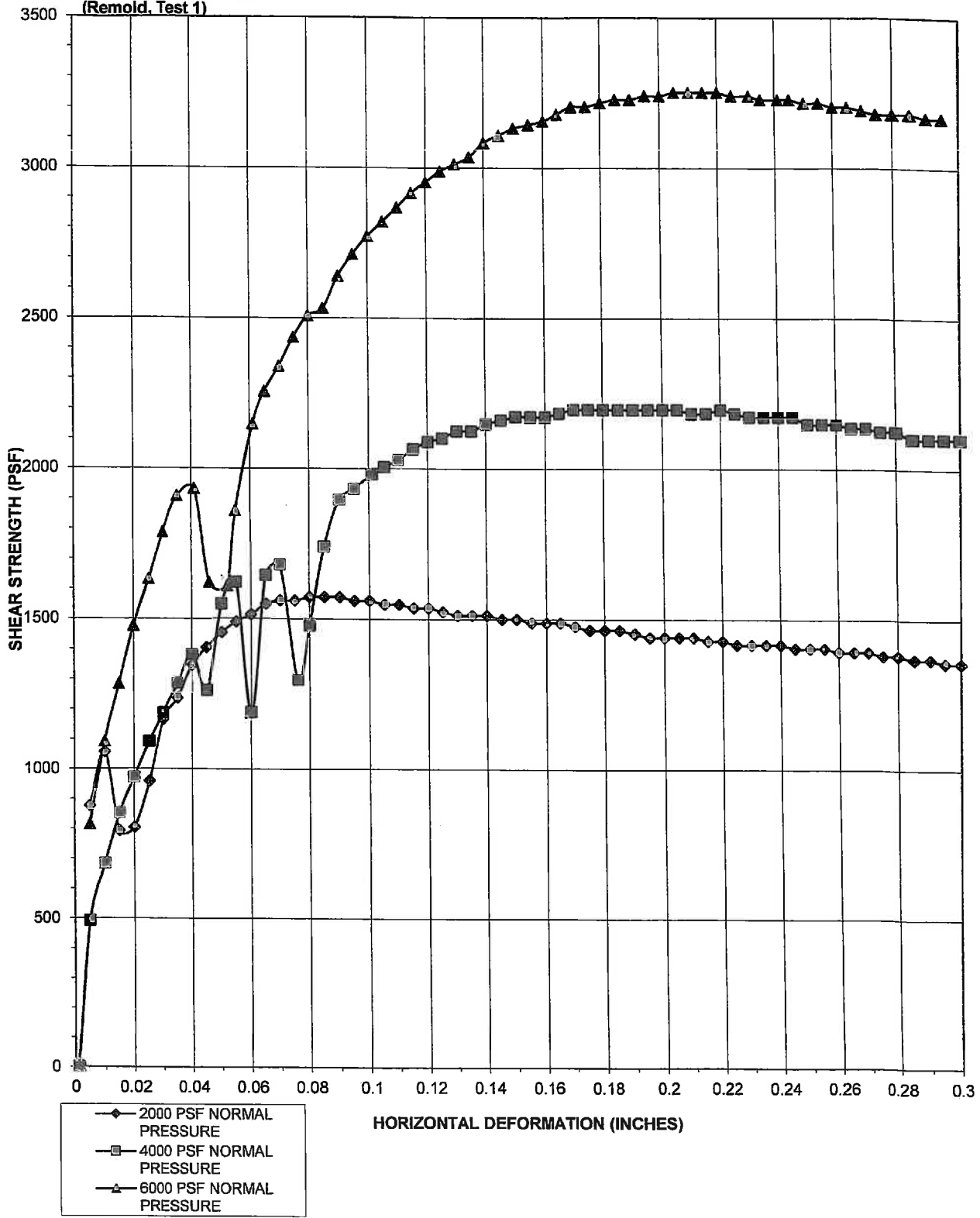

GH: 16870-G
CLIENT: Harvard-Westlake
DATE: 11/2014
SAMPLE ID: GHB-3 @23.5'
(Remold, Test 2)

DIRECT SHEAR TEST

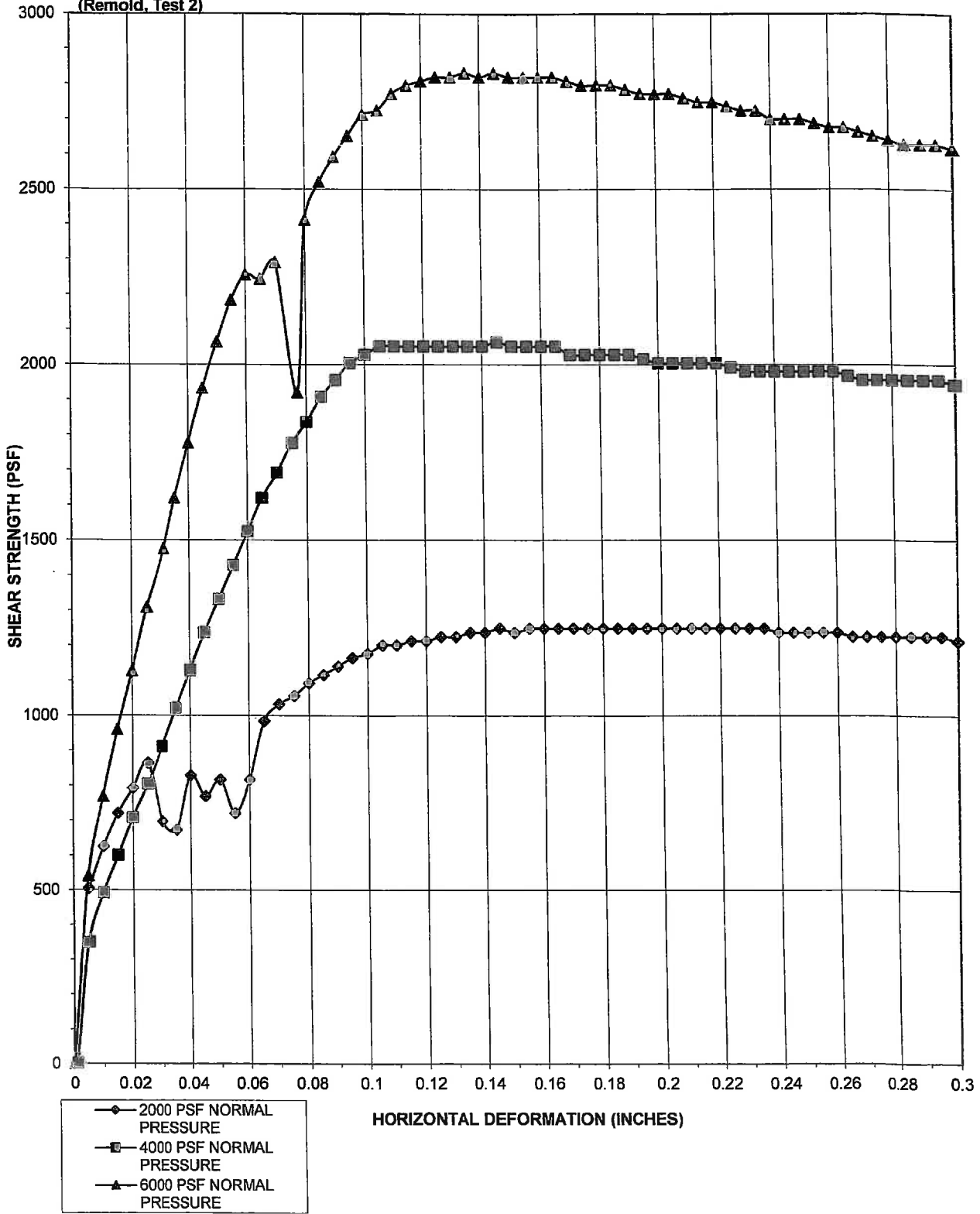

GH: 16870-G
CLIENT: Harvard-Westlake
DATE: 11/2014
SAMPLE ID: GHB-3 @25'

DIRECT SHEAR TEST

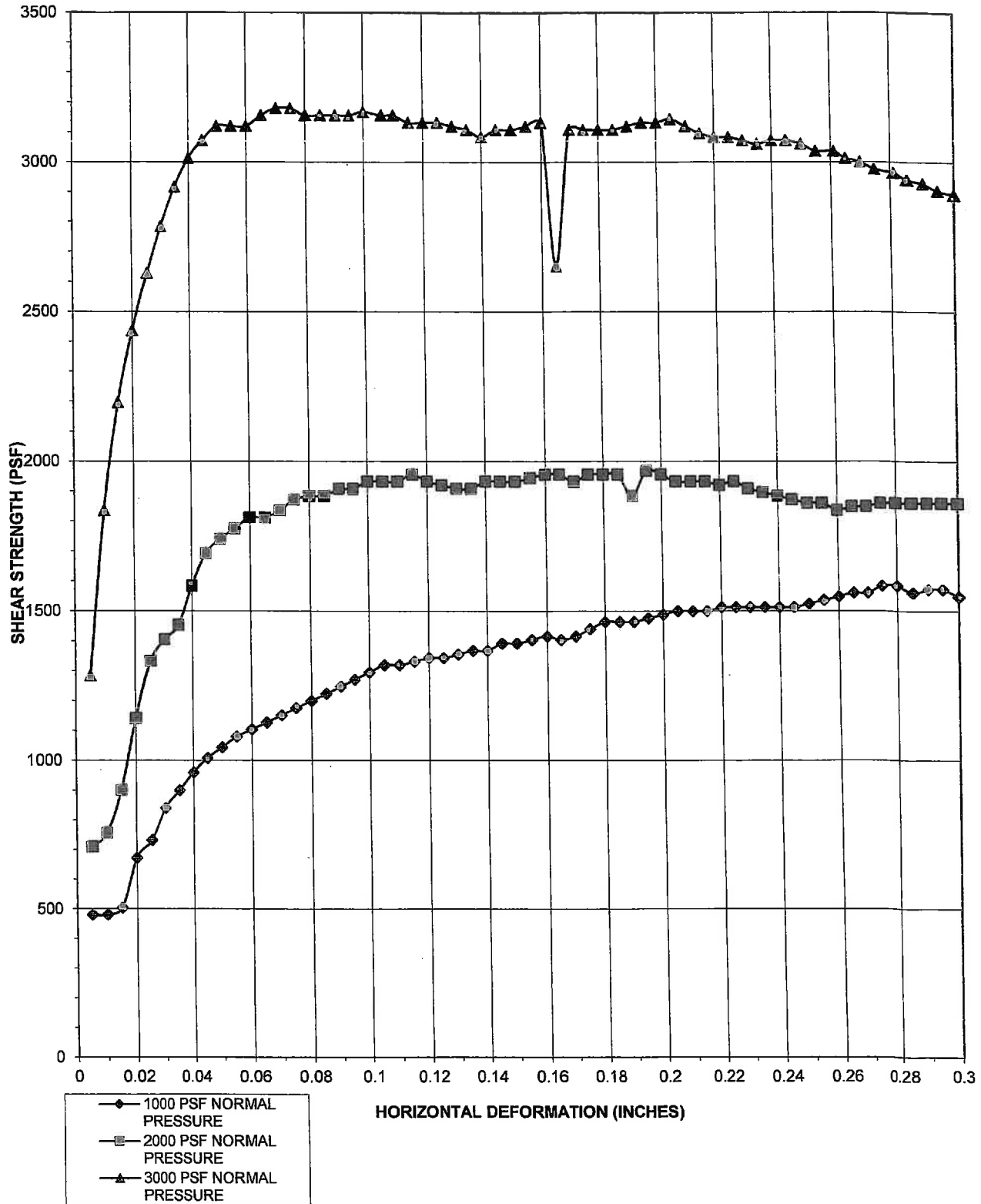

GH: 16870-G
CLIENT: Harvard-Westlake
DATE: 12/2014
SAMPLE ID: GHB-3 @30ft

DIRECT SHEAR TEST

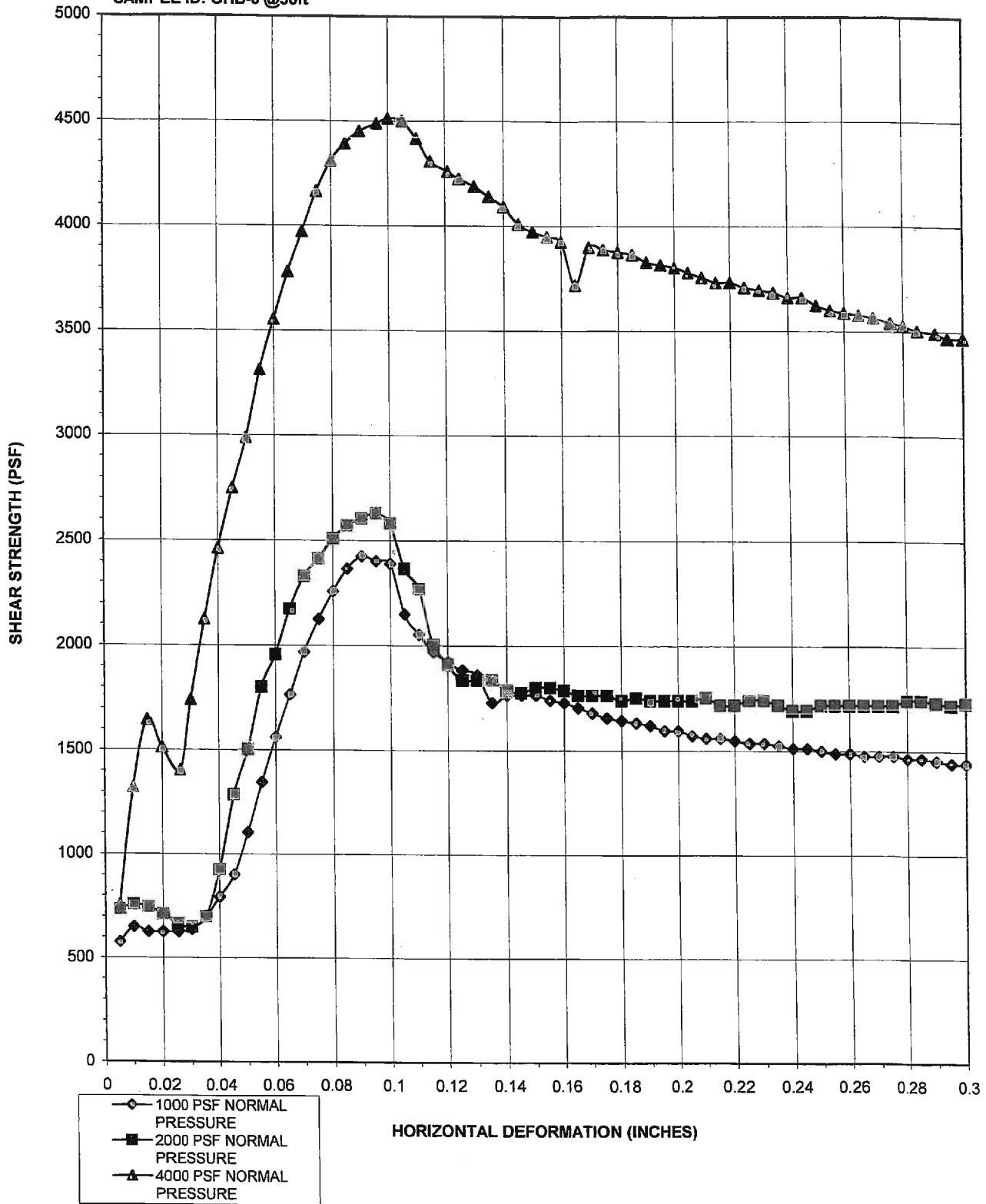

GH: 16870-G
CLIENT: Harvard-Westlake
DATE: 11/2014
SAMPLE ID: GHB-3 @35'

DIRECT SHEAR TEST

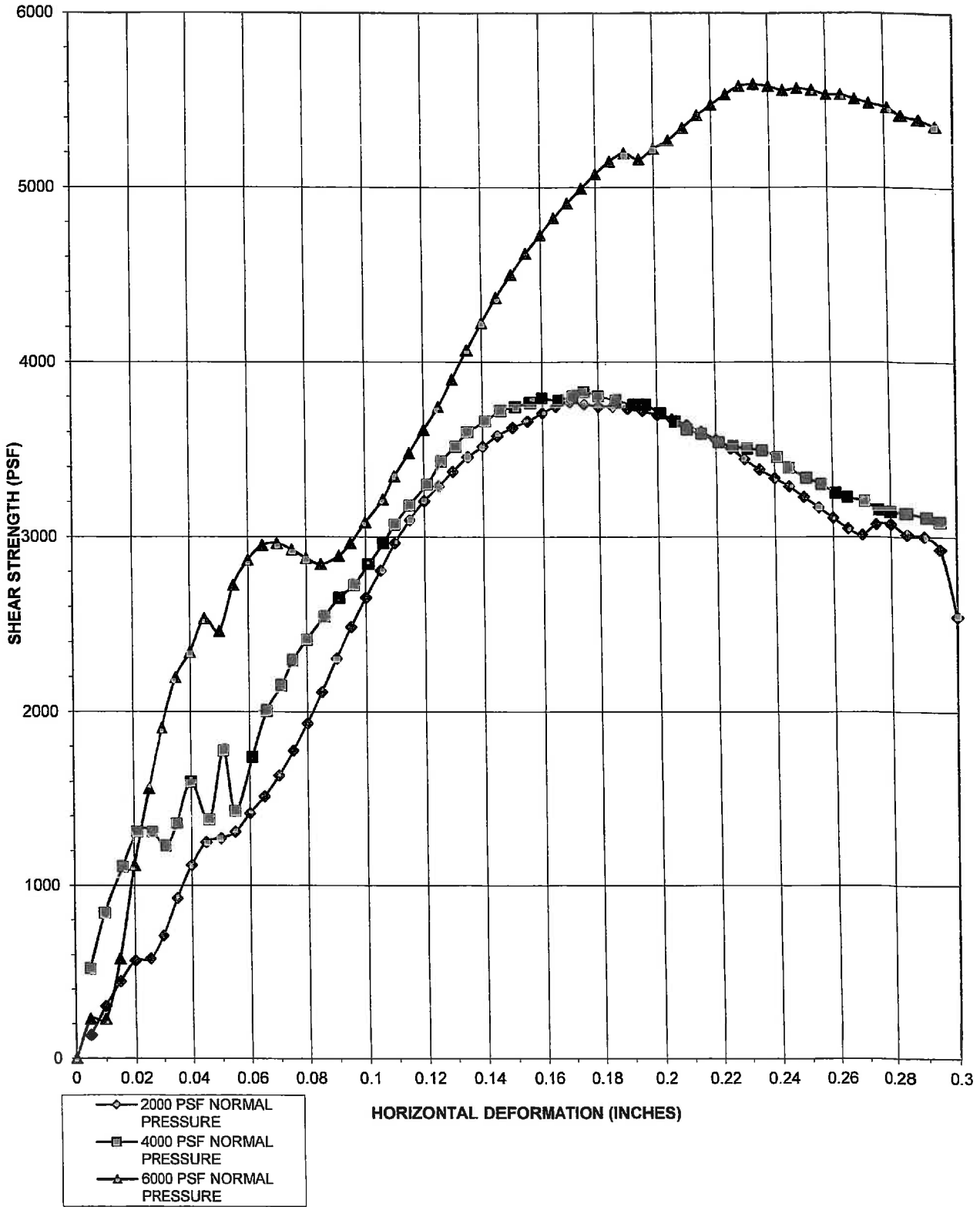

GH: 16870-G
CLIENT: Harvard-Westlake
DATE: 11/2014
SAMPLE ID: GHB-3 @40'

DIRECT SHEAR TEST

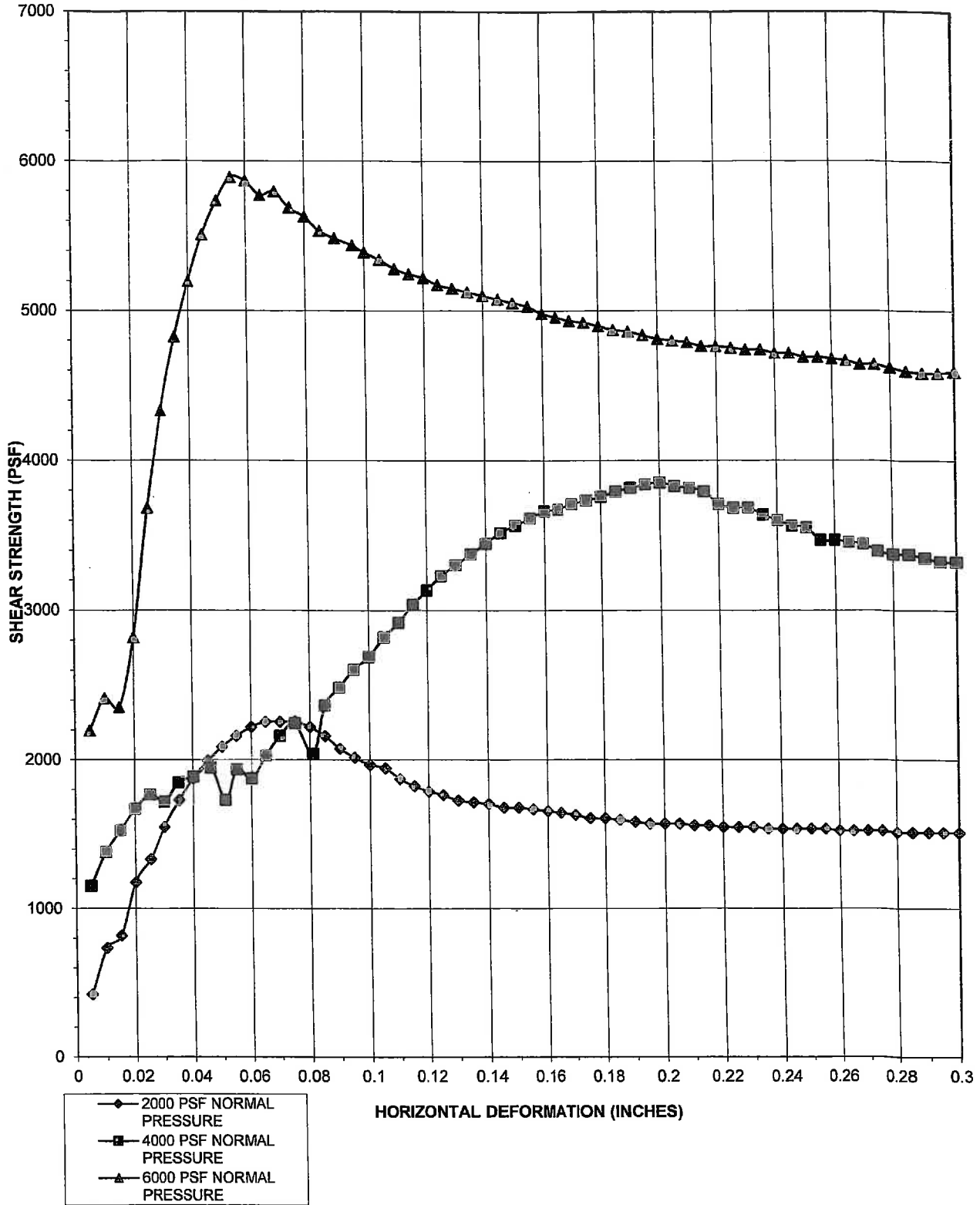

GH: 16870-G
CLIENT: Harvard-Westlake
DATE: 11/2014
SAMPLE ID: GHB-4 @15'

DIRECT SHEAR TEST

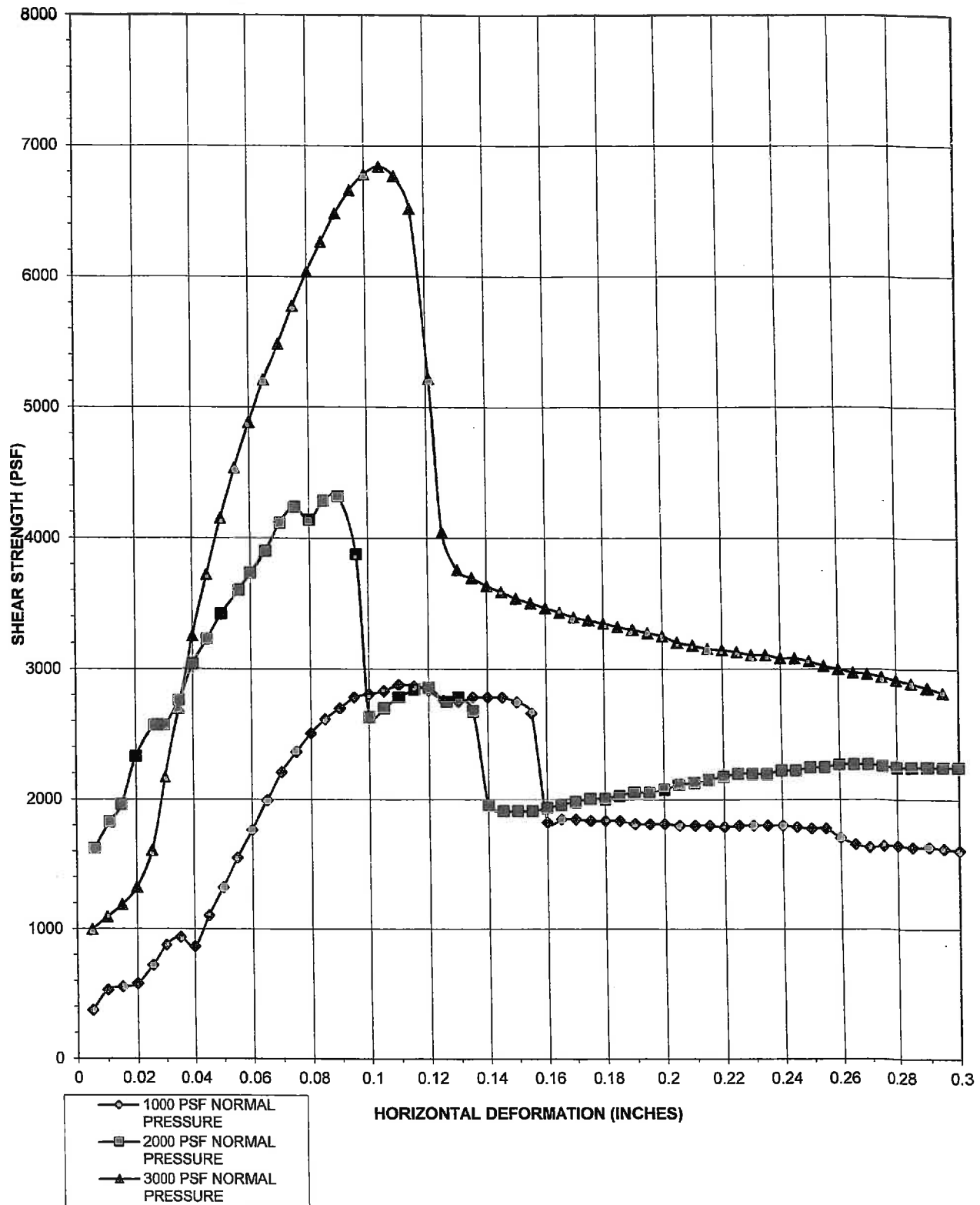

GH: 16870-G
CLIENT: Harvard-Westlake
DATE: 11/2014
SAMPLE ID: GHB-4 @35'

DIRECT SHEAR TEST

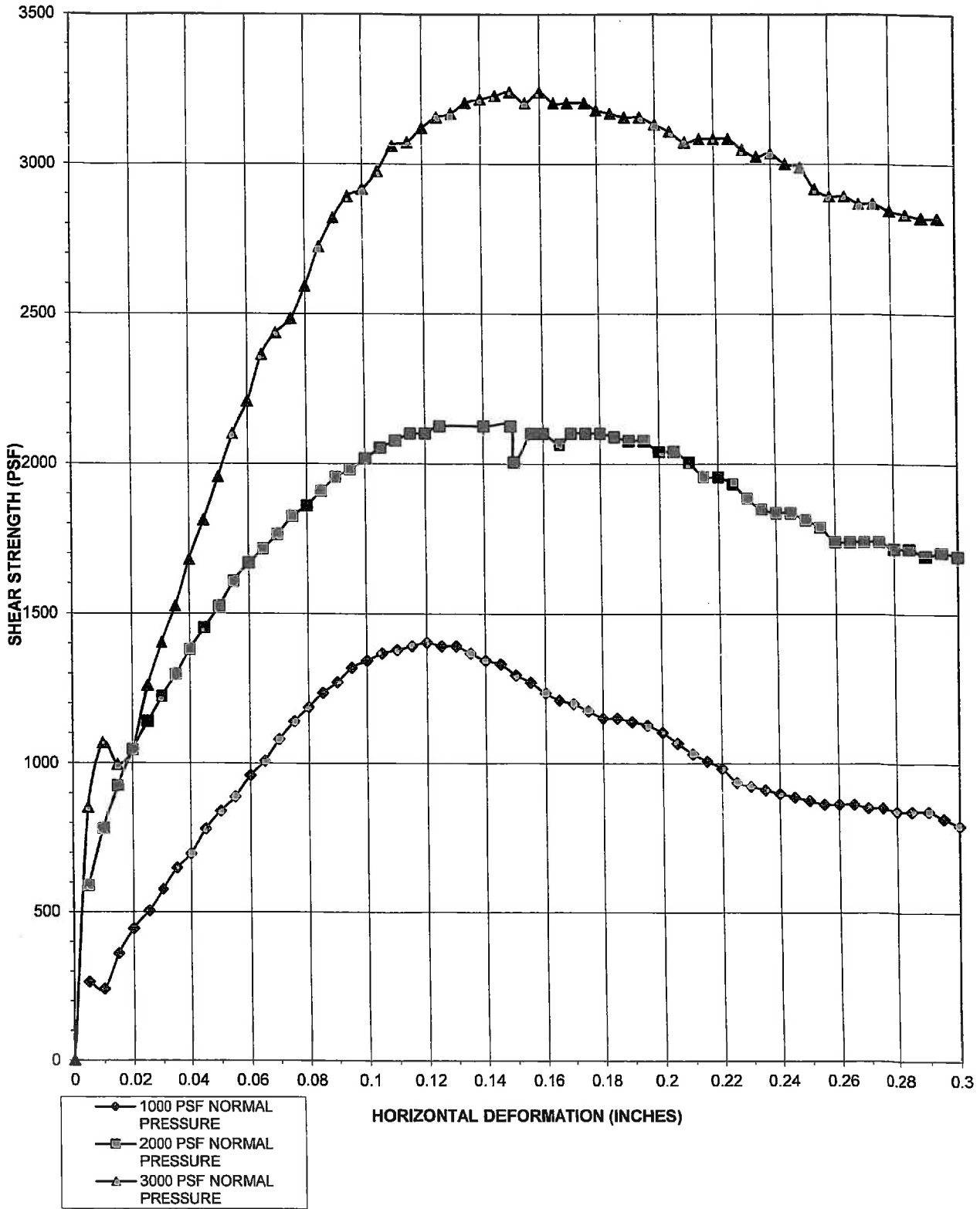

GH: 16870-G
CLIENT: Harvard-Westlake
DATE: 12/2014
SAMPLE ID: GHB-4 @54ft

DIRECT SHEAR TEST

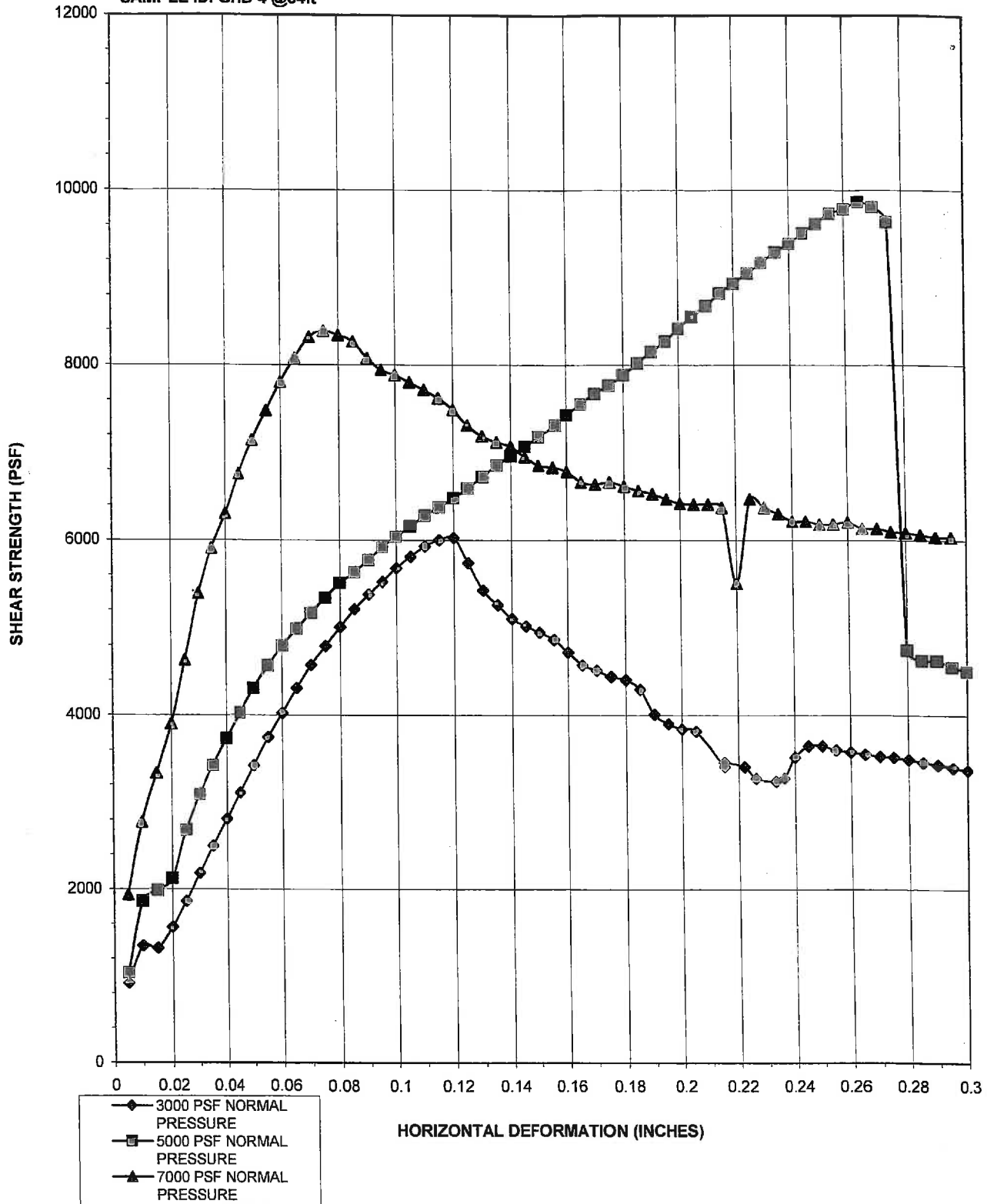

GH: 16870-G
CLIENT: Harvard-Westlake
DATE: 11/2014
SAMPLE ID: GHB-4 @62-72'

DIRECT SHEAR TEST

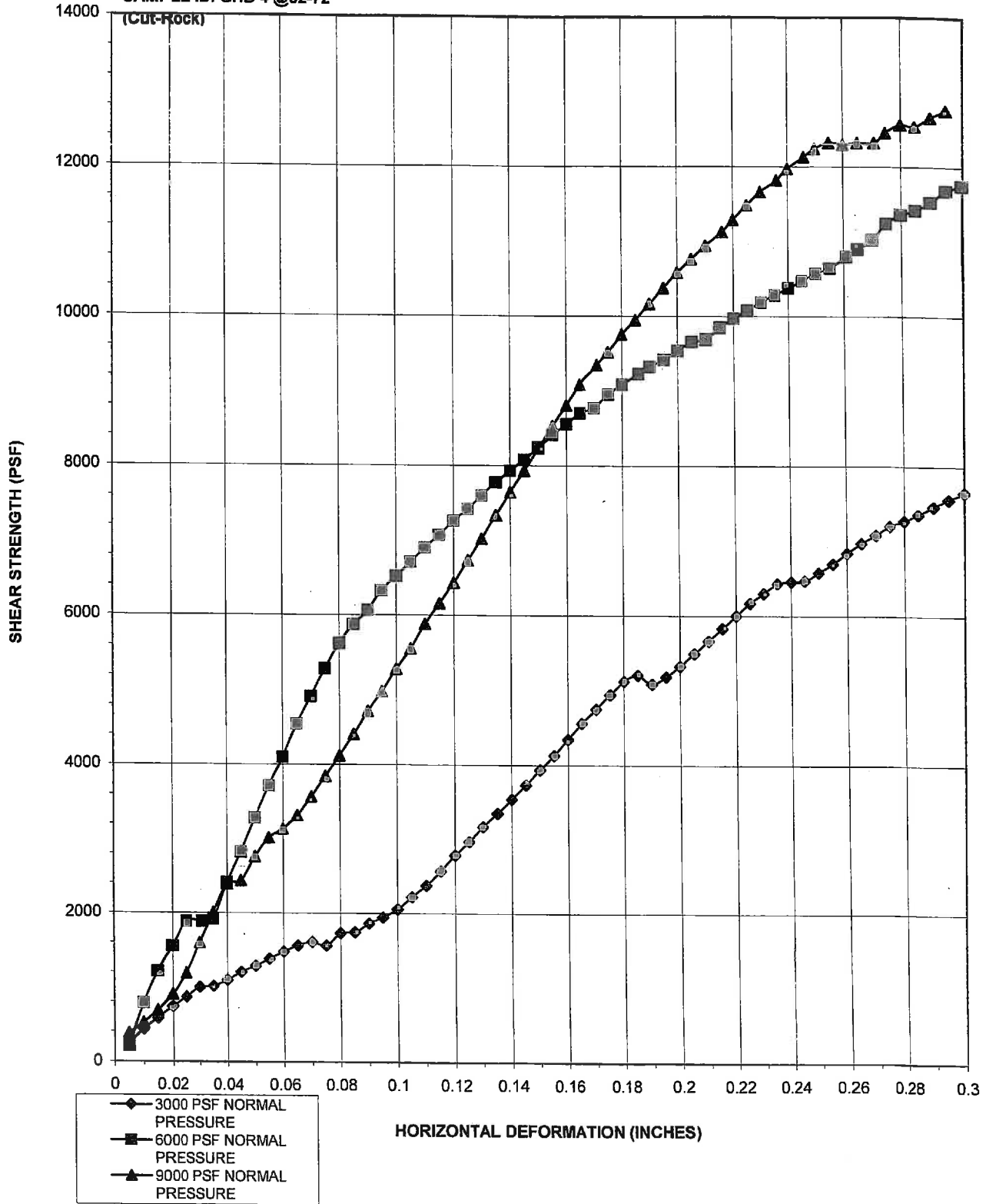

GH: 16870-G
CLIENT: Harvard-Westlake
DATE: 11/2014
SAMPLE ID: GHB-7 @5'

DIRECT SHEAR TEST

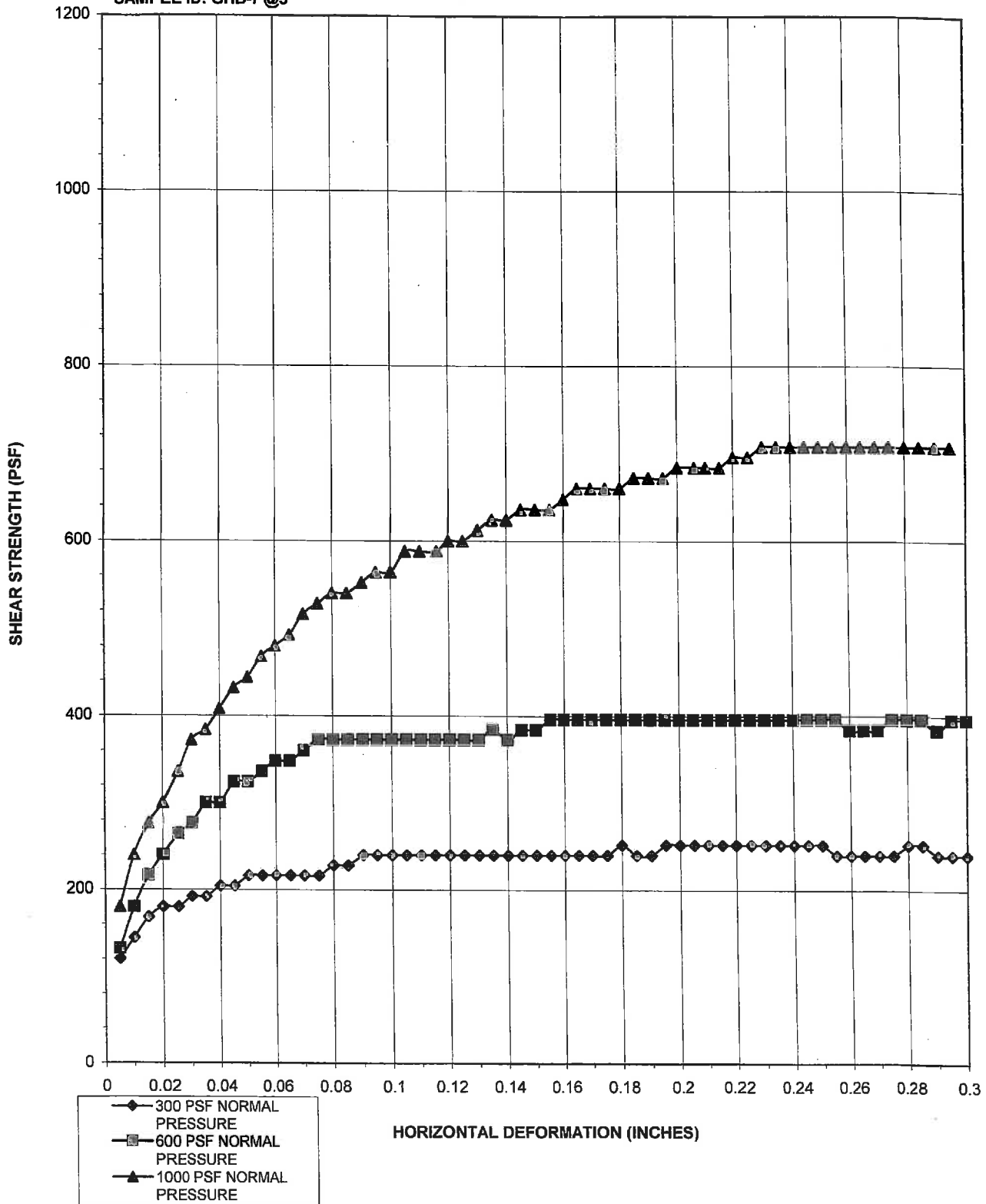

GH: 16870-G
CLIENT: Harvard-Westlake
DATE: 11/2014
SAMPLE ID: GHB-5 @10'
(Reshear Test 1)

DIRECT SHEAR TEST

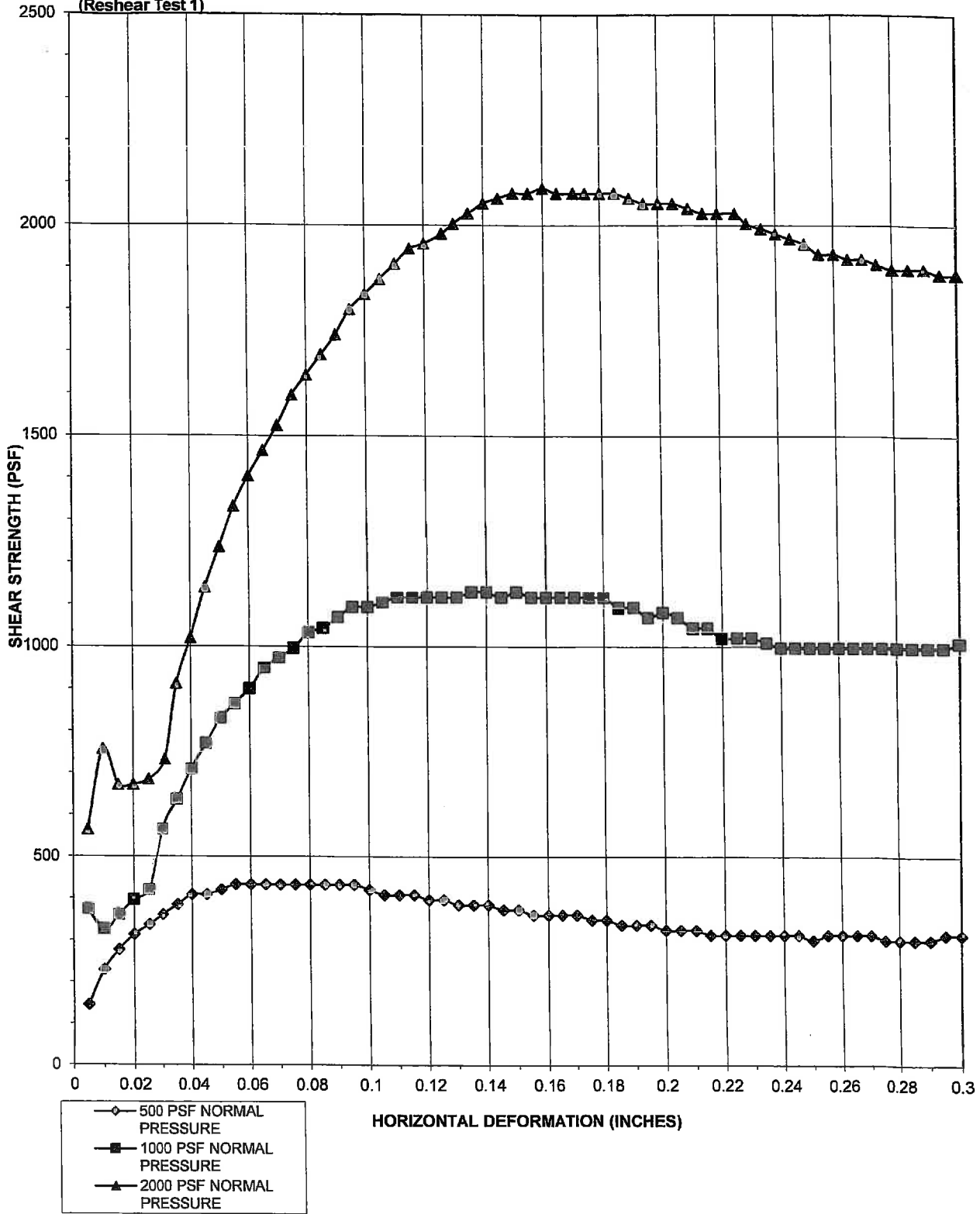

GH: 16870-G
CLIENT: Harvard-Westlake
DATE: 11/2014
SAMPLE ID: GHB-5 @10'
(Reshear Test 2)

DIRECT SHEAR TEST

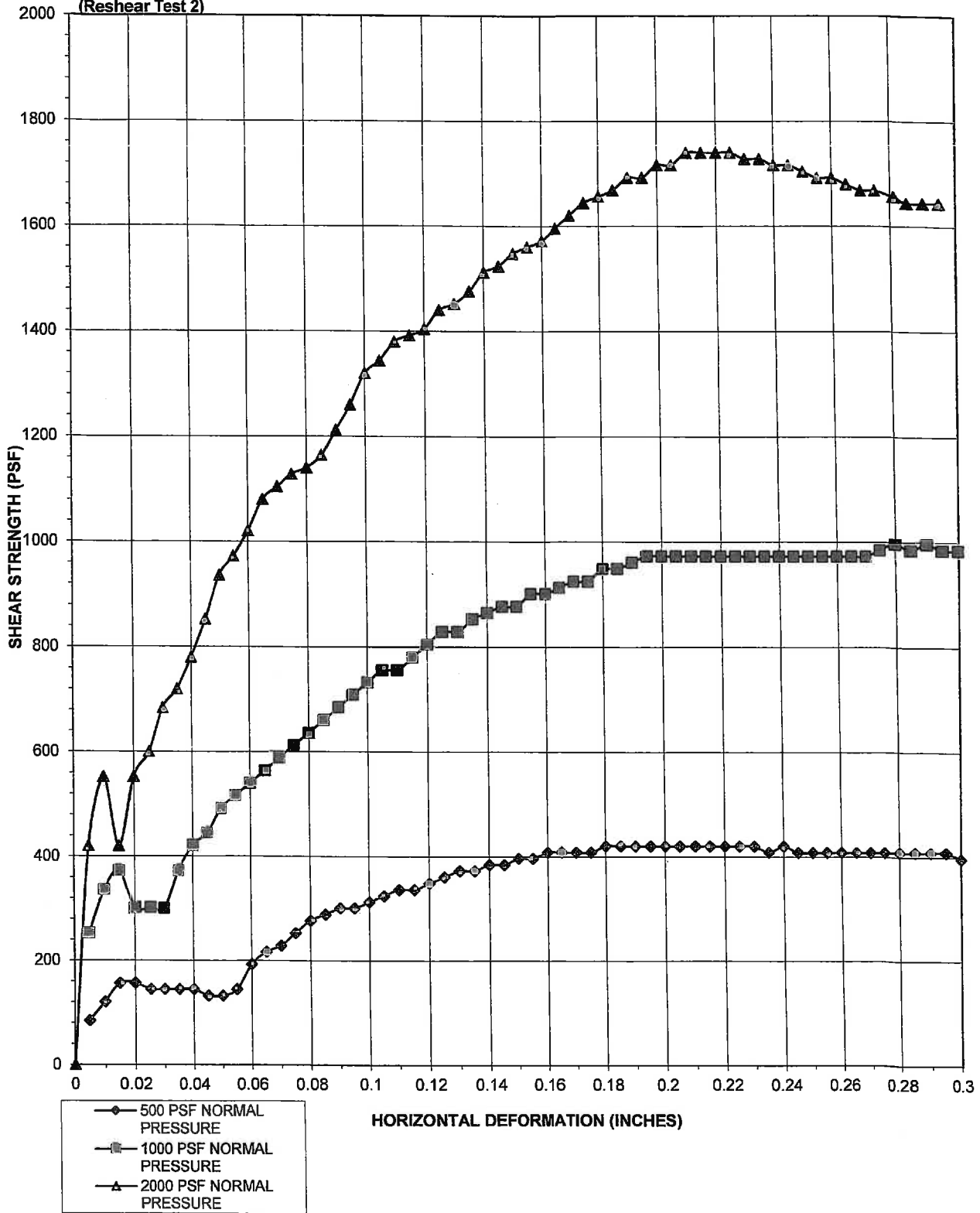

GH: 16870-G
CLIENT: Harvard-Westlake
DATE: 12/2014
SAMPLE ID: GHB-5 @50ft

DIRECT SHEAR TEST

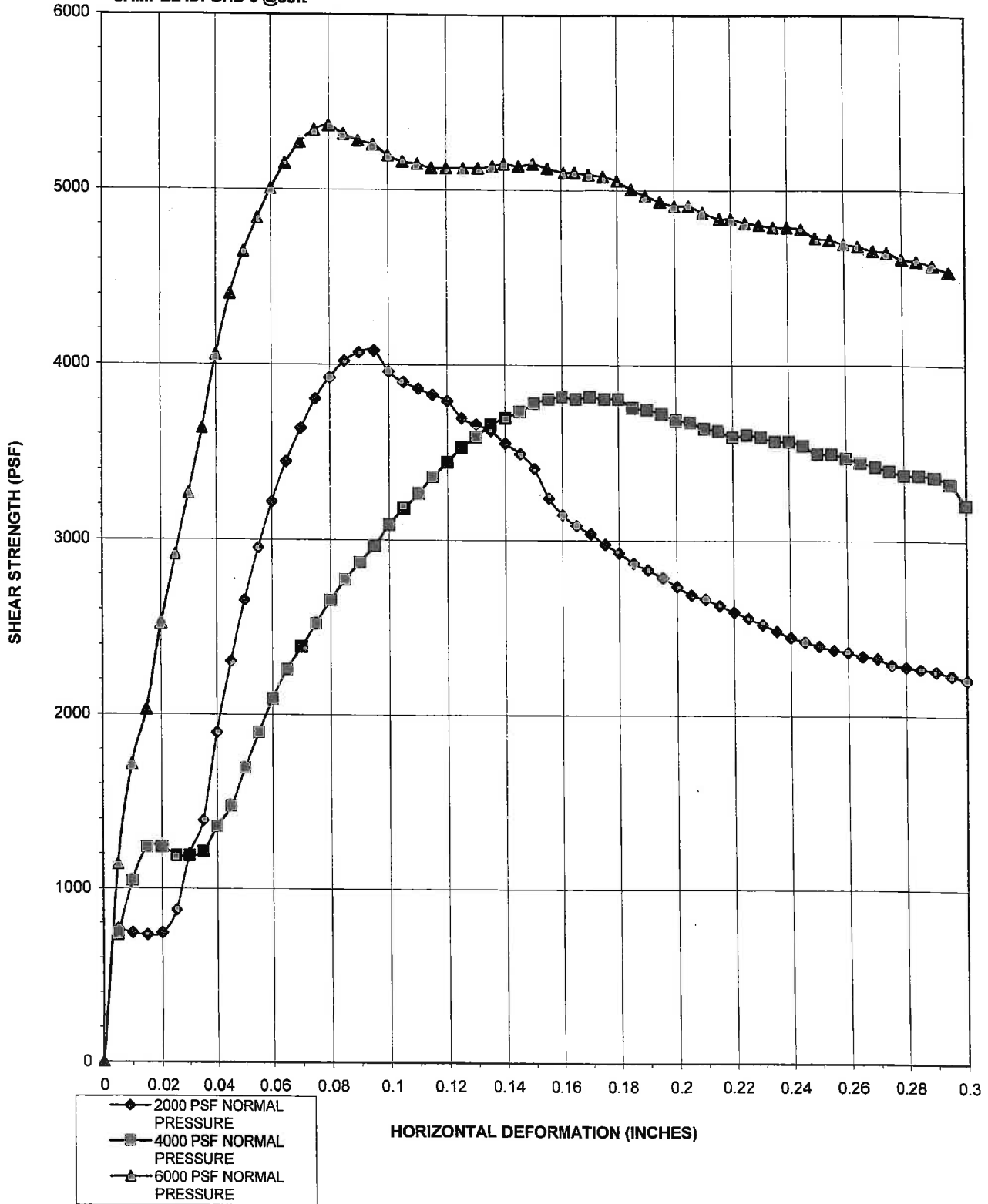

GH: 16870-G
CLIENT: Harvard-Westlake
DATE: 12/2014
SAMPLE ID: GHB-5 @60ft

DIRECT SHEAR TEST

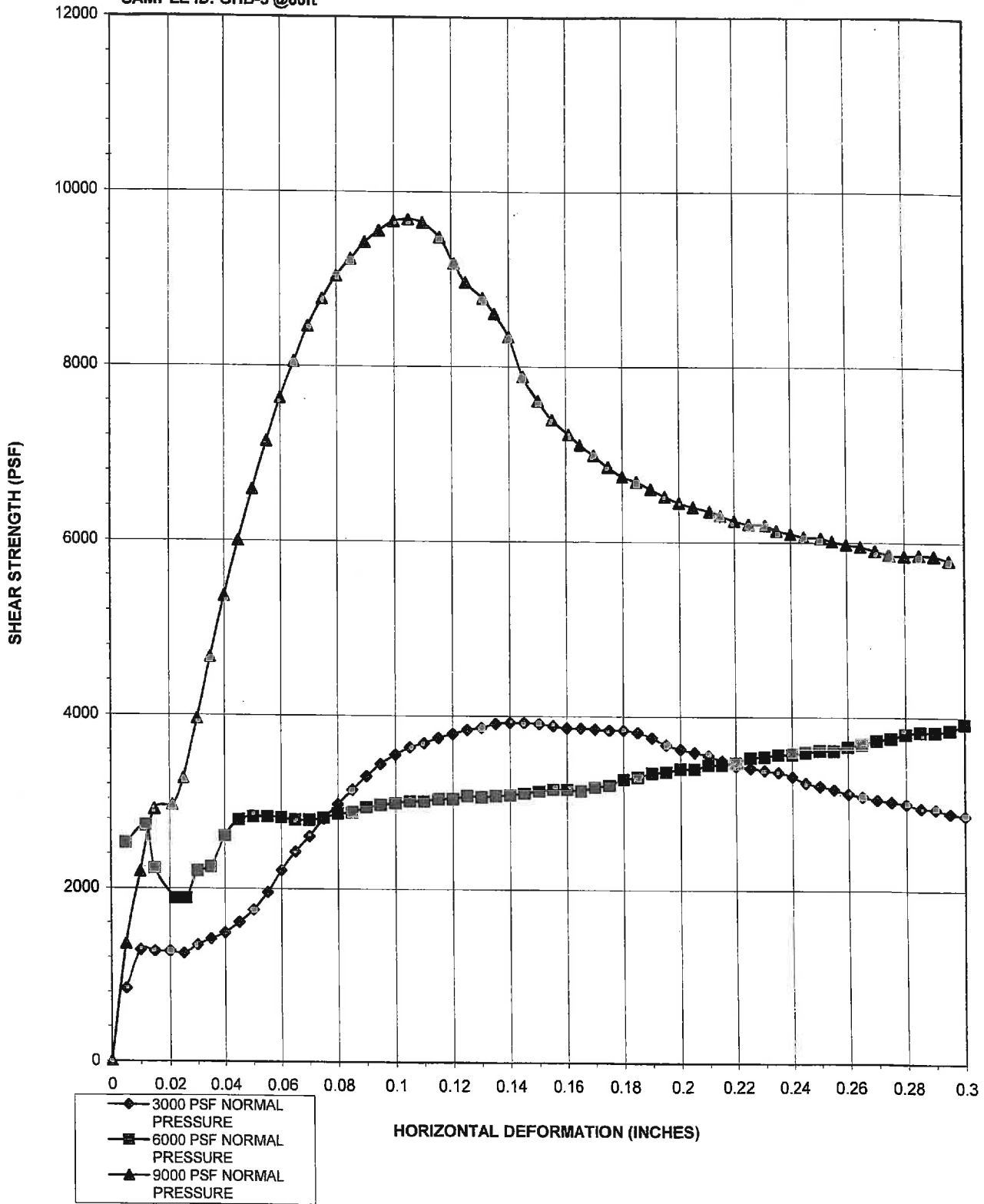

GH: 16870-G
CLIENT: Harvard-Westlake
DATE: 11/2014
SAMPLE ID: GHB-6 @5'

DIRECT SHEAR TEST

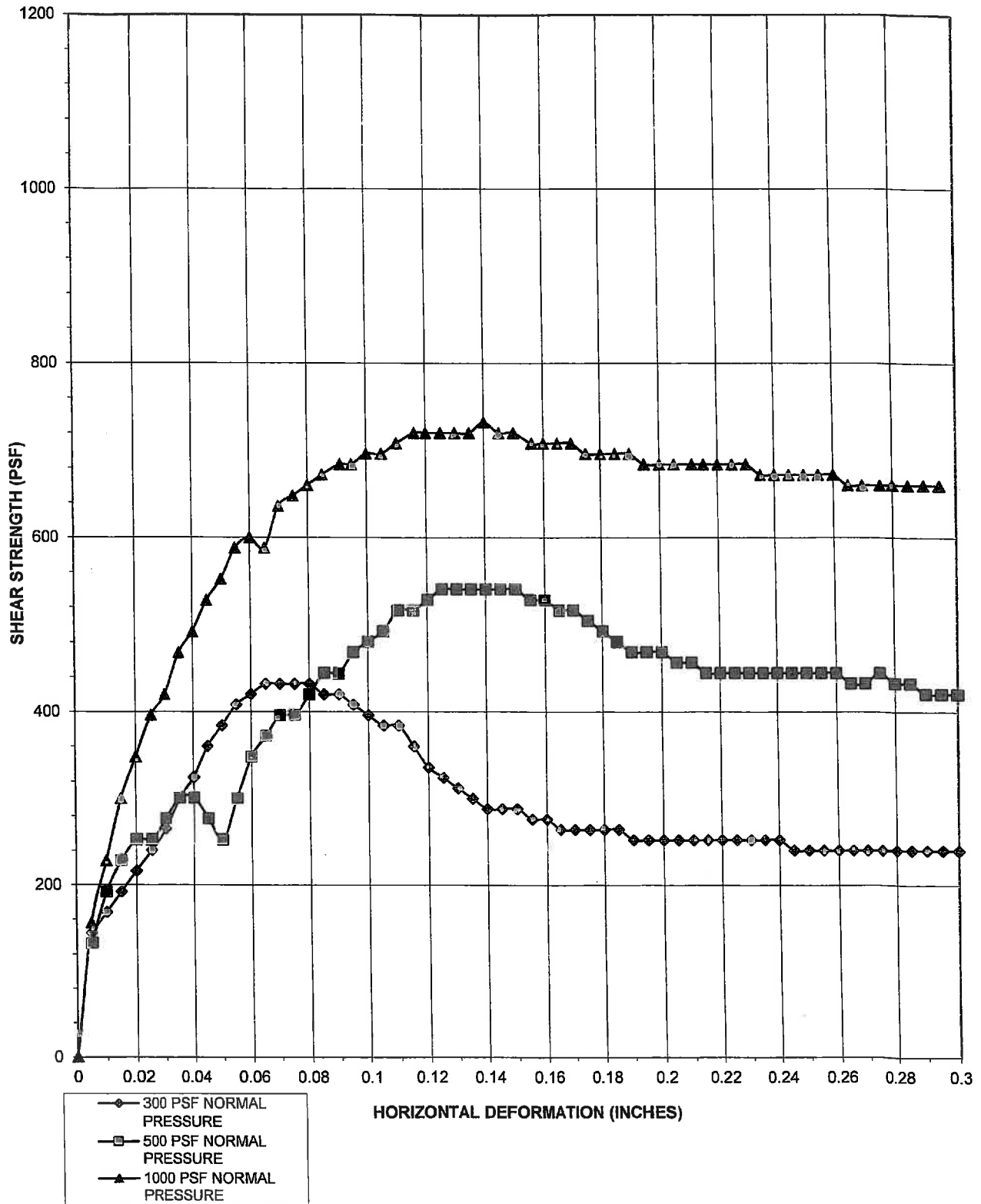

GH: 16870-G
CLIENT: Harvard-Westlake
DATE: 11/2014
SAMPLE ID: GHB-6 @15'

DIRECT SHEAR TEST

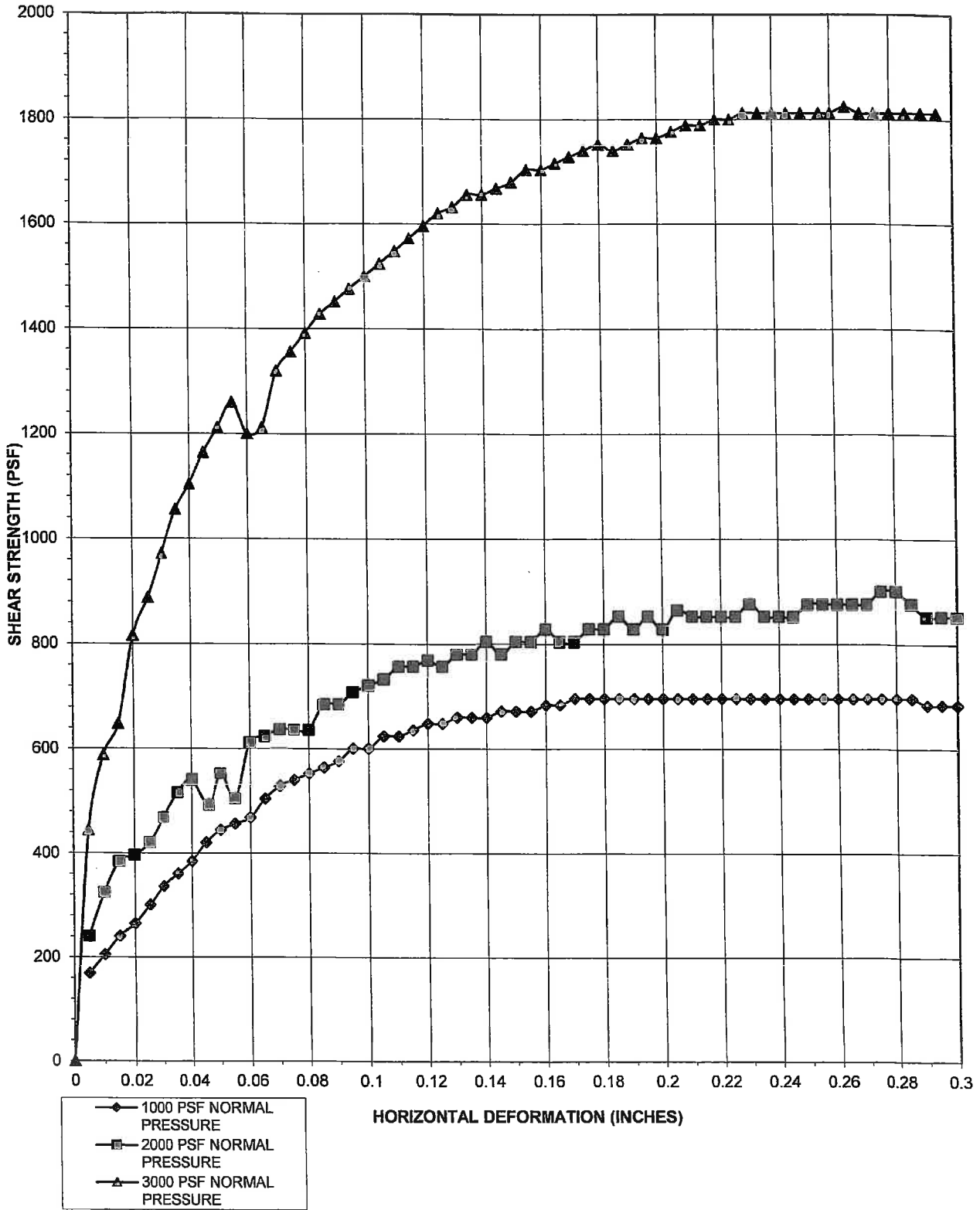

GH: 16870-G
CLIENT: Harvard-Westlake
DATE: 11/2014
SAMPLE ID: GHB-6 @25'

DIRECT SHEAR TEST

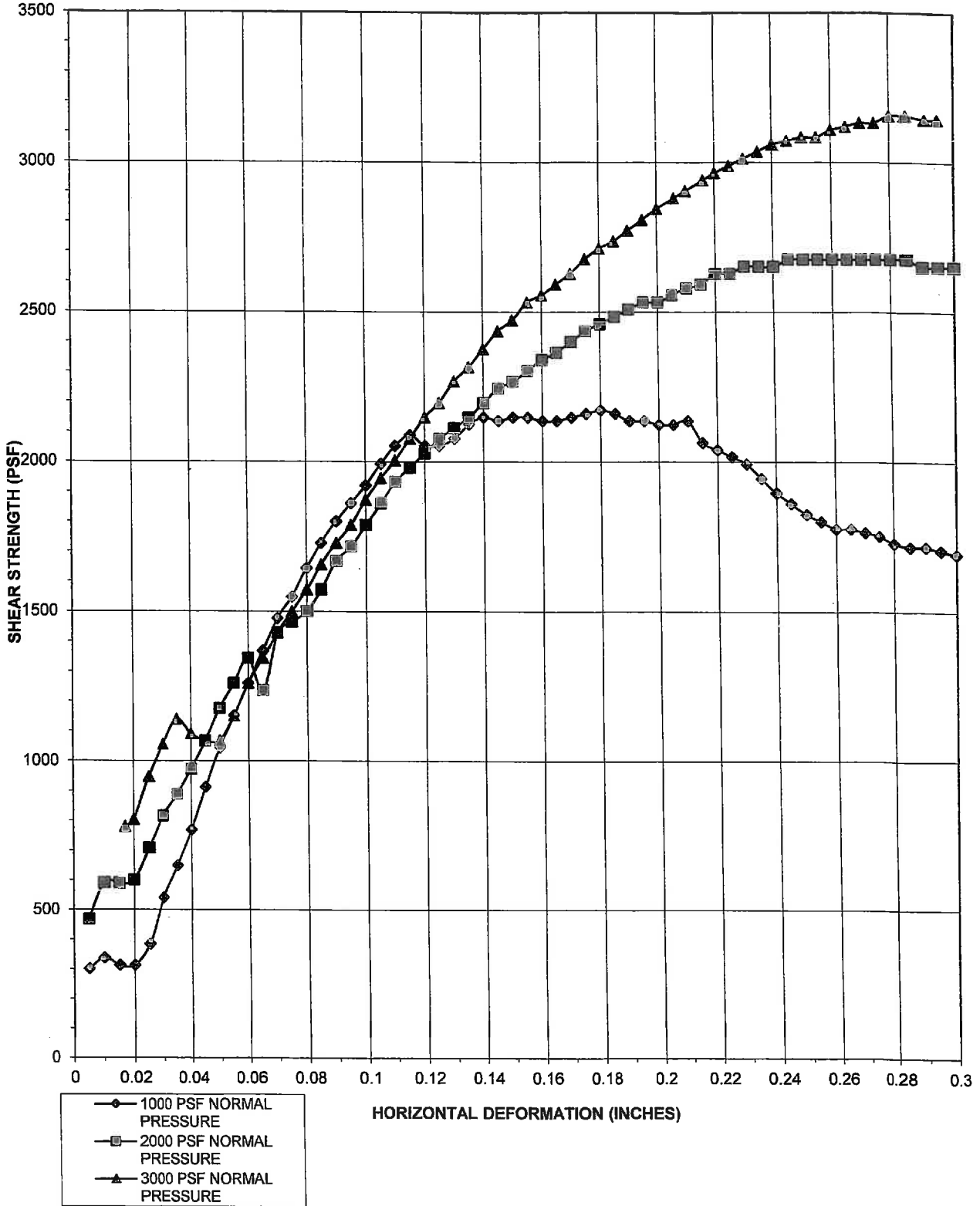

GH: 16870-G
CLIENT: Harvard-Westlake
DATE: 11/2014
SAMPLE ID: GHB-6 @35'

DIRECT SHEAR TEST

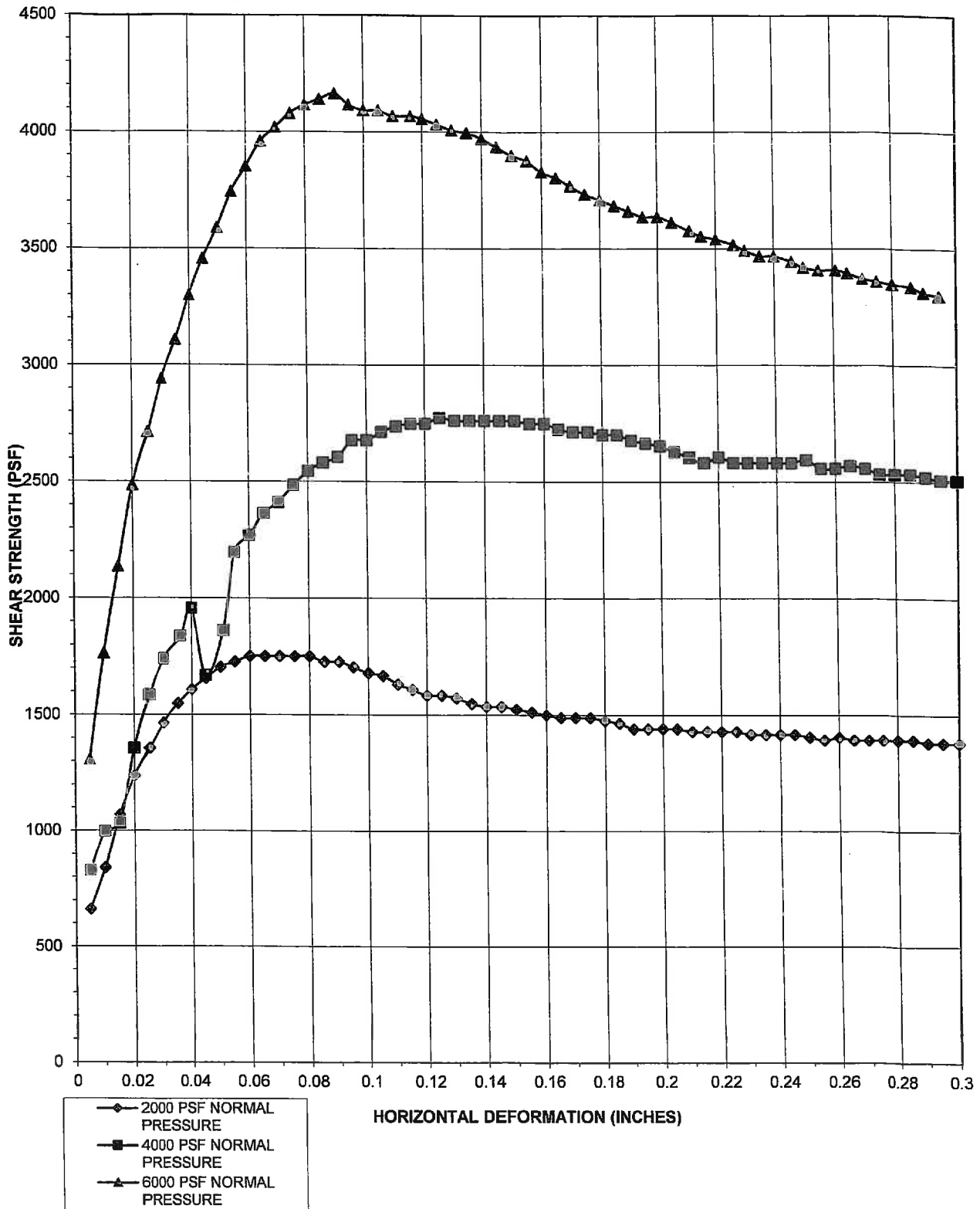

GH: 16870-G
CLIENT: Harvard-Westlake
DATE: 11/2014
SAMPLE ID: GHB-7 @15'

DIRECT SHEAR TEST

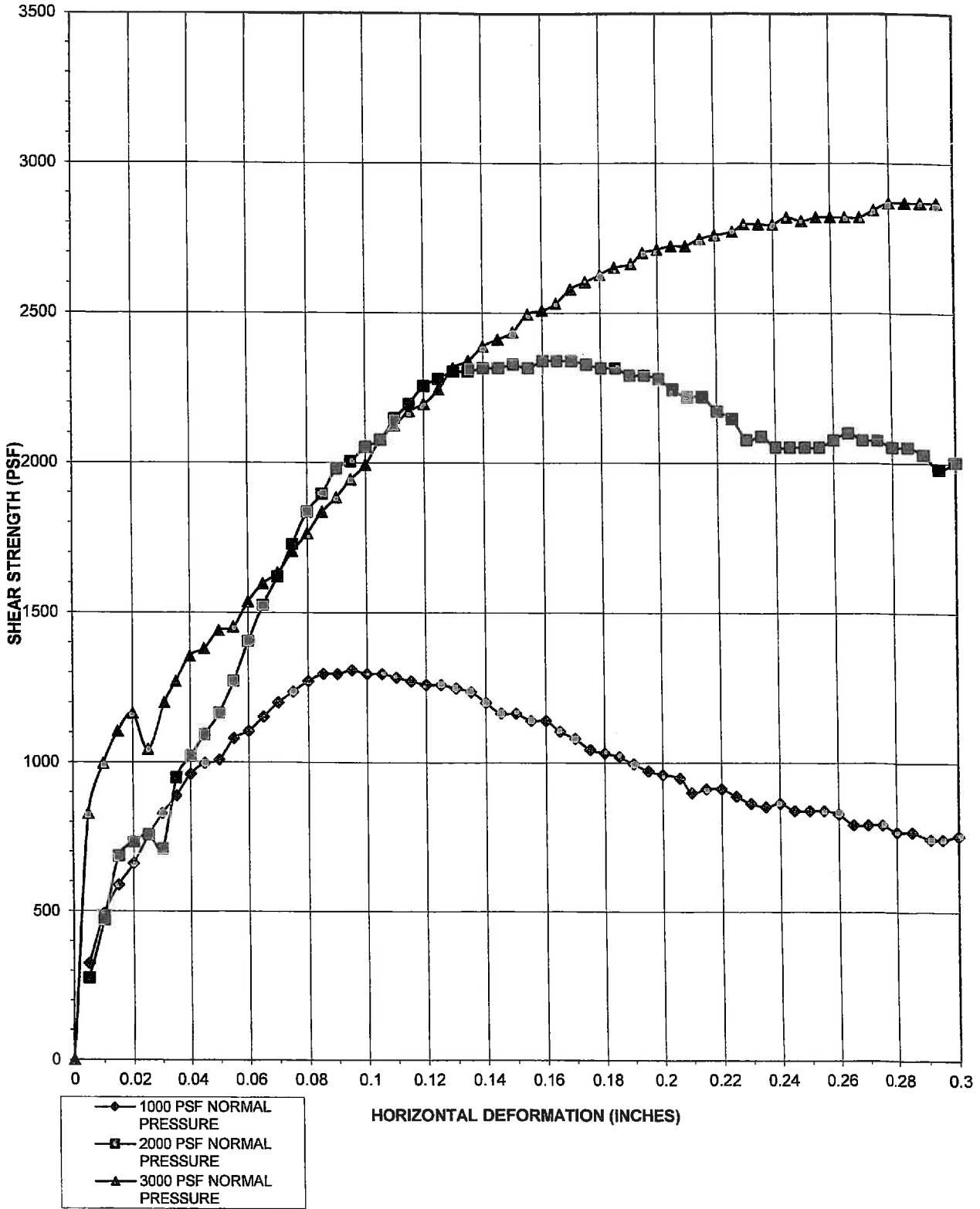

GH: 16870-G
CLIENT: Harvard-Westlake
DATE: 11/2014
SAMPLE ID: GHB-7 @25'

DIRECT SHEAR TEST

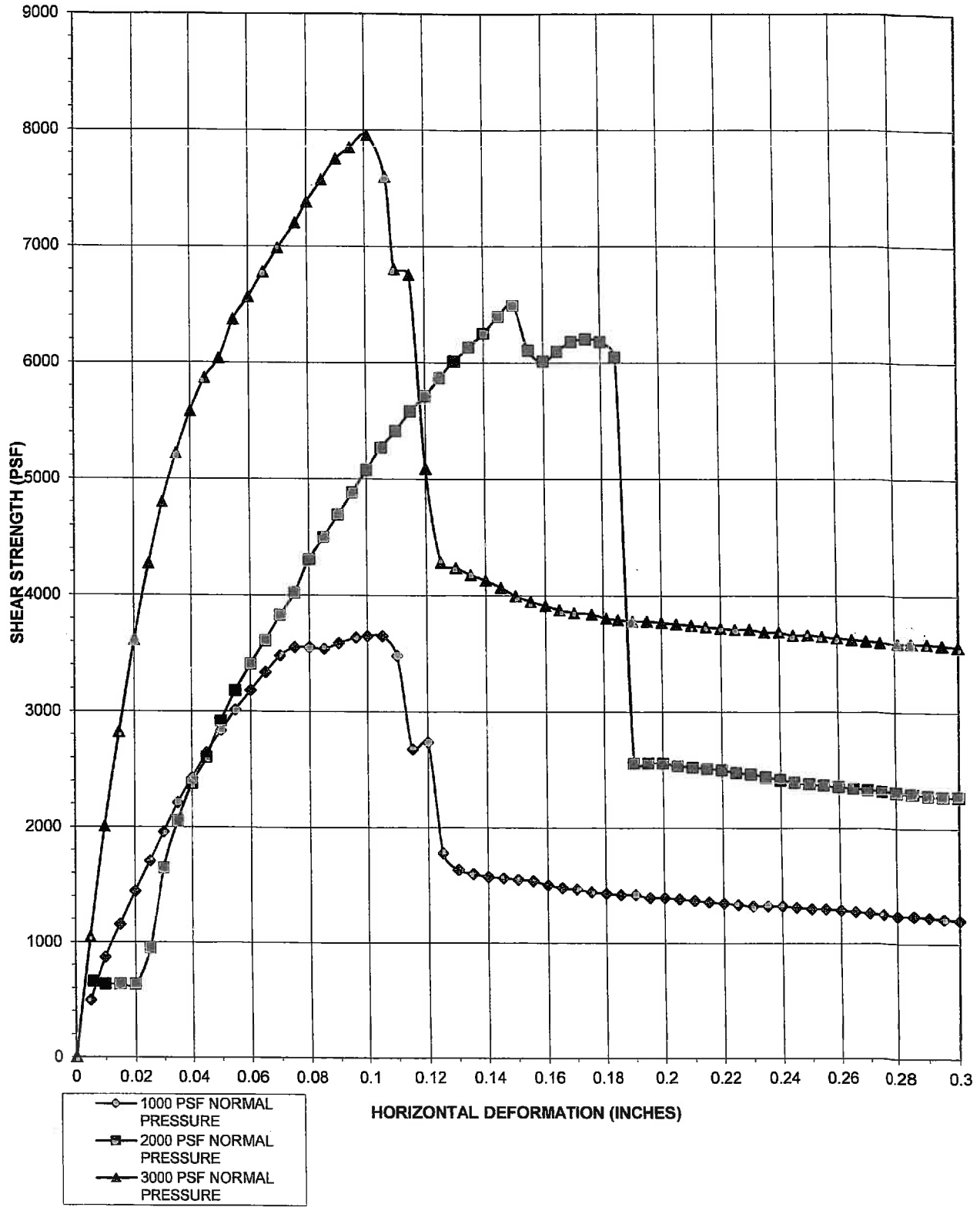

GH: 16870-G
CLIENT: Harvard-Westlake
DATE: 11/2014
SAMPLE ID: GHB-8 @10'

DIRECT SHEAR TEST

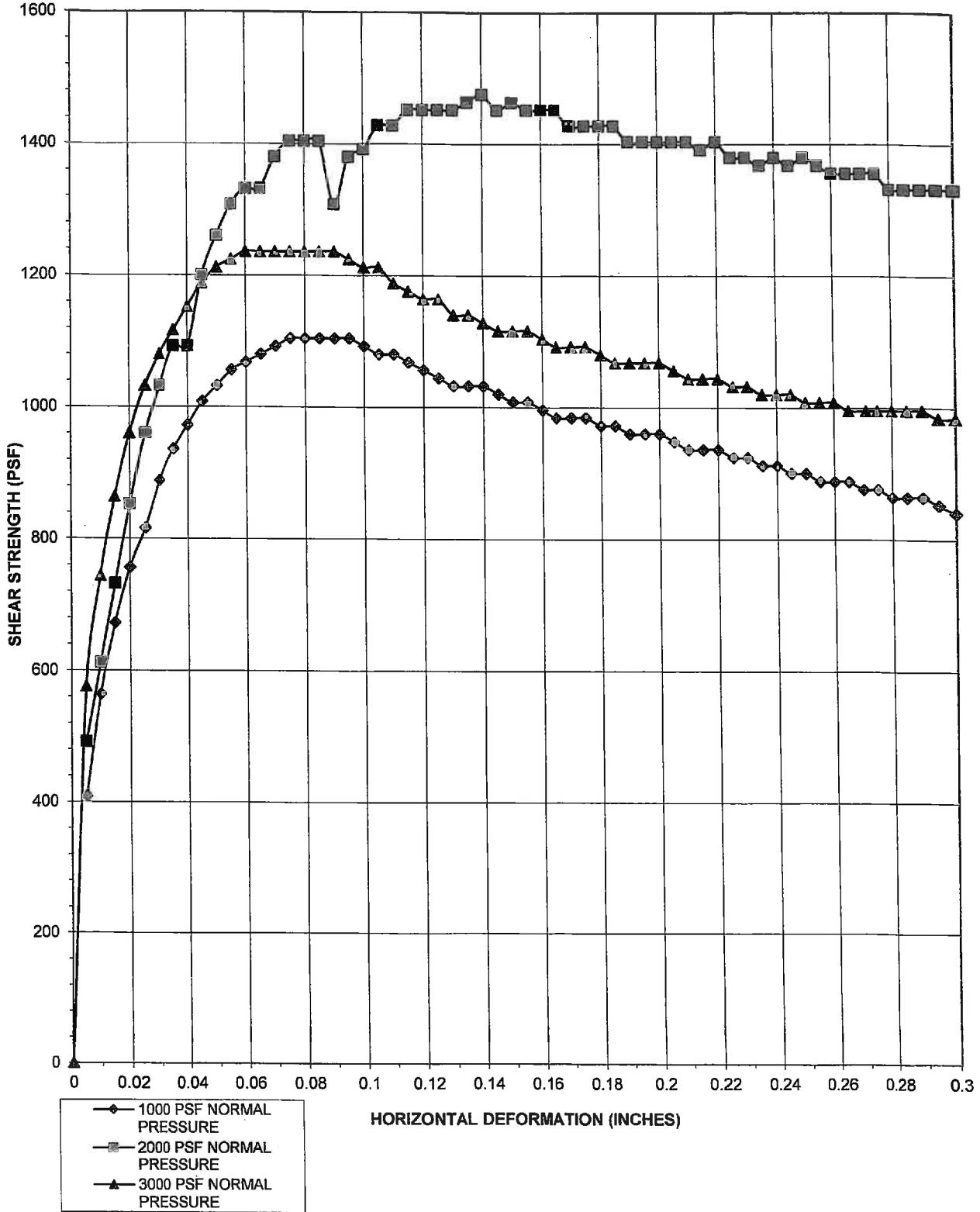

GH: 16870-G
CLIENT: Harvard-Westlake
DATE: 11/2014
SAMPLE ID: GHB-8 @15'

DIRECT SHEAR TEST

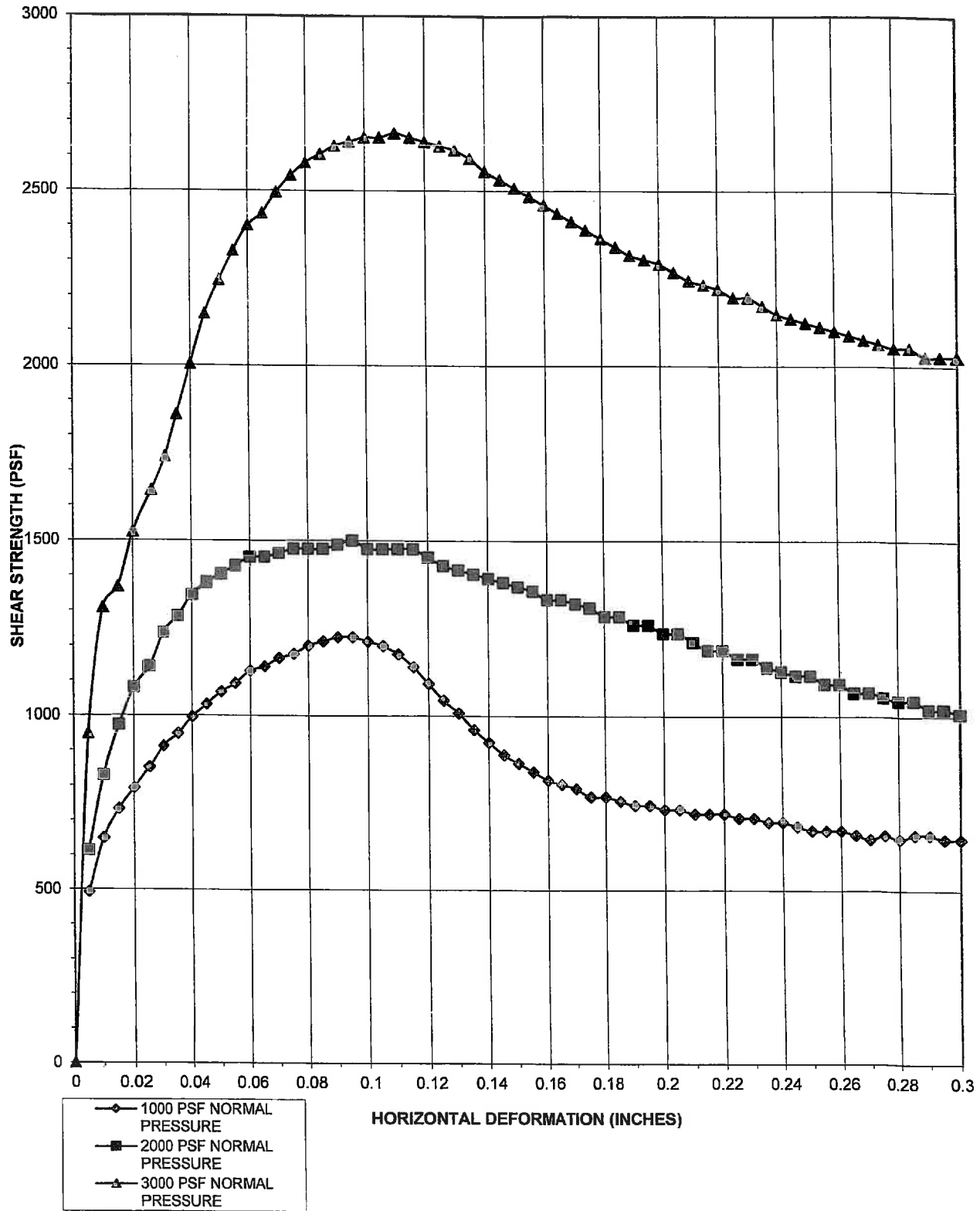

GH: 16870-G
CLIENT: Harvard-Westlake
DATE: 11/2014
SAMPLE ID: GHB-8 @17.5'

DIRECT SHEAR TEST

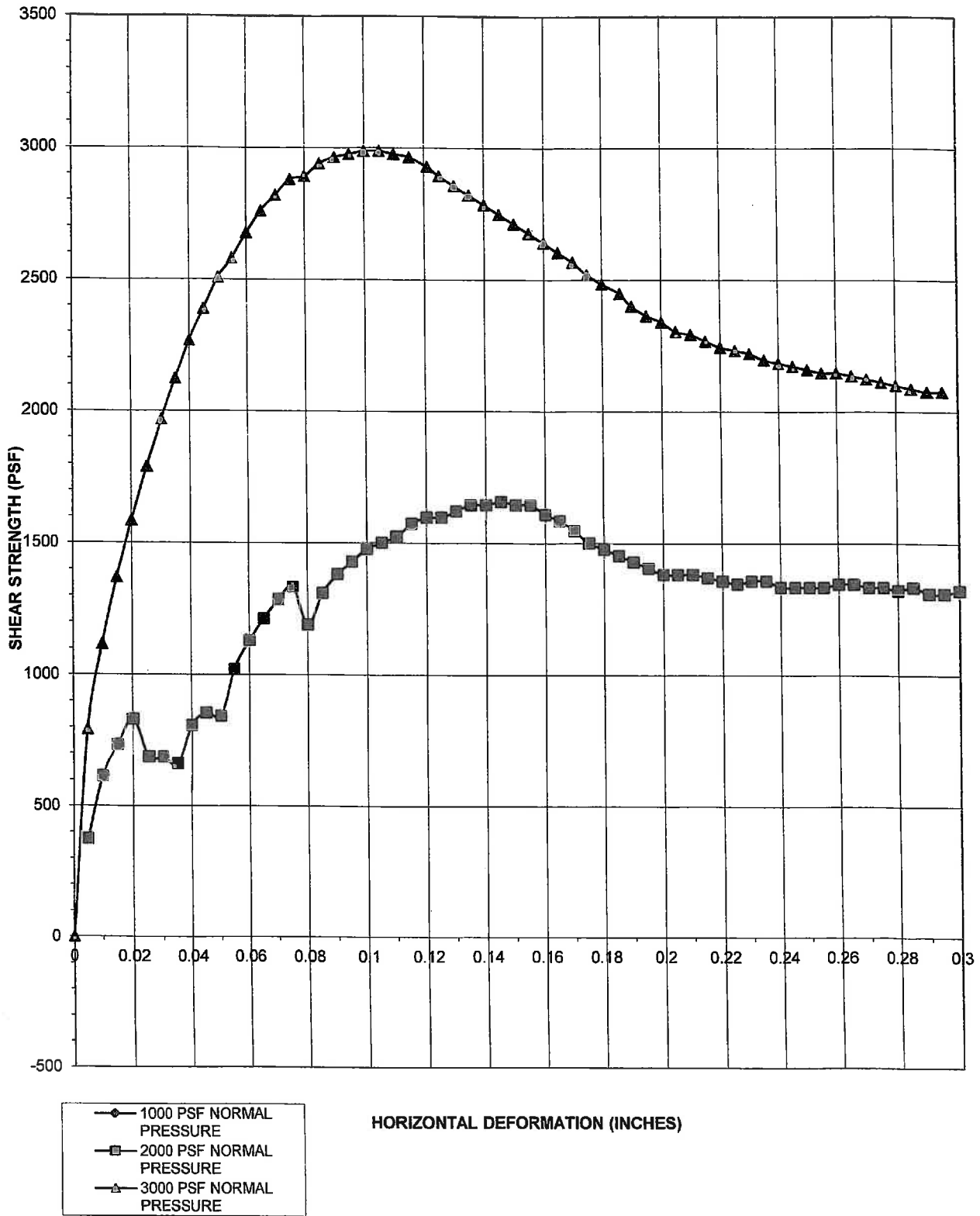

GH: 16870-G
CLIENT: Harvard-Westlake
DATE: 11/2014
SAMPLE ID: GHB-8 @22.5'

DIRECT SHEAR TEST

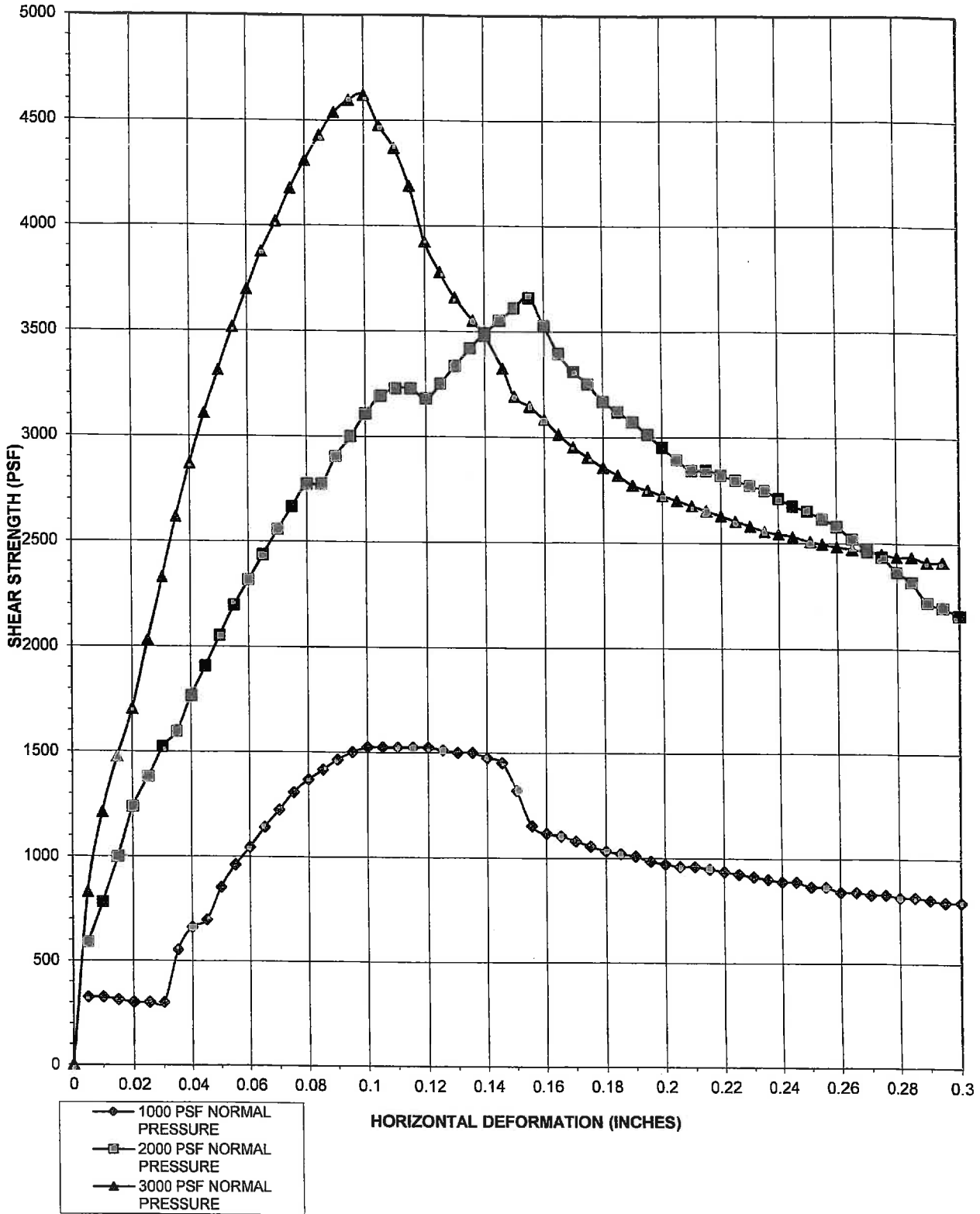

GH: 16870-G
CLIENT: Harvard-Westlake
DATE: 11/2014
SAMPLE ID: GHB-8 @35'

DIRECT SHEAR TEST

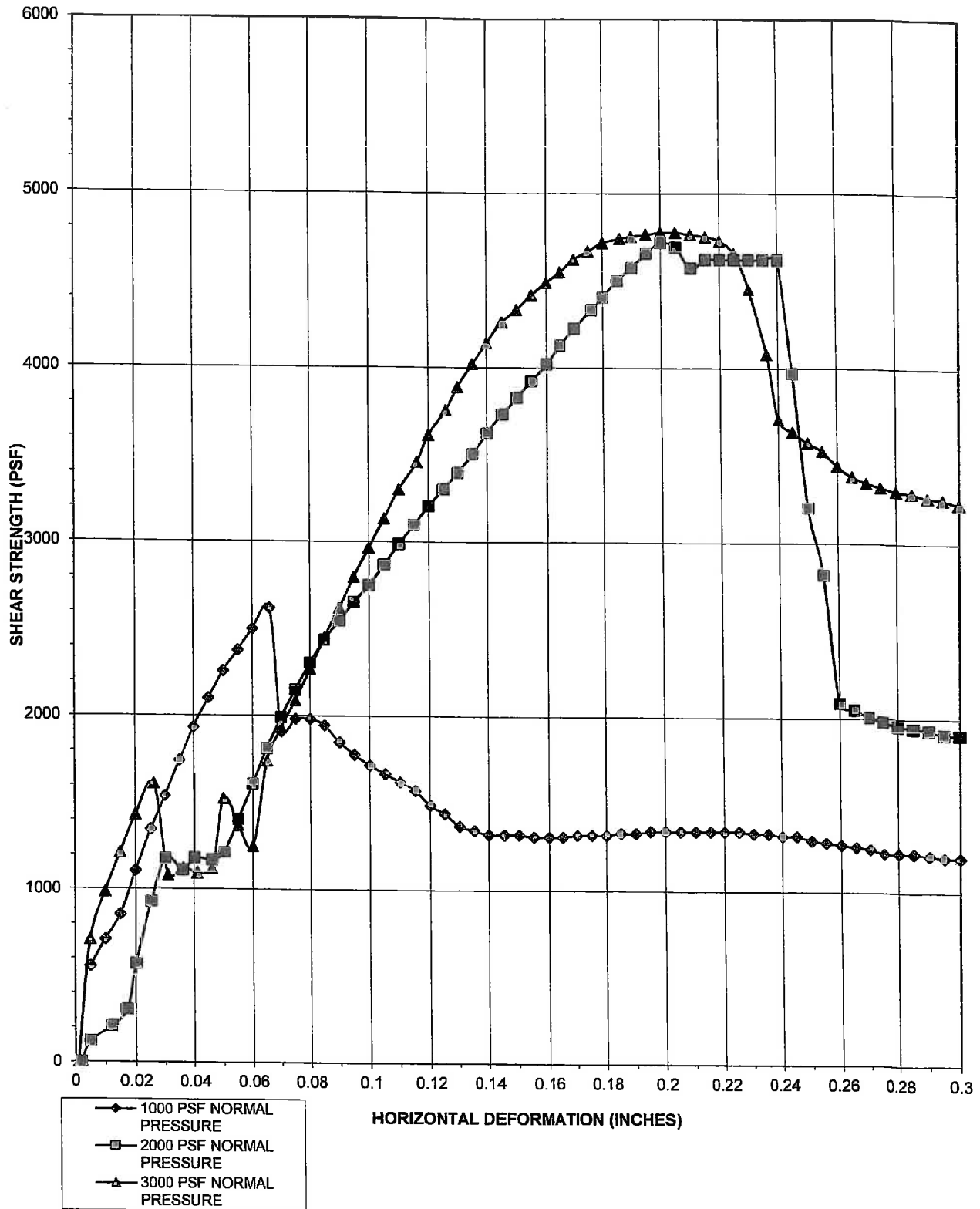



TRANSMITTAL LETTER

DATE: November 3, 2014

ATTENTION: Martin

TO: Grover-Hollingsworth
31129 Via Colinas
Westlake Village, CA 91362

SUBJECT: Laboratory Test Data
Harvard Westlake School
Your #16870-G, HDR Lab #14-0822LAB

COMMENTS: Enclosed are the results for the subject project.

A handwritten signature in black ink, appearing to read 'Julie L.S. Bell'. The signature is written in a cursive style with a horizontal line underneath it.

Julie L.S. Bell
Laboratory Supervisor



Table 1 - Laboratory Tests on Soil Samples

*Grover-Hollingsworth
Harvard Westlake School
Your #16870-G, HDR Lab #14-0822LAB
20-Oct-14*

Sample ID			GHB-4	GHB-5
			@ 70'	@ 47'
			Unoxidized Bedrock	Oxidized Bedrock
Resistivity		Units		
as-received		ohm-cm	60,000	32,000
saturated		ohm-cm	840	480
pH			7.1	4.6
Electrical				
Conductivity		mS/cm	1.59	2.67
Chemical Analyses				
Cations				
calcium	Ca ²⁺	mg/kg	1,666	2,162
magnesium	Mg ²⁺	mg/kg	163	472
sodium	Na ¹⁺	mg/kg	112	462
potassium	K ¹⁺	mg/kg	143	77
Anions				
carbonate	CO ₃ ²⁻	mg/kg	ND	ND
bicarbonate	HCO ₃ ¹⁻	mg/kg	332	ND
fluoride	F ¹⁻	mg/kg	3.6	40
chloride	Cl ¹⁻	mg/kg	38	643
sulfate	SO ₄ ²⁻	mg/kg	4,335	6,755
phosphate	PO ₄ ³⁻	mg/kg	ND	ND
Other Tests				
ammonium	NH ₄ ¹⁺	mg/kg	10	2.9
nitrate	NO ₃ ¹⁻	mg/kg	2.7	706
sulfide	S ²⁻	qual	NA	NA
Redox		mV	NA	NA

Electrical conductivity in millisiemens/cm and chemical analysis were made on a 1:5 soil-to-water extract.

mg/kg = milligrams per kilogram (parts per million) of dry soil.

Redox = oxidation-reduction potential in millivolts

ND = not detected

na = not analyzed

May 18, 2015
BG 21898

APPENDIX VI

Laboratory Testing, Calculations, and Figures (Current Study)

May 18, 2015
BG 21898

LABORATORY TESTING

Undisturbed and bulk samples of the alluvium and bedrock were obtained from the test pits site and transported to the laboratory for testing and analysis.

Corrosion

The samples of alluvium and bedrock were transported to Environmental Geotechnology Laboratory for chemical testing. The testing was performed in accordance with Caltrans Standards 643 (pH), 422 (Chloride Content), 417 (Sulfate Content), and 532 (Resistivity). The results of the testing are reported in the enclosed Summary of Corrosion Test Results.

The pH is near neutral and not a factor. The resistivity indicates that the bedrock is severely corrosive and the alluvium is corrosive to ferrous metals. The chloride and sulfate contents are negligible and not a factor in corrosion.

TABLE I - MOISTURE/DENSITY

Boring	Depth (ft)	Dry Density (pcf)	Moisture Content %	Soil Type
GH-B1	10	54.9	53.6	Bedrock
	20	75.9	38.7	Bedrock
	30	74.7	41.3	Bedrock
	40	69.6	49.7	Bedrock
	50	67.2	52.2	Bedrock
GH-B2	5	76.0	14.4	Alluvium
	15	81.8	17.6	Alluvium
	25	62.7	50.6	Bedrock
	40	74.0	45.1	Bedrock
	45	65.5	56.1	Bedrock
	55	50.3	85.9	Bedrock
GH-B3	65	40.7	96.5	Bedrock
	15	59.3	57.1	Bedrock
	25	56.2	62.3	Bedrock
	35	39.3	116.2	Bedrock
	45	40.5	109.4	Bedrock
GH-B4	10	87.1	25.7	Bedrock
	20	46.0	83.7	Bedrock
	30	55.9	68.7	Bedrock
	40	52.9	78.9	Bedrock
	60	70.2	46.6	Bedrock
	70	64.1	39.0	Bedrock

TABLE I - MOISTURE/DENSITY (Continued)

Boring	Depth (ft)	Dry Density (pcf)	Moisture Content %	Soil Type
GH-B5	5	49.6	68.8	Fill
	15	69.4	29.2	Alluvium
	25	78.1	21.3	Alluvium
	35	38.6	202.5	Bedrock
	45	93.4	15.9	Bedrock
	55	82.4	30.7	Bedrock
GH-B6	10	63.7	20.3	Alluvium
	20	88.7	21.8	Alluvium
	30	71.6	40.1	Bedrock
	40	70.4	49.2	Bedrock
	50	72.7	41.8	Bedrock
GH-B7	10	79.3	21.9	Alluvium
	20	38.7	106.7	Bedrock
	30	51.0	86.3	Bedrock



**BYER
GEOTECHNICAL
INC.**

1461 E. CHEVY CHASE DRIVE, SUITE 200 GLENDALE, CA 91206
(818) 549-9959 Tel (818) 543-3747 FAX

SHEAR DIAGRAM #1

BG: 21898 CONSULTANT: JWB
CLIENT: HARVARD-WESTLAKE

EARTH MATERIAL: BEDROCK - NORTHERN UNIT

Phi Angle = 38 degrees
Cohesion = 1196 psf

Average Moisture Content
Average Dry Density (pcf)
Average Percent Saturation #DIV/0!

DIRECT SHEAR TEST - ASTM D-3080 (PEAK VALUES)

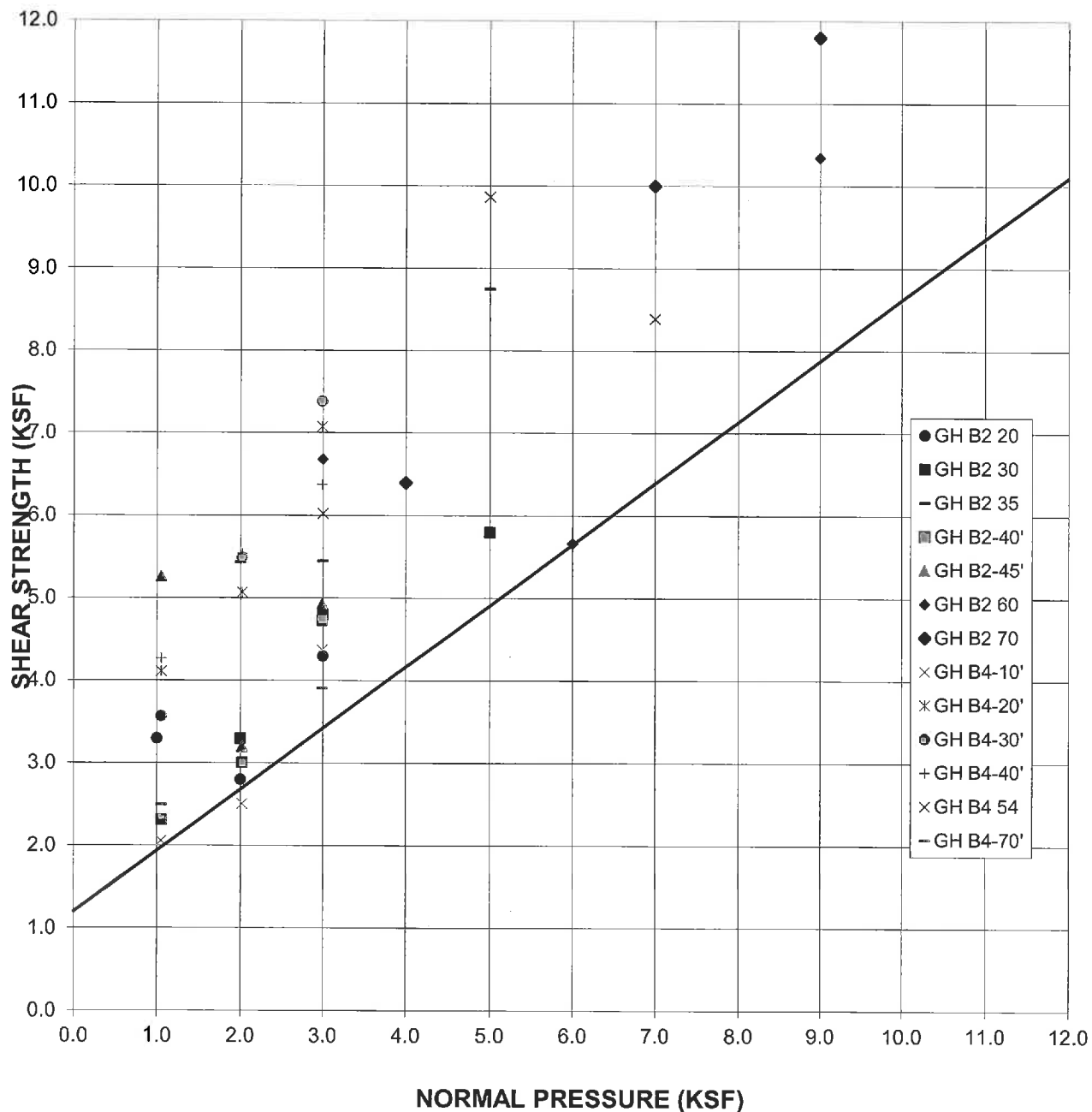



**BYER
GEOTECHNICAL
INC.**

1461 E. CHEVY CHASE DRIVE, SUITE 200 GLENDALE, CA 91206
(818) 549-9959 Tel (818) 543-3747 FAX

SHEAR DIAGRAM #2

BG: **21898** CONSULTANT: **JWB**
CLIENT: **HARVARD-WESTLAKE**

EARTH MATERIAL: **BEDROCK - NORTHERN UNIT**

Phi Angle = 36.5 degrees
Cohesion = 1044 psf

Average Moisture Content
Average Dry Density (pcf)
Average Percent Saturation

DIRECT SHEAR TEST - ASTM D-3080 (ULTIMATE VALUES)

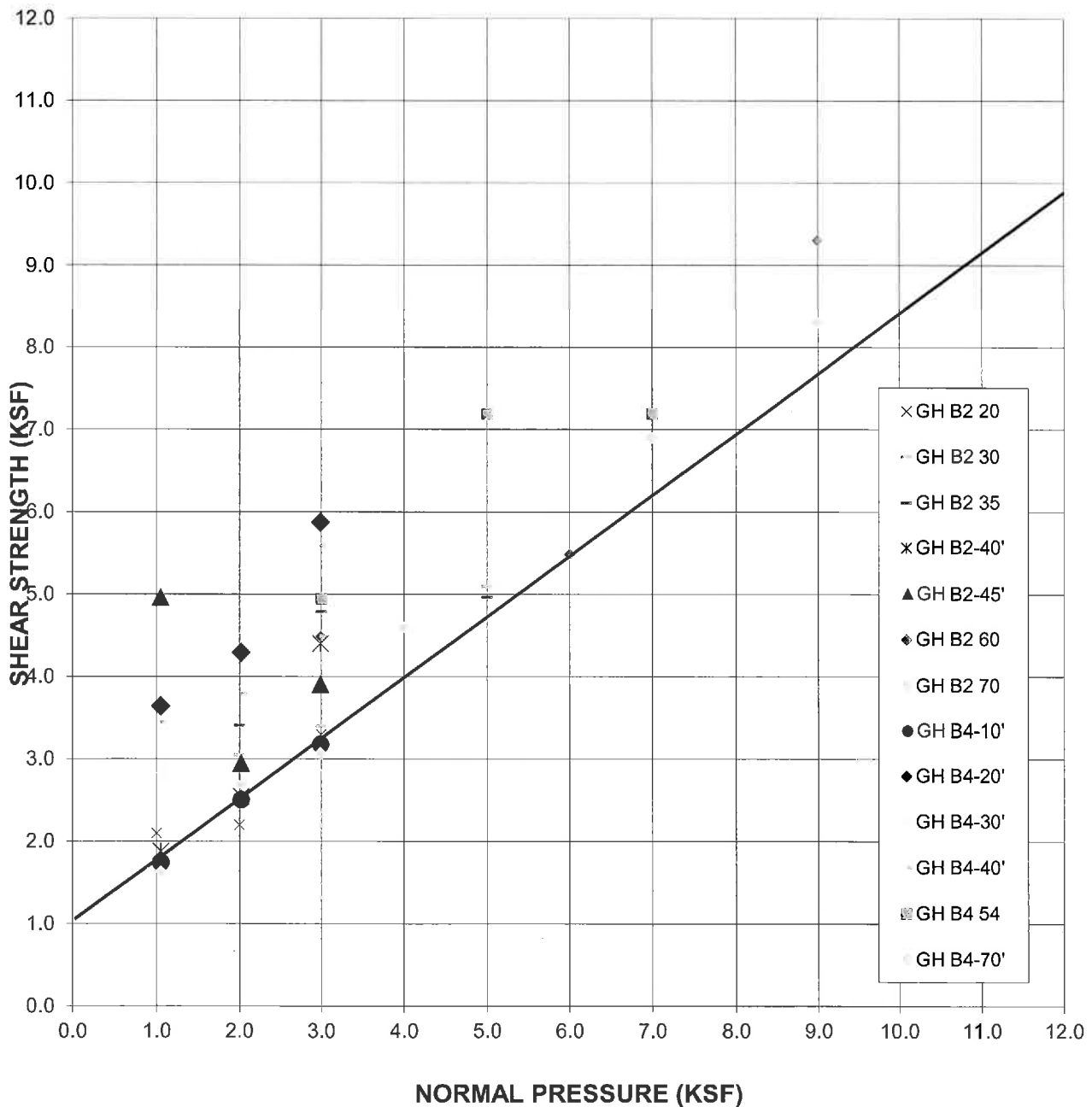



**BYER
GEOTECHNICAL
INC.**

1461 E. CHEVY CHASE DRIVE, SUITE 200 GLENDALE, CA 91206
(818) 549-9959 Tel (818) 543-3747 FAX

SHEAR DIAGRAM #3

BG: 21898 CONSULTANT: JWB
CLIENT: HARVARD-WESTLAKE

EARTH MATERIAL: BEDROCK - SOUTHERN UNIT

Phi Angle = 37 degrees
Cohesion = 825 psf

Average Moisture Content
Average Dry Density (pcf)
Average Percent Saturation #DIV/0!

DIRECT SHEAR TEST - ASTM D-3080 (PEAK VALUES)

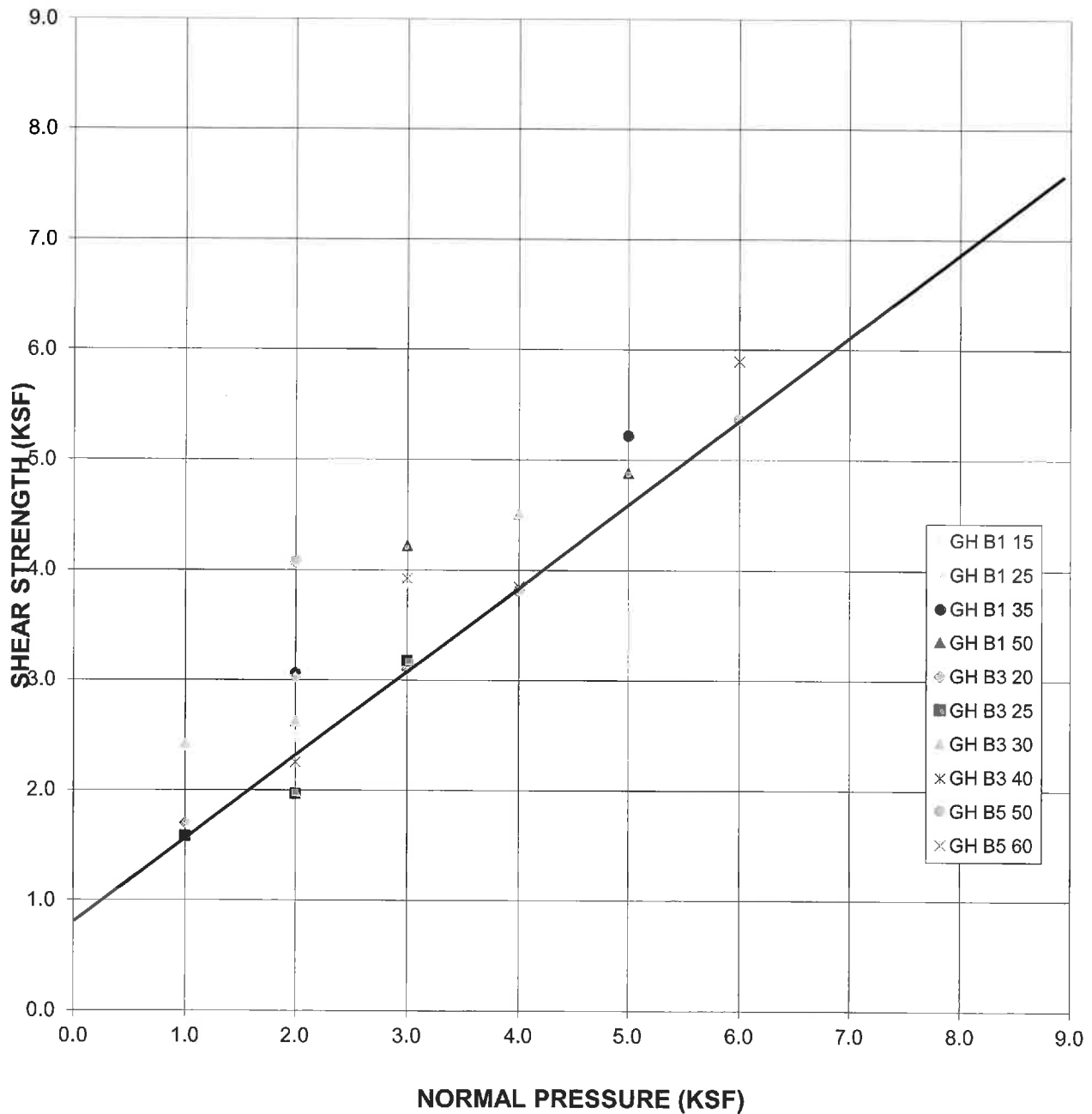



**BYER
GEOTECHNICAL
INC.**

1461 E. CHEVY CHASE DRIVE, SUITE 200 GLENDALE, CA 91206
(818) 549-9959 Tel (818) 543-3747 FAX

SHEAR DIAGRAM #4

BG: 21898 CONSULTANT: JWB
CLIENT: HARVARD-WESTLAKE

EARTH MATERIAL: BEDROCK - SOUTHERN UNIT

Phi Angle = 36 degrees
Cohesion = 540 psf

Average Moisture Content
Average Dry Density (pcf)
Average Percent Saturation #DIV/0!

DIRECT SHEAR TEST - ASTM D-3080 (ULTIMATE VALUES)

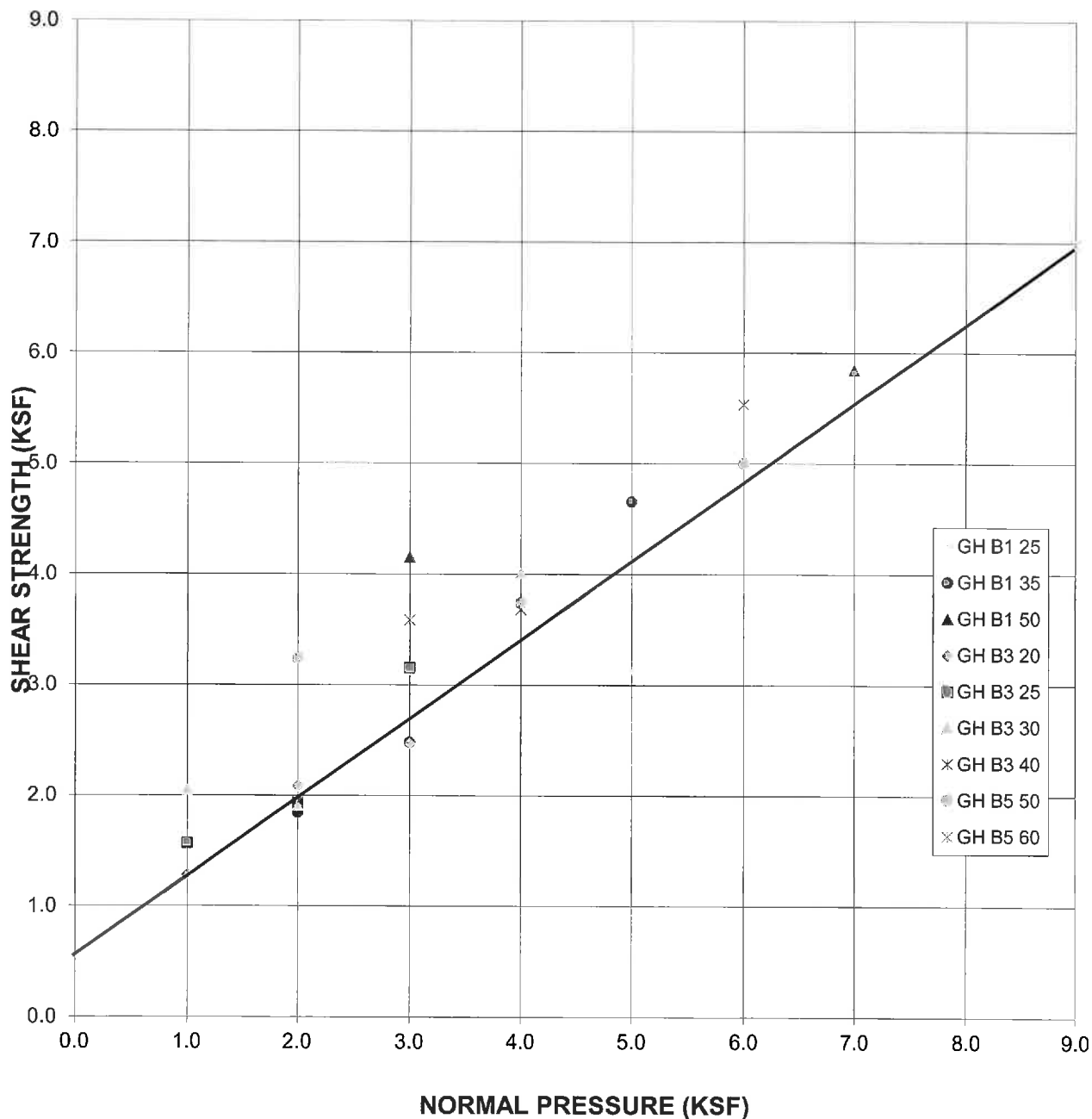



**BYER
GEOTECHNICAL
INC.**

1461 E. CHEVY CHASE DRIVE, SUITE 200 GLENDALE, CA 91206
(818) 549-9959 Tel (818) 543-3747 FAX

SHEAR DIAGRAM #5

BG: 21898 CONSULTANT: JWB
CLIENT: HARVARD-WESTLAKE
EARTH MATERIAL: WEAK BEDROCK
PLANE B3-23.5'

FROM GROVER-HOLLINGSWORTH SHEAR DIAGRAM B-7

RESIDUAL SHEAR STRENGTH

Phi Angle = 19.5 degrees
Cohesion = 540 psf

PEAK SHEAR STRENGTH

Phi Angle = 23 degrees
Cohesion = 700 psf

DIRECT SHEAR TEST - ASTM D-3080

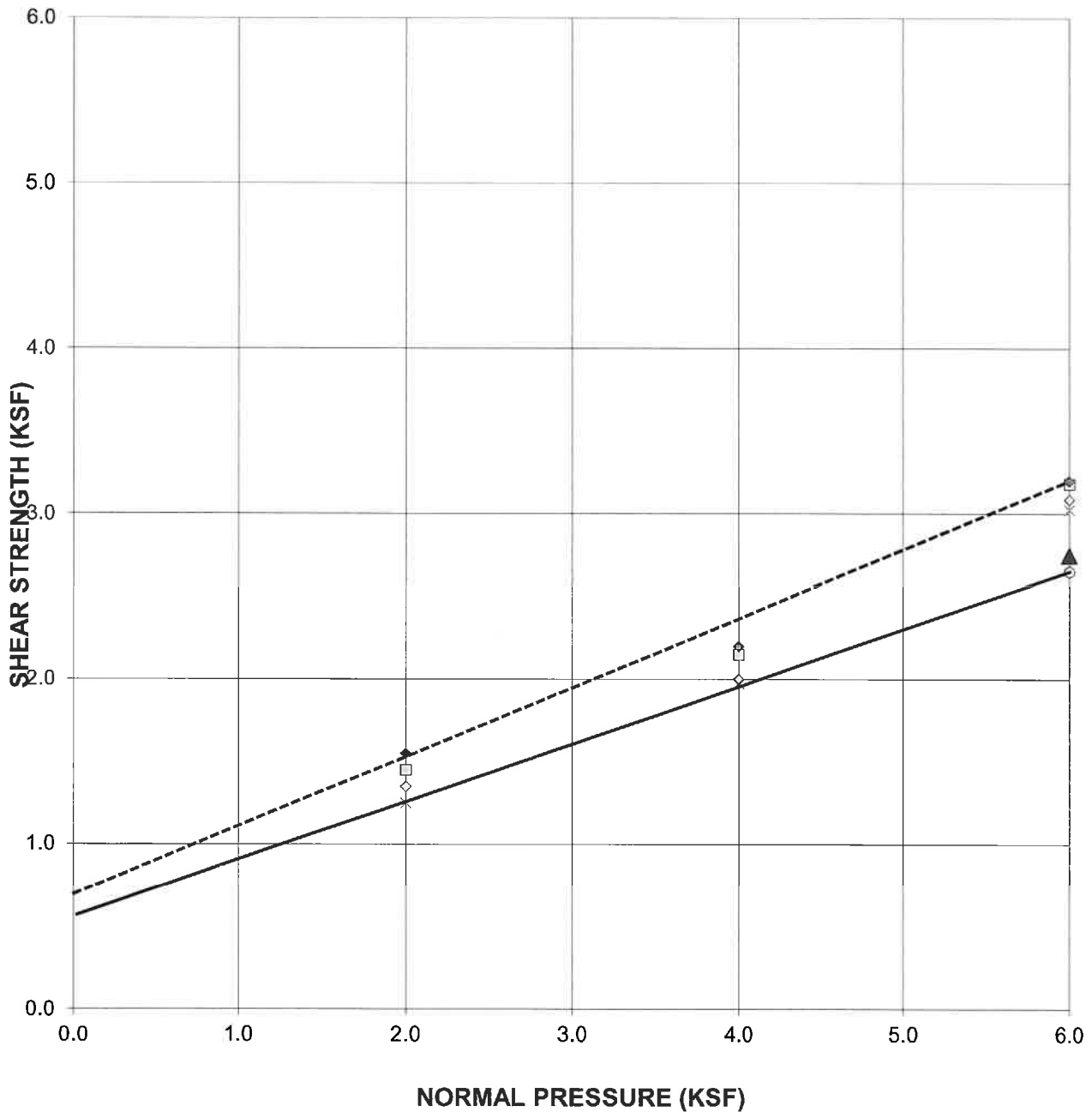



**BYER
GEOTECHNICAL
INC.**

1461 E. CHEVY CHASE DRIVE, SUITE 200 GLENDALE, CA 91206
(818) 549-9959 Tel (818) 543-3747 FAX

SHEAR DIAGRAM #6

BG: 21898 CONSULTANT: JWB
CLIENT: HARVARD-WESTLAKE

EARTH MATERIAL: ALLUVIUM

Phi Angle = 30 degrees
Cohesion = 150 psf

DIRECT SHEAR TEST - ASTM D-3080

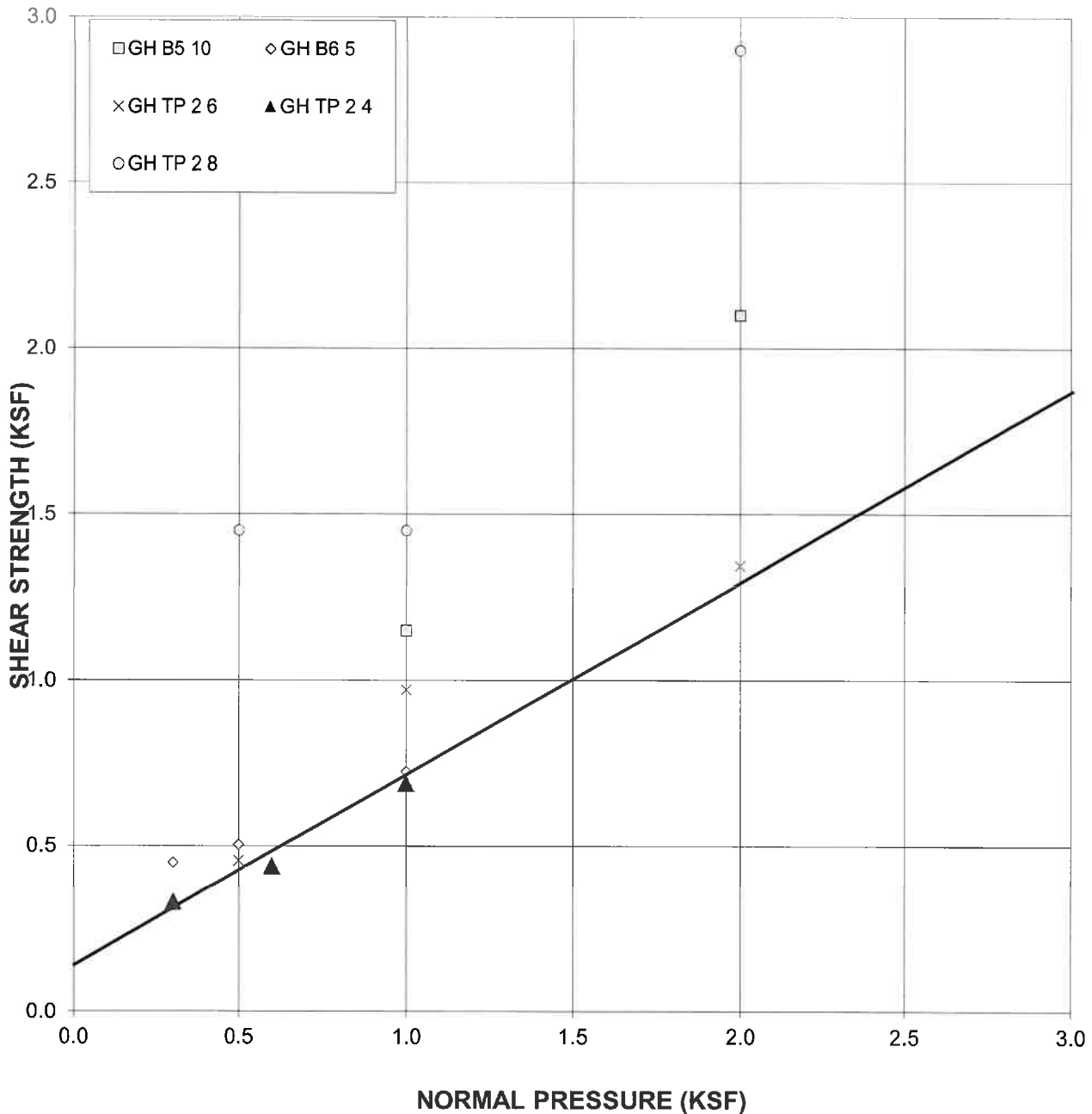



**BYER
GEOTECHNICAL
INC.**

1461 E. CHEVY CHASE DRIVE, SUITE 200 GLENDALE, CA 91206
(818) 549-9959 Tel (818) 543-3747 FAX

CONSOLIDATION DIAGRAM #1

BG: 21898 CONSULTANT: JWB
CLIENT: HARVARD WESTLAKE

Earth Material: ALLUVIUM
Sample Location: GH B5-5'
Dry Weight (pcf): 49.6
Initial Moisture: 68.8%
Initial Saturation: 81.0%
Total Saturated Weight (pcf): 83.7

Water Added at (psf): 1228
Specific Gravity: 2.44
Initial Void Ratio: 2.07
Compression Index (Cc): 0.311
Recompression Index (Cr): 0.042

CONSOLIDATION DIAGRAM

LOG PRESSURE (PSF)

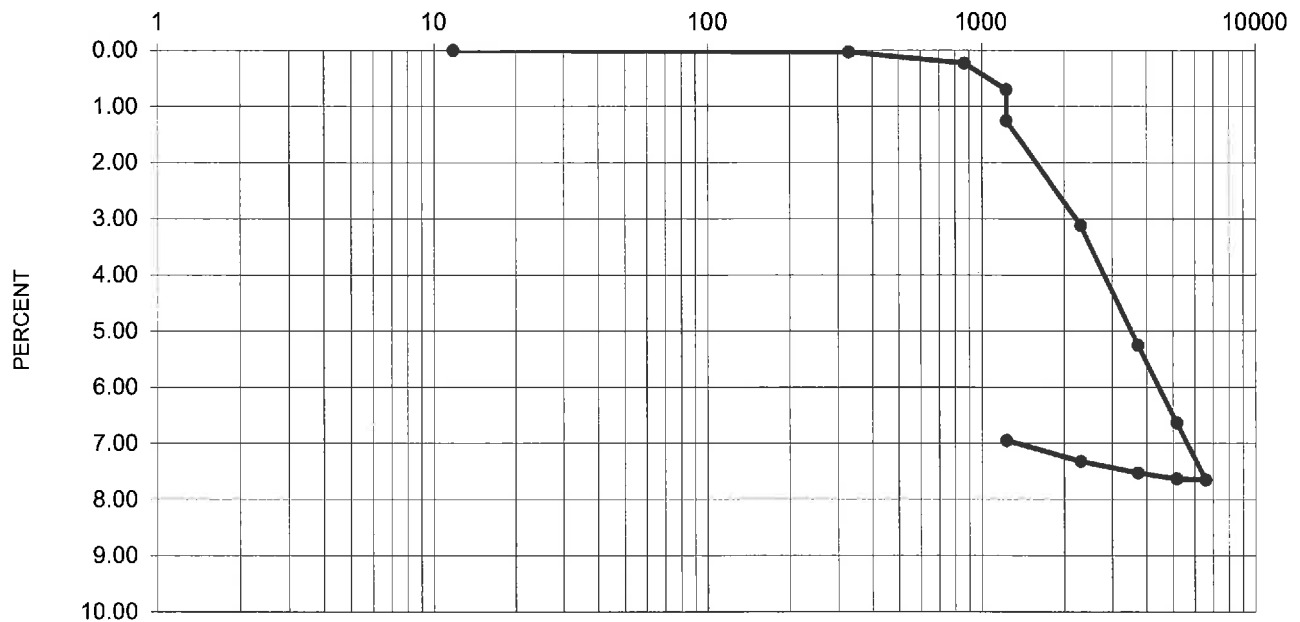



**BYER
GEOTECHNICAL
INC.**

1461 E. CHEVY CHASE DRIVE, SUITE 200 GLENDALE, CA 91206
(818) 549-9959 Tel (818) 543-3747 FAX

CONSOLIDATION DIAGRAM #2

BG: **21898** CONSULTANT: **JWB**
CLIENT: **HARVARD WESTLAKE**

Earth Material: ALLUVIUM
Sample Location: GH B5-15'
Dry Weight (pcf): 69.4
Initial Moisture: 29.2%
Initial Saturation: 59.7%
Total Saturated Wt (pcf): 89.7

Water Added at (psf): 1225
Specific Gravity: 2.44
Initial Void Ratio: 1.19
Compression Index (Cc): 0.072
Recompression Index (Cr): 0.031

CONSOLIDATION DIAGRAM

LOG PRESSURE (PSF)

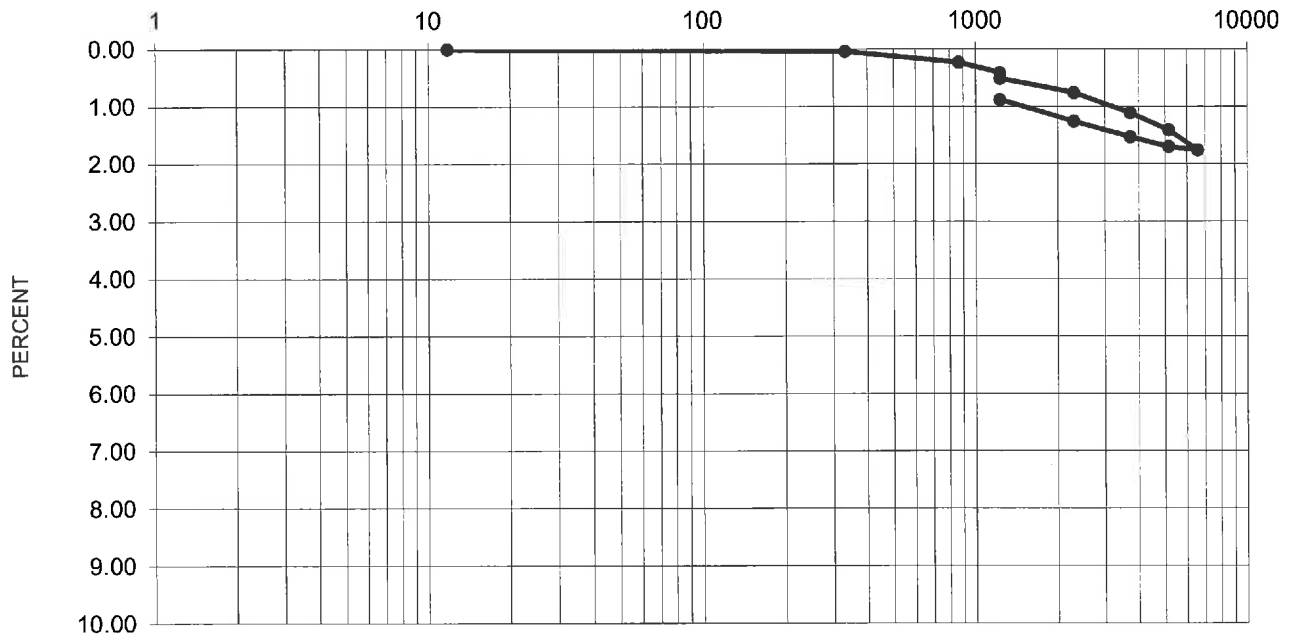



**BYER
GEOTECHNICAL
INC.**

1461 E. CHEVY CHASE DRIVE, SUITE 200 GLENDALE, CA 91206
(818) 549-9959 Tel (818) 543-3747 FAX

CONSOLIDATION DIAGRAM #3

BG: 21898 CONSULTANT: JWB

CLIENT: HARVARD WESTLAKE

Earth Material: ALLUVIUM
Sample Location: GH B5-25'
Dry Weight (pcf): 78.1
Initial Moisture: 21.3%
Initial Saturation: 54.7%
Total Saturated Wt (pcf): 94.7

Water Added at (psf): 1240
Specific Gravity: 2.44
Initial Void Ratio: 0.95
Compression Index (Cc): 0.105
Recompression Index (Cr): 0.029

CONSOLIDATION DIAGRAM
LOG PRESSURE (PSF)

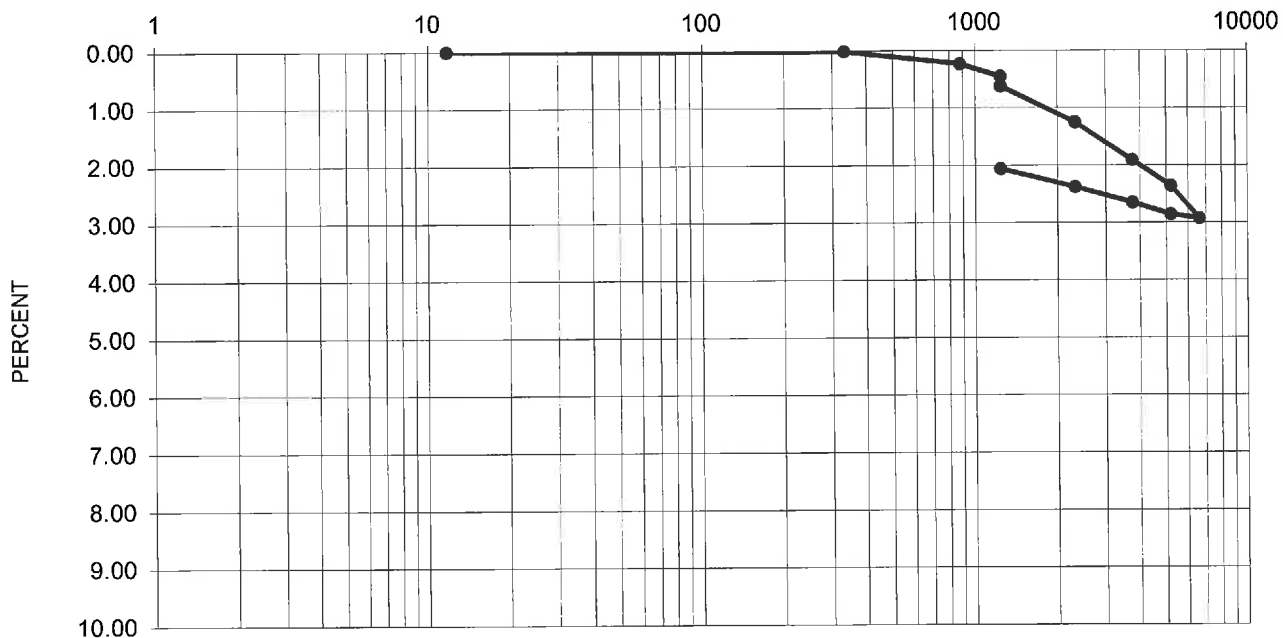

SUMMARY OF CORROSION TEST RESULTS

PROJECT NAME: Harvard

EGLAB JOB NO.: 14-249-010

PROJECT NO.: 21898

CLIENT: Byer Geotechnical, Inc.

DATE: 5/2/2014

Summarized By: JT

BORING NO.	SAMPLE NO.	DEPTH (ft)	pH CalTrans 643	Chloride Content CalTrans 422 (ppm)	Sulfate Content CalTrans 417 (% by weight)	Minimum Resistivity CalTrans 643 (ohm-cm)
N/A	Alluvium	N/A	7.52	980	0.001	1,200
TP-2	Siltstone	N/A	7.41	325	0.036	630

USGS Design Maps Summary Report

User-Specified Input

Report Title BG 21898
 Fri March 14, 2014 19:03:42 UTC

Building Code Reference Document ASCE 7-10 Standard
 (which utilizes USGS hazard data available in 2008)

Site Coordinates 34.1388°N, 118.414°W

Site Soil Classification Site Class C - "Very Dense Soil and Soft Rock"

Risk Category I/II/III



USGS-Provided Output

$S_s = 2.374 \text{ g}$	$S_{MS} = 2.374 \text{ g}$	$S_{DS} = 1.583 \text{ g}$
$S_1 = 0.825 \text{ g}$	$S_{M1} = 1.073 \text{ g}$	$S_{D1} = 0.715 \text{ g}$

For information on how the S_s and S_1 values above have been calculated from probabilistic (risk-targeted) and deterministic ground motions in the direction of maximum horizontal response, please return to the application and select the "2009 NEHRP" building code reference document.

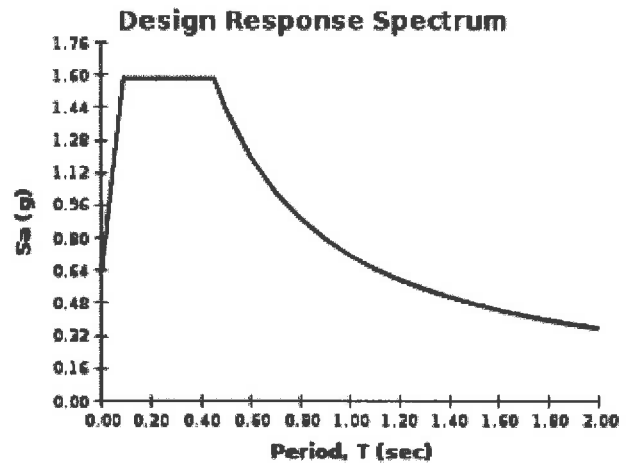
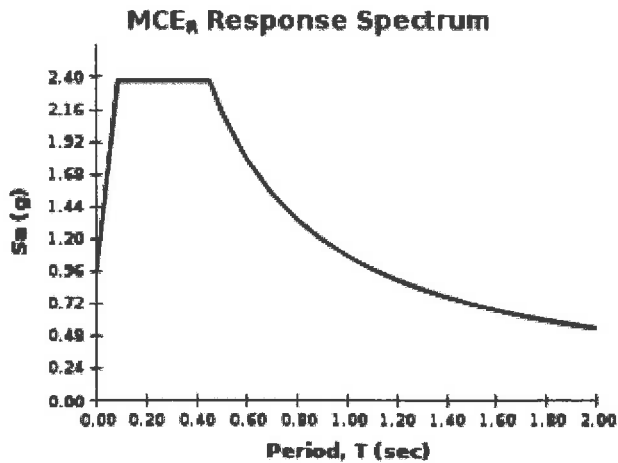

For PGA_M , T_L , C_{RS} , and C_{R1} values, please [view the detailed report](#).

USGS Design Maps Summary Report

User-Specified Input

Report Title BG 21898
Thu January 23, 2014 21:24:48 UTC

Building Code Reference Document ASCE 7-05 Standard
(which utilizes USGS hazard data available in 2002)

Site Coordinates 34.1388°N, 118.414°W

Site Soil Classification Site Class C - "Very Dense Soil and Soft Rock"

Occupancy Category I/II/III



USGS-Provided Output

$S_s = 1.500\text{ g}$	$S_{MS} = 1.500\text{ g}$	$S_{DS} = 1.000\text{ g}$
$S_1 = 0.600\text{ g}$	$S_{M1} = 0.780\text{ g}$	$S_{D1} = 0.520\text{ g}$

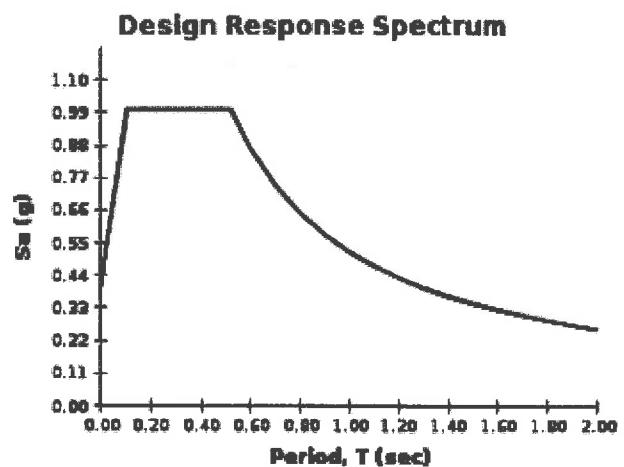
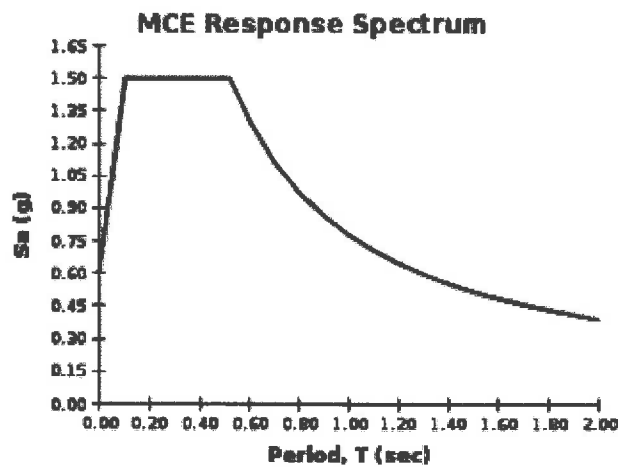

Although this information is a product of the U.S. Geological Survey, we provide no warranty, expressed or implied, as to the accuracy of the data contained therein. This tool is not a substitute for technical subject-matter knowledge.

Seismic Slope Stability Screening Analysis

Reference: Southern California Earthquake Center (SCEC), 2002, Recommended Procedures for Implementation of DMG Special Publication 117 Guidelines for Analyzing and Mitigating Landslide Hazards in California.



BYER
GEOTECHNICAL
INC.

Input Parameters:

Maximum Horizontal Acceleration	MHAr (g) = 0.583
Moment Magnitude from Deaggregation	Mw = 6.58
Modal Distance from Deaggregation	r (km) = 5.8

Calculations:

Non-Linear Response Factor	NRF = 0.8705	Eq. 11.3 (Valid for $0.1 < \text{MHAr} < 0.8$)
	$\ln(D_{5-95}) =$	Eq. 10.1a (for $r > 10$ km)
	$\ln(D_{5-95}) =$	Eq. 10.1b (for $r \leq 10$ km)
Median Duration of Shaking	D_{5-95} (sec.) = 9.8984	

For Threshold Newmark Displacement, u, of 5 cm:

Median Seismicity Factor	$f_{eq} =$	Eq. 11.2
Horizontal Seismic Coefficient	k_{eq} (u = 5 cm) = 0.2733	Eq. 11.1. Use this in pseudostatic slope analysis. If FS > 1, the site passes the screen.

For Threshold Newmark Displacement, u, of 15 cm:

Median Seismicity Factor	$f_{eq} =$	Eq. 11.2
Horizontal Seismic Coefficient	k_{eq} (u = 15 cm) = 0.2036	Eq. 11.1. Use this in pseudostatic slope analysis. If FS > 1, the site passes the screen.

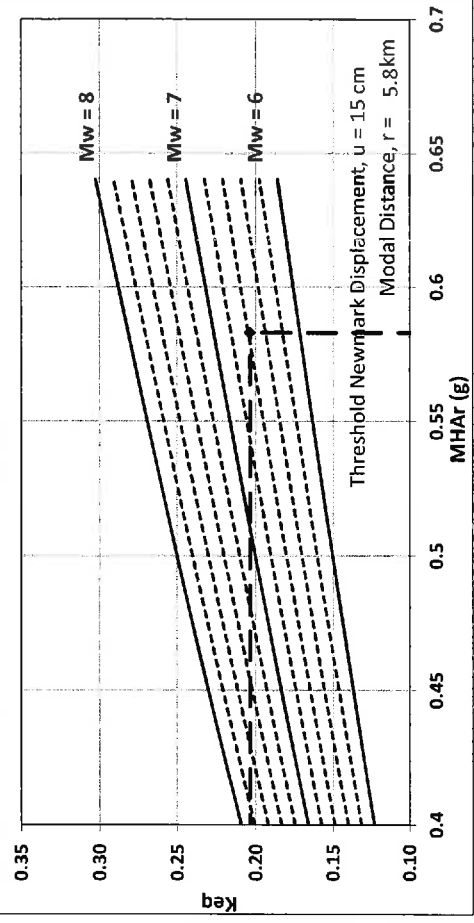
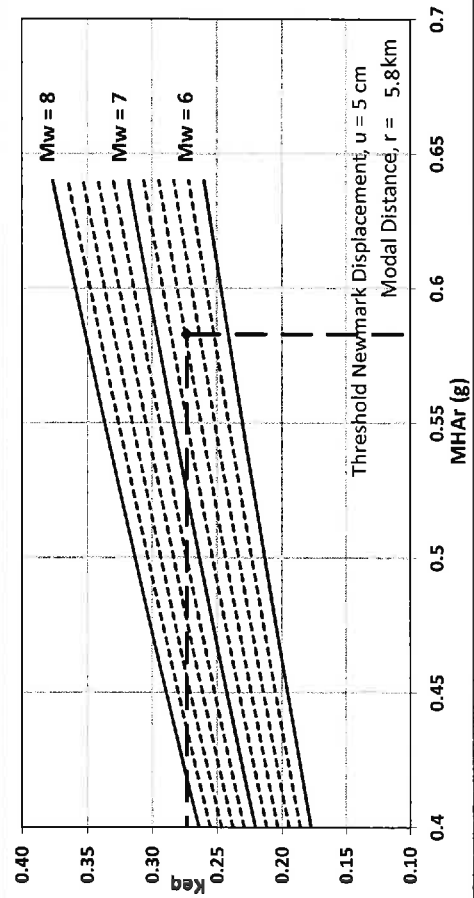

SEISMIC SOURCES
EZ-FRISK V7.62



DETERMINISTIC CALCULATION
OF PEAK GROUND ACCELERATION BASED ON DIGITIZED FAULT DATA

BG: 21898

CLIENT: Harvard Westlake School

ENGINEER: RSB

PROJECT DESCRIPTION: Proposed Parking Structure

SITE COORDINATES: LATITUDE: 34.1388
 LONGITUDE: -118.4140

SEARCH RADIUS: 100 km

ATTENUATION RELATIONS: CHIOU-YOUNGS (2007) NGA USGS 2008 MRC
 BOORE-ATKINSON (2008) NGA USGS 2008 MRC
 CAMPBELL-BOZORGNIA (2008) NGA USGS 2008 MRC

SEISMIC SOURCE SUMMARY
DETERMINISTIC SITE PARAMETERS

FAULT NAME	APPROXIMATE DISTANCE		MAXIMUM EARTHQUAKE MAGNITUDE	PEAK GROUND ACCELERATION
	(km)	(mi)	(Mw)	(g)
Hollywood	5.4	3.3	6.7	1.065
Santa Monica	5.9	3.7	7.4	1.440
Verdugo	10.3	6.4	6.9	0.526
Newport-Inglewood	10.9	6.7	7.5	0.577
Elysian Park (Upper)	11.6	7.2	6.7	0.535
Puente Hills (LA)	13.4	8.3	7.0	0.533
Puente Hills	14.8	9.2	7.1	0.535
Malibu Coast	15.5	9.7	7.0	0.441
Sierra Madre (San Fernando)	16.8	10.4	6.7	0.350
Sierra Madre Connected	16.8	10.4	7.3	0.433
Anacapa-Dume	17.5	10.9	7.2	0.468
Northridge	17.5	10.9	6.9	0.610
Raymond	17.7	11.0	6.8	0.350
Sierra Madre	18.2	11.3	7.2	0.395
Santa Susana, alt 1	21.1	13.1	6.9	0.316
Palos Verdes	22.9	14.2	7.3	0.335

FAULT NAME	APPROXIMATE DISTANCE		MAXIMUM EARTHQUAKE MAGNITUDE	PEAK GROUND ACCELERATION
	(km)	(mi)	(Mw)	(g)
Palos Verdes Connected	22.9	14.2	7.7	0.390
San Gabriel	23.4	14.6	7.3	0.330
Puente Hills (Santa Fe Springs)	26.6	16.5	6.7	0.309
Holser, alt 1	30.8	19.1	6.8	0.244
Simi-Santa Rosa	31.8	19.8	6.9	0.221
Clamshell-Sawpit	36.6	22.8	6.7	0.186
Elsinore	37.3	23.2	7.9	0.294
Oak Ridge Connected	37.4	23.3	7.4	0.275
Oak Ridge (Onshore)	39.1	24.3	7.2	0.253
Puente Hills (Coyote Hills)	41.6	25.9	6.9	0.204
San Cayetano	46.0	28.6	7.2	0.187
San Jose	49.6	30.8	6.7	0.134
Southern San Andreas	53.2	33.1	8.2	0.266
Chino	57.5	35.7	6.8	0.118
Cucamonga	60.8	37.8	6.7	0.109
Santa Ynez (East)	63.9	39.7	7.2	0.136
Santa Ynez Connected	64.1	39.9	7.4	0.150
San Joaquin Hills	66.4	41.3	7.1	0.140
Ventura-Pitas Point	70.6	43.9	7.0	0.122
Pitas Point Connected	70.6	43.9	7.3	0.239
Imp Extensional Gridded, Char, Normal	56.6	35.2	7.0	0.118
Imp Extensional Gridded, Char, Strike Slip	56.6	35.2	7.0	0.146
Imp Extensional Gridded, GR, Normal	56.9	35.4	7.0	0.118
Imp Extensional Gridded, GR, Strike Slip	56.9	35.4	7.0	0.145
Oak Ridge (Offshore)	75.7	47.1	7.0	0.103
Mission Ridge-Arroyo Parida-Santa Ana	76.2	47.4	6.9	0.096
Channel Islands Thrust	79.4	49.3	7.3	0.138
Santa Cruz Island	79.8	49.6	7.2	0.106
San Jacinto	79.9	49.7	7.9	0.157
Red Mountain	84.8	52.7	7.4	0.115
Garlock	87.4	54.3	7.7	0.132
Pleito	88.8	55.2	7.1	0.092
Cleghorn	89.4	55.6	6.8	0.073

49 Faults found within a 100 km Search Radius.

Closest Fault to the Site: Hollywood

Distance = 5.4 km (3.3mi)

Largest Peak Ground Acceleration: 1.44 g

The San Andreas Fault is Located Aproximately 53.2 km (33.1 mi)

Site-Specific Ground Motion Analysis

BG: <u>21898</u>	Client: <u>Harvard Westlake School</u>	Date: <u>3/14/14</u>
Project Description: <u>Proposed Parking Structure</u>		Engineer: <u>RSB</u>

Ss (0.2s) =	2.374	Latitude:	34.1388	Periods (seconds):		80% of Sections. 11.4.3 & 11.4.4	RESULTS Design Values ASCE 7-05 (Section 21.4)	
S1 (1s) =	0.825	Longitude:	-118.4140	T _o =	0.090			
Fa =	1.00	Site Class:	C	T _s =	0.452			
Fv =	1.30			T _L =	8			
SMs =	2.374			S _{MS} =	2.462	>	1.899	2.462
SM1 =	1.073			S _{M1} =	1.001	>	0.858	1.001
SDs =	1.583			S _{DS} =	1.641	>	1.266	1.641
SD1 =	0.715			S _{D1} =	0.667	>	0.572	0.667

Fundamental Period	Probabilistic MRC Seismic Response Spectrum (DSA 09-01)*	Probabilistic Seismic Response Spectrum (Section 11.4.5, ASCE 7-10)	84 th Percentile of Deterministic MRC Seismic Response Spectrum (DSA 09-01)*	Deterministic Lower Limit on Prob. Response Spectrum (ASCE 7-10, Section 21.2.2)	Site Specific MRC Spectral Response Acceleration (ASCE 7-10, Section 21.2.3)	80% of Probabilistic Response Spectrum (ASCE 7-10, Section 21.3)	Design Response Spectrum (ASCE 7-10, Section 21.3)
T (sec)	Sa (g)	Sa (g)	Sa (g)	Sa (g)	Sa (g)	Sa (g)	Sa (g)
0.0	1.0620	0.6331	1.4400	1.500	1.062	0.506	0.708
0.1	2.0630	1.5827	2.7820	1.500	2.063	1.266	1.375
0.2	2.4610	1.5827	3.4500	1.500	2.461	1.266	1.641
0.3	2.2140	1.5827	3.2380	1.500	2.214	1.266	1.476
0.4	2.0150	1.5827	2.9360	1.500	2.015	1.266	1.343
0.5	1.7690	1.4300	2.6540	1.500	1.769	1.144	1.179
0.6	1.5170	1.1917	2.3440	1.300	1.517	0.953	1.011
0.7	1.3440	1.0214	2.1100	1.114	1.344	0.817	0.896
0.8	1.2050	0.8938	1.8970	0.975	1.205	0.715	0.803
0.9	1.0910	0.7944	1.7010	0.867	1.091	0.636	0.727
1.0	1.0010	0.7150	1.5390	0.780	1.001	0.572	0.667
1.1	0.8935	0.6500	1.3740	0.709	0.894	0.520	0.596
1.2	0.8078	0.5958	1.2360	0.650	0.808	0.477	0.539
1.3	0.7375	0.5500	1.1170	0.600	0.738	0.440	0.492
1.4	0.6767	0.5107	1.0140	0.557	0.677	0.409	0.451
1.5	0.6216	0.4767	0.9252	0.520	0.622	0.381	0.414
1.6	0.5697	0.4469	0.8392	0.488	0.570	0.358	0.380
1.7	0.5262	0.4206	0.7650	0.459	0.526	0.336	0.351
1.8	0.4882	0.3972	0.7005	0.433	0.488	0.318	0.325
1.9	0.4536	0.3763	0.6442	0.411	0.454	0.301	0.302
2.0	0.4241	0.3575	0.5952	0.390	0.424	0.286	0.286
3.0	0.2525	0.2383	0.3310	0.260	0.253	0.191	0.191
4.0	0.1765	0.1788	0.2227	0.195	0.177	0.143	0.143
5.0	0.1398	0.1430	0.1834	0.156	0.140	0.114	0.114
6.0	0.1135	0.1192	0.1430	0.130	0.114	0.095	0.095
7.0	0.0963	0.1021	0.1155	0.111	0.096	0.082	0.082
8.0	0.0802	0.0894	0.0949	0.098	0.080	0.072	0.072

* The Probabilistic and Deterministic Seismic Response Spectra are Based on the Maximum Rotated Component (MRC) of Ground Motion.

References: - American Society of Civil Engineers (ASCE), 2010, Minimum Design Loads for Buildings and Other Structures, Standard ASCE/SEI 7-10, Chapter 21.

SEISMIC RESPONSE SPECTRA

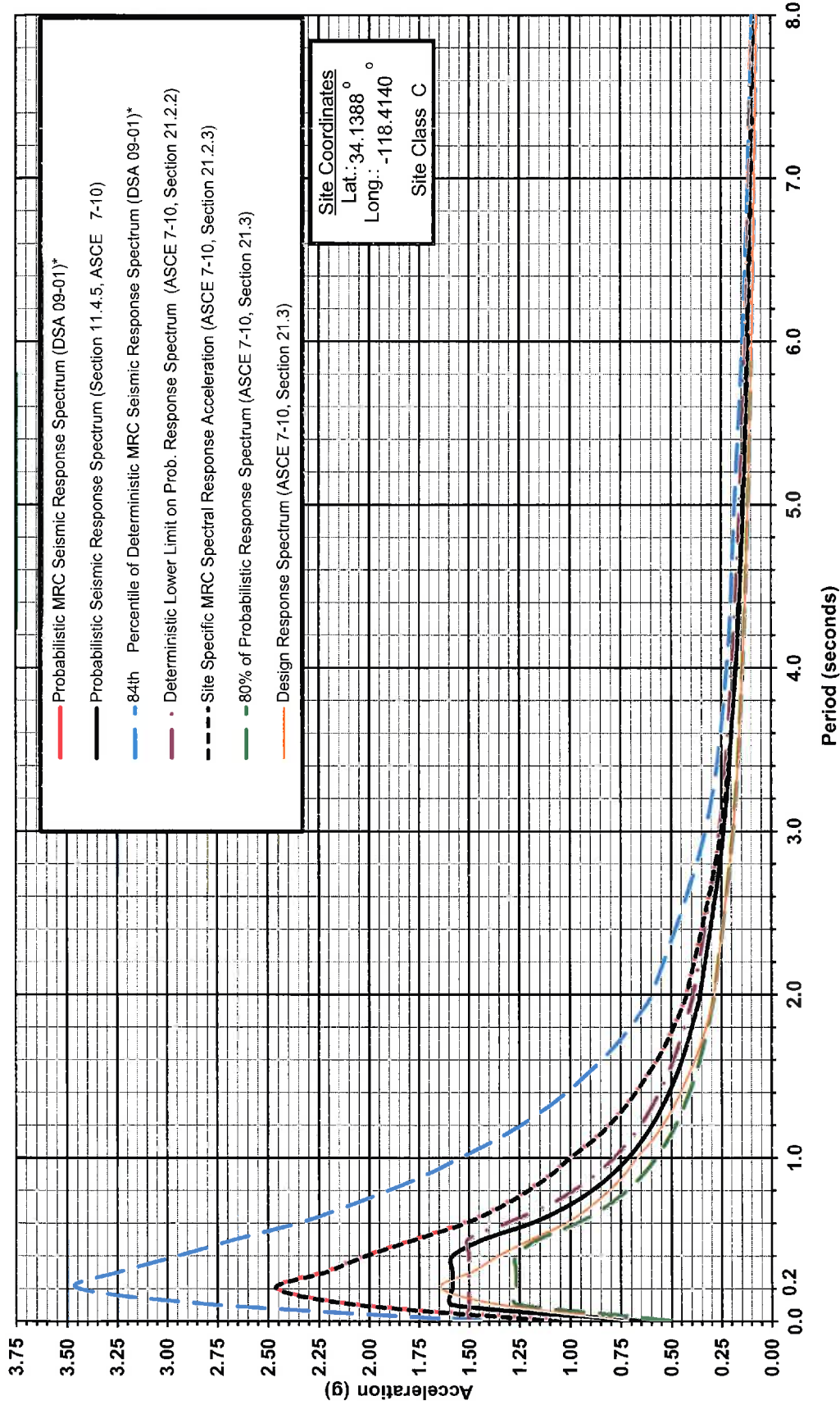

**BYER
 GEOTECHNICAL
 INC.**

1461 E. CHEVY CHASE DRIVE, #200, GLENDALE, CA 91206
 tel 818.549.9959
 fax 818.543.3747

SITE-SPECIFIC SEISMIC RESPONSE SPECTRA	
Proposed Parking Structure	
BG: 21898	Client: Harvard Westlake School
Engineer: RSB	Date: March 17, 2014

**PSH Deaggregation on NEHRP C soil
HW School 118.414° W, 34.139 N.**

Peak Horiz. Ground Accel. ≥ 0.4893 g
 Ann. Exceedance Rate .211E-02. Mean Return Time 475 years
 Mean (R, M, ϵ_0) 11.3 km, 6.69, 0.52
 Modal $(R, M, \epsilon_0) = 5.8$ km, 6.58, -0.07 (from peak R, M bin)
 Modal $(R, M, \epsilon^*) = 5.7$ km, 6.58, 0 to 1 sigma (from peak R, M, ϵ bin)
 Binning: DeltaR 10. km, deltaM=0.2, Delta ϵ =1.0

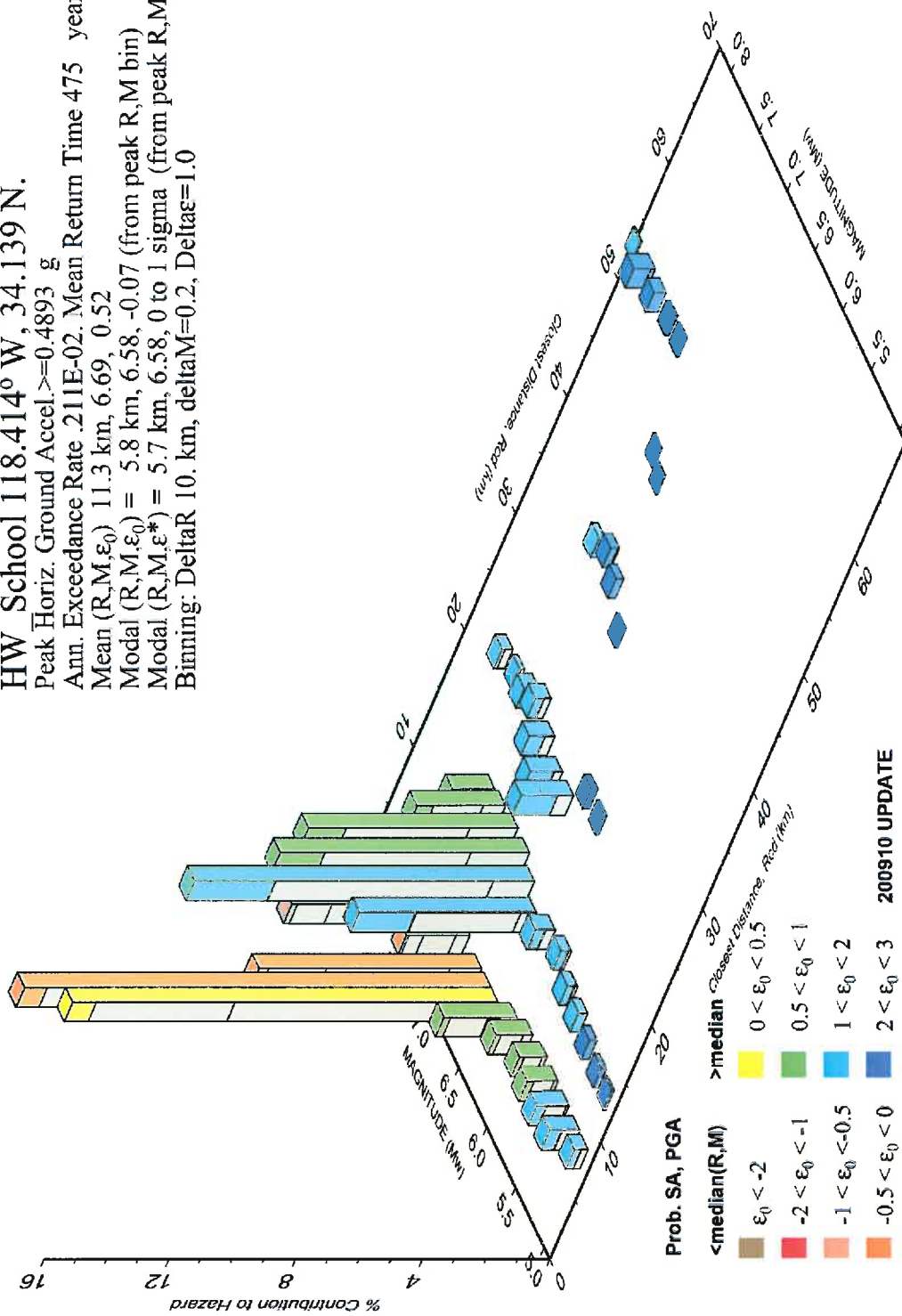

REFERENCE: USGS, 2009, Deaggregation of Seismic Hazard at One Period of Spectral Acceleration, Data from USGS National Seismic Hazards Mapping Project, <https://geohazards.usgs.gov/deaggint/2008/>.

GMT 2014 Mar 17 19:01:11 Distance (R), magnitude (M), epsilon (ϵ_0) deaggregation for a site on soil with average vs=550. mis top 30 m. USGS CGHT PSHA2008 UPDATE Bins with lt 0.05% contrib. omitted



1461 E. CHEVY CHASE DRIVE, #200, GLENDALE, CA 91206
 tel 818.549.9959 fax 818.543.3747

SEISMIC HAZARD DEAGGREGATION CHART
 (Probability of Exceedance = 10% in 50 Years)

BG: 21898 CLIENT: HARVARD WESTLAKE SCHOOL
 ENGINEER: RIZ



**BYER
GEOTECHNICAL
INC.**

1461 East Chevy Chase Drive, Suite 200, Glendale, CA 91206
tel 818.549.9959 fax 818.543.3747

SURFICIAL STABILITY

BG: **21898** CONSULTANT: **RIZ**
CLIENT: **HARVARD WESTLAKE**

CALCULATION SHEET #

CALCULATE THE SURFICIAL STABILITY OF THE EARTH MATERIAL USING THE INFINITE SLOPE ANALYSIS WITH PARALLEL SEEPAGE. THIS METHOD WAS RECOMMENDED BY THE ASCE AND THE BUILDING AND SAFETY ADVISORY COMMITTEE (8/16/78). MODIFIED FROM SKEMPTON & DeLORY, 1957.

CALCULATION PARAMETERS

EARTH MATERIAL: SOIL

COHESION: 360 psf

PHI ANGLE: 24 degrees

DENSITY: 120 pcf

SHEAR DIAGRAM: JBG

SLOPE ANGLE: 34 degrees

SATURATION DEPTH (t): 3.0 feet

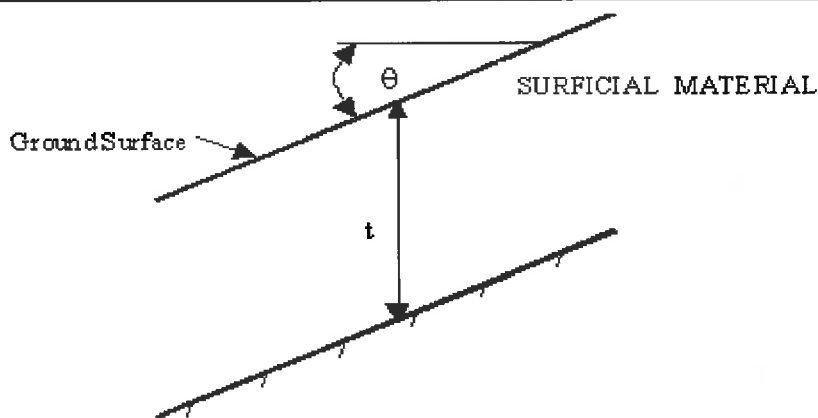

$$FS = \frac{C + (\gamma_{soil} - \gamma_{water}) \cdot t \cdot \cos^2 \theta \tan \Phi}{\gamma_{soil} \cdot t \cdot \cos \Phi \sin \Phi}$$

SAFETY FACTOR = 2.47

CONCLUSIONS:

THE CALCULATION INDICATES THAT EXISTING ASCENDING SLOPES BLANKETED BY SOIL AS STEEP AS 1.5:1 WILL BE SURFICIALLY STABLE.



**BYER
GEOTECHNICAL
INC.**

1461 East Chevy Chase Drive, Suite 200, Glendale, CA 91206
tel 818.549.9959 fax 818.543.3747

PASSIVE EARTH PRESSURE

BG: 21898 CONSULT: RIZ
CLIENT: HARVARD-WESTLAKE

CALCULATION SHEET #

USE RANKINE'S METHOD TO CALCULATE THE PASSIVE EARTH PRESSURE. USE THE PROCEDURE IN NAVFAC DM-7, 1982, (p 7.2-21, Figure 2).

CALCULATION PARAMETERS

EARTH MATERIAL:	BEDROCK (SOUTH)	SAFETY FACTOR (fs):	1.5
SHEAR DIAGRAM:	3	INITIAL SEARCH DEPTH:	1
COHESION:	540 psf	FINAL SEARCH DEPTH:	10
PHI ANGLE:	36 degrees	LIMIT PASSIVE (Y OR N):	Y
DENSITY:	115 pcf	MAXIMUM PASSIVE:	6,000.0 pounds
		Cd (C/fs):	360.0 psf
		PhiD = atan(tan(phi)/fs) =	25.8 degrees

FOOTING DEPTH (feet)	TOTAL PASSIVE FORCE Pp (pounds)	PASSIVE EARTH PRESSURE AT DEPTH - SigmaP (psf)	INCREASE IN PASSIVE EARTH PRESSURE WITH EMBEDMENT DEPTH (psf/f)
1	1,295.1	1,441.5	1,441.5
2	2,883.0	1,734.2	292.7
3	4,763.6	2,027.0	292.7
4	6,937.0	2,319.7	292.7
5	9,403.0	2,612.5	292.7
6	12,161.9	2,905.2	292.7
7	15,213.5	3,198.0	292.7
8	18,557.8	3,490.7	292.7
9	22,194.9	3,783.4	292.7
10	26,124.7	4,076.2	292.7

CONCLUSIONS:

THE CALCULATED RANKINE PASSIVE EARTH PRESSURE FOR A LEVEL SURFACE IS SHOWN IN THE TABLE. THE DISTRIBUTION OF PASSIVE EARTH PRESSURE IS TRAPEZOIDAL.



**BYER
GEOTECHNICAL
INC.**

1461 East Chevy Chase Drive, Suite 200, Glendale, CA 91206
tel 818.549.9959 fax 818.543.3747

RETAINING WALL

BG: **21898** CONSULTANT: **JWB**
CLIENT: **HARVARD-WESTLAKE**

CALCULATION SHEET #

CALCULATE THE DESIGN MINIMUM EQUIVALENT FLUID PRESSURE (EFP) FOR RETAINING WALLS. THE WALL HEIGHT, BACKSLOPE AND SURCHARGE CONDITIONS ARE LISTED BELOW. ASSUME THE BACKFILL IS SATURATED WITH NO EXCESS HYDROSTATIC PRESSURE. USE THE MONONOBE-OKABE METHOD FOR SEISMIC FORCES.

CALCULATION PARAMETERS

EARTH MATERIAL:	BEDROCK (SOUTH)	WALL HEIGHT	18 feet
SHEAR DIAGRAM:	4	BACKSLOPE ANGLE:	26.5 degrees
COHESION:	825 psf	SURCHARGE:	0 pounds
PHI ANGLE:	37 degrees	SURCHARGE TYPE:	U Uniform
DENSITY	115 pcf	INITIAL FAILURE ANGLE:	30 degrees
SAFETY FACTOR:	1.5	FINAL FAILURE ANGLE:	70 degrees
WALL FRICTION	0 degrees	INITIAL TENSION CRACK:	1 feet
CD (C/FS):	550.0 psf	FINAL TENSION CRACK:	30 feet
PHID = ATAN(TAN(PHI)/FS) =	26.7 degrees		
HORIZONTAL PSEUDO STATIC SEISMIC COEFFICIENT (k _h)		0 g	
VERTICAL PSEUDO STATIC SEISMIC COEFFICIENT (k _v)		0 g	

CALCULATED RESULTS

CRITICAL FAILURE ANGLE	58 degrees
AREA OF TRIAL FAILURE WEDGE	33.8 square feet
TOTAL EXTERNAL SURCHARGE	0.0 pounds
WEIGHT OF TRIAL FAILURE WEDGE	3886.6 pounds
NUMBER OF TRIAL WEDGES ANALYZED	1230 trials
LENGTH OF FAILURE PLANE	3.8 feet
DEPTH OF TENSION CRACK	15.8 feet
HORIZONTAL DISTANCE TO UPSLOPE TENSION CRACK	2.0 feet
CALCULATED HORIZONTAL THRUST ON WALL	194.1 pounds
CALCULATED EQUIVALENT FLUID PRESSURE	1.2 pcf
DESIGN EQUIVALENT FLUID PRESSURE	43.0 pcf

Conclusions:

THE CALCULATION INDICATES THAT THE PROPOSED RETAINING WALL TO A HEIGHT OF 18 FEET MAY BE DESIGNED FOR AN EQUIVALENT FLUID PRESSURE OF 43 POUNDS PER CUBIC FOOT.



**BYER
GEOTECHNICAL
INC.**

1461 East Chevy Chase Drive, Suite 200, Glendale, CA 91206
tel 818.549.9959 fax 818.543.3747

RETAINING WALL

BG: **21898** CONSULTANT: **JWB**
CLIENT: **HARVARD-WESTLAKE**

CALCULATION SHEET #

CALCULATE THE DESIGN MINIMUM EQUIVALENT FLUID PRESSURE (EFP) FOR RETAINING WALLS. THE WALL HEIGHT, BACKSLOPE AND SURCHARGE CONDITIONS ARE LISTED BELOW. ASSUME THE BACKFILL IS SATURATED WITH NO EXCESS HYDROSTATIC PRESSURE. USE THE MONONOBE-OKABE METHOD FOR SEISMIC FORCES.

CALCULATION PARAMETERS

EARTH MATERIAL:	BEDROCK (SOUTH)	WALL HEIGHT	18 feet
SHEAR DIAGRAM:	4	BACKSLOPE ANGLE:	26.5 degrees
COHESION:	825 psf	SURCHARGE:	0 pounds
PHI ANGLE:	37 degrees	SURCHARGE TYPE:	U Uniform
DENSITY	115 pcf	INITIAL FAILURE ANGLE:	30 degrees
SAFETY FACTOR:	1	FINAL FAILURE ANGLE:	70 degrees
WALL FRICTION	0 degrees	INITIAL TENSION CRACK:	1 feet
CD (C/FS):	825.0 psf	FINAL TENSION CRACK:	30 feet
PHID = $ATAN(TAN(PHI)/FS)$ =	37.0 degrees		
HORIZONTAL PSEUDO STATIC SEISMIC COEFFICIENT (k_h)		0.29 g	
VERTICAL PSEUDO STATIC SEISMIC COEFFICIENT (k_v)		0 g	

CALCULATED RESULTS

CRITICAL FAILURE ANGLE	55 degrees
AREA OF TRIAL FAILURE WEDGE	17.5 square feet
TOTAL EXTERNAL SURCHARGE	0.0 pounds
WEIGHT OF TRIAL FAILURE WEDGE	2016.5 pounds
NUMBER OF TRIAL WEDGES ANALYZED	1230 trials
LENGTH OF FAILURE PLANE	1.7 feet
DEPTH OF TENSION CRACK	17.1 feet
HORIZONTAL DISTANCE TO UPSLOPE TENSION CRACK	1.0 feet
CALCULATED HORIZONTAL THRUST ON WALL	32.2 pounds
	43.0

Conclusions:

THE CALCULATION INDICATES THAT THE PROPOSED RETAINING WALL TO A HEIGHT OF 18 FEET AND DESIGNED FOR AN EQUIVALENT FLUID PRESSURE OF 43 POUNDS PER CUBIC FOOT (THRUST=6,966 POUNDS) DOES NOT REQUIRE ADDITIONAL FORCE FOR SEISMIC DESIGN.



**BYER
GEOTECHNICAL
INC.**

1461 East Chevy Chase Drive, Suite 200, Glendale, CA 91206
tel 818.549.9959 fax 818.543.3747

TEMPORARY EXCAVATION HEIGHT

BG: **21898** CONSULTANT: **RIZ**
CLIENT: **HARVARD-WESTLAKE**

CALCULATION SHEET #

CALCULATE THE HEIGHT TO WHICH TEMPORARY EXCAVATIONS ARE STABLE (NEGATIVE THRUST). THE EXCAVATION HEIGHT AND BACKSLOPE AND SURCHARGE CONDITIONS ARE LISTED BELOW. ASSUME THE EARTH MATERIAL IS SATURATED WITH NO EXCESS HYDROSTATIC PRESSURE.

CALCULATION PARAMETERS

EARTH MATERIAL: BEDROCK (SOUTH)	WALL HEIGHT:	10 feet
SHEAR DIAGRAM: 3	BACKSLOPE ANGLE:	45 degrees
COHESION: 540 psf	SURCHARGE:	0 pounds
PHI ANGLE: 36 degrees	SURCHARGE TYPE:	U Uniform
DENSITY: 115 pcf	INITIAL FAILURE ANGLE:	20 degrees
SAFETY FACTOR: 1.25	FINAL FAILURE ANGLE:	70 degrees
WALL FRICTION: 0 degrees	INITIAL TENSION CRACK:	5 feet
CD (C/FS): 432.0 psf	FINAL TENSION CRACK:	100 feet
PHID = ATAN(TAN(PHI)/FS) =		30.2 degrees

CALCULATED RESULTS

CRITICAL FAILURE ANGLE	50 degrees
AREA OF TRIAL FAILURE WEDGE	47.6 square feet
TOTAL EXTERNAL SURCHARGE	0.0 pounds
WEIGHT OF TRIAL FAILURE WEDGE	5474.4 pounds
NUMBER OF TRIAL WEDGES ANALYZED	4896 trials
LENGTH OF FAILURE PLANE	7.8 feet
DEPTH OF TENSION CRACK	9.0 feet
HORIZONTAL DISTANCE TO UPSLOPE TENSION CRACK	5.0 feet
CALCULATED HORIZONTAL THRUST	-1114.0 pounds
CALCULATED EQUIVALENT FLUID PRESSURE	-22.3 pcf
MAXIMUM HEIGHT OF TEMPORARY EXCAVATION	10.0 feet

CONCLUSIONS:

THE CALCULATION INDICATES THAT THE TEMPORARY EXCAVATIONS UP TO 10 FEET HIGH IN BEDROCK WITH A 1:1 BACKSLOPE HAVE A NEGATIVE THRUST AND ARE TEMPORARILY STABLE.



**BYER
GEOTECHNICAL
INC.**

1461 East Chevy Chase Drive, Suite 200, Glendale, CA 91206
tel 818.549.9959 fax 818.543.3747

SHORING PILE

BG: **21898** CONSULTANT: **RIZ**
CLIENT: **HARVARD-WESTLAKE**

CALCULATION SHEET #

CALCULATE THE DESIGN MINIMUM EQUIVALENT FLUID PRESSURE (EFP) FOR TEMPORARY SHORING. THE WALL HEIGHT, BACKSLOPE AND SURCHARGE CONDITIONS ARE LISTED BELOW. ASSUME THE BACKFILL IS SATURATED WITH NO EXCESS HYDROSTATIC PRESSURE.

CALCULATION PARAMETERS

EARTH MATERIAL:	BEDROCK (SOUTH)	RETAINED LENGTH	20 feet
SHEAR DIAGRAM:	3	BACKSLOPE ANGLE:	34 degrees
COHESION:	540 psf	SURCHARGE:	0 pounds
PHI ANGLE:	36 degrees	SURCHARGE TYPE:	P Point
DENSITY	115 pcf	INITIAL FAILURE ANGLE:	30 degrees
SAFETY FACTOR:	1.25	FINAL FAILURE ANGLE:	70 degrees
PILE FRICTION	0 degrees	INITIAL TENSION CRACK:	1 feet
CD (C/FS):	432.0 psf	FINAL TENSION CRACK:	50 feet
PHID = ATAN(TAN(PHI)/FS) =	30.2 degrees		
HORIZONTAL PSEUDO STATIC SEISMIC COEFFICIENT (k _h)			0 g
VERTICAL PSEUDO STATIC SEISMIC COEFFICIENT (k _v)			0 g

CALCULATED RESULTS

CRITICAL FAILURE ANGLE	57 degrees
AREA OF TRIAL FAILURE WEDGE	132.3 square feet
TOTAL EXTERNAL SURCHARGE	0.0 pounds
WEIGHT OF TRIAL FAILURE WEDGE	15215.5 pounds
NUMBER OF TRIAL WEDGES ANALYZED	2050 trials
LENGTH OF FAILURE PLANE	14.7 feet
DEPTH OF TENSION CRACK	13.1 feet
HORIZONTAL DISTANCE TO UPSLOPE TENSION CRACK	8.0 feet
CALCULATED THRUST ON PILE	1548.9 pounds
CALCULATED EQUIVALENT FLUID PRESSURE	7.7 pcf
DESIGN EQUIVALENT FLUID PRESSURE	30.0 pcf

Conclusions:

THE CALCULATION INDICATES THAT THE PROPOSED SHORING PILES TO A HEIGHT OF 20 FEET MAY BE DESIGNED FOR AN EQUIVALENT FLUID PRESSURE OF 30 POUNDS PER CUBIC FOOT. THE FLUID PRESSURE SHOULD BE MULTIPLIED BY THE PILE SPACING.



**BYER
GEOTECHNICAL
INC.**

1461 East Chevy Chase Drive, Suite 200, Glendale, CA 91206
tel 818.549.9959 fax 818.543.3747

BEARING CAPACITY ANALYSIS

BG: **21898** CONSULTANT: **JWB**
CLIENT: **HARVARD-WESTLAKE**

CALCULATION SHEET #

CALCULATE THE ULTIMATE AND ALLOWABLE BEARING CAPACITY OF THE BEDROCK USING HANSEN'S METHOD. (REFERENCE: J. BOWLES, *FOUNDATION ANALYSIS AND DESIGN*, 1988, p. 188-194).

CALCULATION PARAMETERS

EARTH MATERIAL: BEDROCK (SOUTH)	EMBEDMENT DEPTH:	1 foot
SHEAR DIAGRAM: 4	FOOTING LENGTH:	100 feet
COHESION: 540 psf	FOOTING WIDTH:	2 feet
PHI ANGLE: 36 degrees	SLOPE ANGLE:	0 degrees
DENSITY: 115 pcf	FOOTING INCLINATION:	0 degrees
SAFETY FACTOR: 3		
FOOTING TYPE: s Strip		

CALCULATED RESULTS

HANSEN'S SHAPE, DEPTH, AND INCLINATION FACTORS

Nq = 37.75	Dq = 1.12	Sy = 0.99
Nc = 50.59	Gc = 1.00	Dy = 1.00
Ny = 40.05	Bc = 1.00	ly = 1.00
Sc = 1.01	lq = 1.00	Gy = 1.00
Sq = 1.01	lc = 1.00	Gq = 1.00
Dc = 1.20	Bq = 1.00	By = 1.00

CALCULATED ULTIMATE BEARING CAPACITY (Qult)	42,786.3 pounds
ALLOWABLE BEARING CAPACITY (Qa = Qult / fs)	14,262.1 pounds
	27.1%

CONCLUSIONS:

THE ULTIMATE AND ALLOWABLE BEARING CAPACITIES OF THE BEDROCK WERE CALCULATED USING HANSEN'S METHOD. THE DESIGN BEARING PRESSURE FOR THE PURPOSE OF CHECKING THE SOIL NAIL BLOCK AS A CONVENTIONAL RETAINING WALL IS 14,000 POUNDS PER SQUARE FOOT FOR THE SOUTH BEDROCK (SECTIONS 3 AND 5).



**BYER
GEOTECHNICAL
INC.**

1461 East Chevy Chase Drive, Suite 200, Glendale, CA 91206
tel 818.549.9959 fax 818.543.3747

BEARING CAPACITY ANALYSIS

BG: 21898 CONSULTANT: JWB
CLIENT: HARVARD-WESTLAKE

CALCULATION SHEET #

CALCULATE THE ULTIMATE AND ALLOWABLE BEARING CAPACITY OF THE BEDROCK USING HANSEN'S METHOD. (REFERENCE: J. BOWLES, *FOUNDATION ANALYSIS AND DESIGN*, 1988, p. 188-194).

CALCULATION PARAMETERS

EARTH MATERIAL:	BEDROCK (NORTH)	EMBEDMENT DEPTH:	1 foot
SHEAR DIAGRAM:	2	FOOTING LENGTH:	100 feet
COHESION:	1044 psf	FOOTING WIDTH:	3 feet
PHI ANGLE:	36.5 degrees	SLOPE ANGLE:	0 degrees
DENSITY:	100 pcf	FOOTING INCLINATION:	0 degrees
SAFETY FACTOR:	3		
FOOTING TYPE:	s Strip		

CALCULATED RESULTS

HANSEN'S SHAPE, DEPTH, AND INCLINATION FACTORS

Nq =	40.24	Dq =	1.08	Sy =	0.99
Nc =	53.03	Gc =	1.00	Dy =	1.00
Ny =	43.55	Bc =	1.00	ly =	1.00
Sc =	1.02	lq =	1.00	Gy =	1.00
Sq =	1.02	lc =	1.00	Gq =	1.00
Dc =	1.13	Bq =	1.00	By =	1.00

CALCULATED ULTIMATE BEARING CAPACITY (Qult)	75,073.5 pounds
ALLOWABLE BEARING CAPACITY (Qa = Qult / fs)	25,024.5 pounds
	16.9%

CONCLUSIONS:

THE ULTIMATE AND ALLOWABLE BEARING CAPACITIES OF THE BEDROCK WERE CALCULATED USING HANSEN'S METHOD. THE DESIGN BEARING PRESSURE FOR THE PURPOSE OF CHECKING THE SOIL NAIL BLOCK AS A CONVENTIONAL RETAINING WALL IS 25,000 POUNDS PER SQUARE FOOT FOR THE NORTH BEDROCK (SECTIONS 1 AND 6).

BG 21898 HARVARD WESTLAKE SECTION 1
 DETERMINE ALL PLANES THROUGH THE BASE OF THE PROPOSED SOIL NAIL WALLS WITH A FACTOR OF SAFETY OF 1.5 OR LESS.

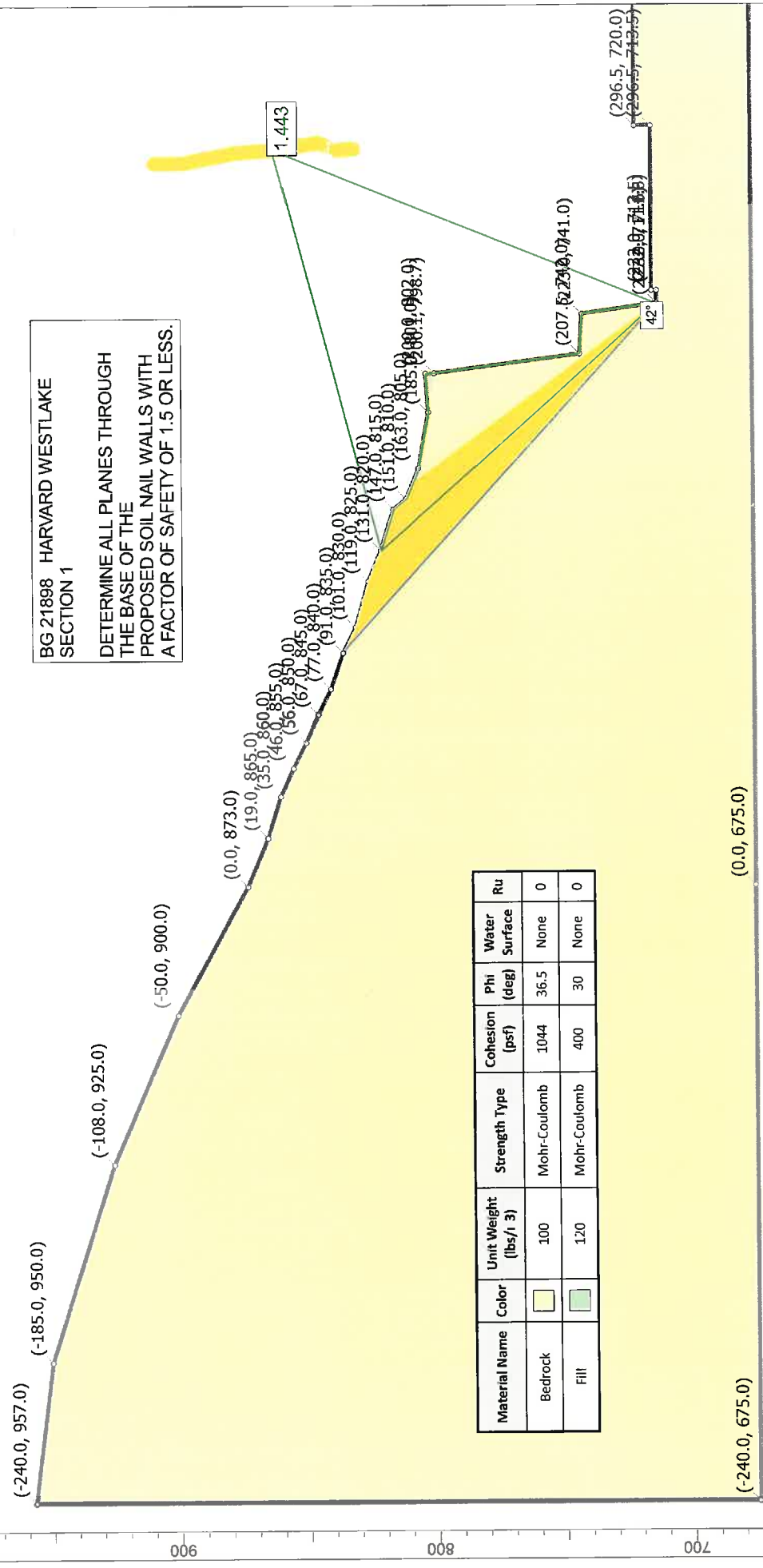



SLIDEINTERPRET 6.033

Project BG 21898 HARVARD-WESTLAKE SECTION 1

Analysis Description SHOW ALL PLANES WITH <= 1.5 FROM BASE OF THE SOIL NAIL WALLS

Drawn By R. ZWEIGLER **Scale** 1:692 **Company** BYER GEOTECHNICAL, INC.

Date 2/12/15 **File Name** 21898 Section 1 planar.slim

Slide Analysis Information

BG 21898 HARVARD-WESTLAKE SECTION 1

Project Summary

File Name: 21898 Section 1 planar
Slide Modeler Version: 6.033
Project Title: BG 21898 HARVARD-WESTLAKE SECTION 1
Analysis: SHOW ALL PLANES WITH ≤ 1.5 FROM BASE OF THE SOIL NAIL WALLS
Author: R. ZWEIGLER
Company: BYER GEOTECHNICAL, INC.
Date Created: 2/12/15

General Settings

Units of Measurement: Imperial Units
Time Units: days
Permeability Units: feet/second
Failure Direction: Left to Right
Data Output: Standard
Maximum Material Properties: 20
Maximum Support Properties: 20

Analysis Options

Analysis Methods Used

Bishop simplified

Number of slices: 25
Tolerance: 0.005
Maximum number of iterations: 50
Check $\alpha < 0.2$: Yes
Initial trial value of FS: 1
Steffensen Iteration: Yes

Groundwater Analysis

Groundwater Method: Water Surfaces
Pore Fluid Unit Weight: 62.4 lbs/ft³
Advanced Groundwater Method: None

 BYER GEOTECHNICAL INC.	<i>Project</i> BG 21898 HARVARD-WESTLAKE SECTION 1		
	<i>Analysis Description</i> SHOW ALL PLANES WITH ≤ 1.5 FROM BASE OF THE SOIL NAIL WALLS		
	<i>Drawn By</i> R. ZWEIGLER	<i>Scale</i>	<i>Company</i> BYER GEOTECHNICAL, INC.
	<i>Date</i> 2/12/15	<i>File Name</i> 21898 Section 1 planar.slim	

Random Numbers

Pseudo-random Seed: 10116

Random Number Generation Method: Park and Miller v.3

Surface Options

Surface Type: Non-Circular Block Search

Number of Surfaces: 5000

Pseudo-Random Surfaces: Enabled

Convex Surfaces Only: Enabled

Left Projection Angle (Start Angle): 95

Left Projection Angle (End Angle): 220



Right Projection Angle (Start Angle): -85

Right Projection Angle (End Angle): 85

Minimum Elevation: Not Defined

Minimum Depth: Not Defined

Material Properties

Property	Bedrock	Fill
Color		
Strength Type	Mohr-Coulomb	Mohr-Coulomb
Unit Weight [lbs/ft3]	100	120
Cohesion [psf]	1044	400
Friction Angle [deg]	36.5	30
Water Surface	None	None
Ru Value	0	0

Global Minimums

Method: bishop simplified

FS: 1.443240

Axis Location: 287.440, 861.869

Left Slip Surface Endpoint: 130.976, 820.010

Right Slip Surface Endpoint: 227.049, 711.582

Resisting Moment=3.82141e+007 lb-ft

Driving Moment=2.6478e+007 lb-ft

Total Slice Area=2371.63 ft²

Global Minimum Coordinates

 BYER GEOTECHNICAL INC.	<i>Project</i> BG 21898 HARVARD-WESTLAKE SECTION 1		
	<i>Analysis Description</i> SHOW ALL PLANES WITH ≤ 1.5 FROM BASE OF THE SOIL NAIL WALLS		
	<i>Drawn By</i> R. ZWEIGLER	<i>Scale</i>	<i>Company</i> BYER GEOTECHNICAL, INC.
	<i>Date</i> 2/12/15	<i>File Name</i> 21898 Section 1 planar.slim	

Method: bishop simplified

X	Y
130.976	820.01
227.049	711.582

Valid / Invalid Surfaces

Method: bishop simplified

Number of Valid Surfaces: 3586

Number of Invalid Surfaces: 1415

Error Codes:

Error Code -105 reported for 535 surfaces

Error Code -108 reported for 14 surfaces

Error Code -112 reported for 167 surfaces

Error Code -1000 reported for 699 surfaces

Error Codes

The following errors were encountered during the computation:

-105 = More than two surface / slope intersections with no valid slip surface.

-108 = Total driving moment or total driving force < 0.1. This is to limit the calculation of extremely high safety factors if the driving force is very small (0.1 is an arbitrary number).

-112 = The coefficient $M\text{-Alpha} = \cos(\alpha)(1 + \tan(\alpha)\tan(\phi))/F < 0.2$ for the final iteration of the safety factor calculation. This screens out some slip surfaces which may not be valid in the context of the analysis, in particular, deep seated slip surfaces with many high negative base angle slices in the passive zone.

-1000 = No valid slip surfaces are generated at a grid center. Unable to draw a surface.

Slice Data

Global Minimum Query (bishop simplified) - Safety Factor: 1.44324

Slice Number	Width [ft]	Weight [lbs]	Base Material	Base Cohesion [psf]	Base Friction Angle [degrees]	Shear Stress [psf]	Shear Strength [psf]	Base Normal Stress [psf]	Pore Pressure [psf]	Effective Normal Stress [psf]
1	3.84293	601.64	Bedrock	1044	36.5	509.078	734.722	-417.965	0	-417.965
2	3.84293	1806.86	Bedrock	1044	36.5	610.937	881.728	-219.298	0	-219.298
3	3.84293	3012.09	Bedrock	1044	36.5	712.795	1028.73	-20.6305	0	-20.6305
4	3.84293	4217.31	Bedrock	1044	36.5	814.654	1175.74	178.038	0	178.038
5	3.84293	4945.44	Bedrock	1044	36.5	876.19	1264.55	298.061	0	298.061
6	3.84293	5169.47	Bedrock	1044	36.5	895.125	1291.88	334.991	0	334.991

 BYER GEOTECHNICAL INC.	Project		BG 21898 HARVARD-WESTLAKE SECTION 1					
	Analysis Description				SHOW ALL PLANES WITH <= 1.5 FROM BASE OF THE SOIL NAIL WALLS			
	Drawn By		R. ZWEIGLER	Scale	Company		BYER GEOTECHNICAL, INC.	
	Date		2/12/15		File Name		21898 Section 1 planar.slim	

7	3.84293	6193.54	Bedrock	1044	36.5	981.673	1416.79	503.798	0	503.798
8	3.84293	7244.93	Bedrock	1044	36.5	1070.53	1545.03	677.108	0	677.108
9	3.84293	8373.4	Bedrock	1044	36.5	1165.9	1682.68	863.122	0	863.122
10	3.84293	9752.35	Bedrock	1044	36.5	1282.44	1850.87	1090.43	0	1090.43
11	3.84293	11150.6	Bedrock	1044	36.5	1400.61	2021.42	1320.91	0	1320.91
12	3.84293	12548.8	Bedrock	1044	36.5	1518.78	2191.97	1551.39	0	1551.39
13	3.84293	13947	Bedrock	1044	36.5	1636.95	2362.51	1781.86	0	1781.86
14	3.84293	15345.2	Bedrock	1044	36.5	1755.12	2533.06	2012.35	0	2012.35
15	3.84293	16934.9	Bedrock	1044	36.5	1889.46	2726.95	2274.38	0	2274.38
16	3.84293	18763.9	Bedrock	1044	36.5	2044.05	2950.05	2575.88	0	2575.88
17	3.84293	20593.6	Bedrock	1044	36.5	2198.68	3173.23	2877.48	0	2877.48
18	3.84293	22391.6	Bedrock	1044	36.5	2350.64	3392.54	3173.87	0	3173.87
19	3.84293	16926.3	Bedrock	1044	36.5	1888.74	2725.91	2272.96	0	2272.96
20	3.84293	7262.32	Bedrock	1044	36.5	1072	1547.15	679.974	0	679.974
21	3.84293	4133.23	Bedrock	1044	36.5	807.548	1165.48	164.177	0	164.177
22	3.84293	5704.68	Bedrock	1044	36.5	940.357	1357.16	423.213	0	423.213
23	3.84293	7276.13	Bedrock	1044	36.5	1073.17	1548.84	682.25	0	682.25
24	3.84293	8832.29	Bedrock	1044	36.5	1204.69	1738.65	938.765	0	938.765
25	3.84293	4531.53	Bedrock	1044	36.5	841.21	1214.07	229.833	0	229.833

Interslice Data

Global Minimum Query (bishop simplified) - Safety Factor: 1.44324

Slice Number	X coordinate [ft]	Y coordinate - Bottom [ft]	Interslice Normal Force [lbs]	Interslice Shear Force [lbs]	Interslice Force Angle [degrees]
1	130.976	820.01	0	0	0
2	134.819	815.673	-3769.05	0	0
3	138.662	811.336	-7067.88	0	0
4	142.504	806.999	-9896.48	0	0
5	146.347	802.662	-12254.9	0	0
6	150.19	798.325	-14329.1	0	0
7	154.033	793.987	-16316	0	0
8	157.876	789.65	-17903.4	0	0
9	161.719	785.313	-19080.5	0	0
10	165.562	780.976	-19817.3	0	0
11	169.405	776.639	-20016.2	0	0
12	173.248	772.302	-19669.5	0	0
13	177.091	767.965	-18777.3	0	0
14	180.934	763.628	-17339.6	0	0
15	184.777	759.29	-15356.3	0	0
16	188.62	754.953	-12752.9	0	0

	Project		BG 21898 HARVARD-WESTLAKE SECTION 1	
	Analysis Description		SHOW ALL PLANES WITH <= 1.5 FROM BASE OF THE SOIL NAIL WALLS	
	Drawn By	R. ZWEIGLER	Scale	Company
	Date	2/12/15	File Name	BYER GEOTECHNICAL, INC. 21898 Section 1 planar.slim

17	192.463	750.616	-9435.83	0	0
18	196.306	746.279	-5404.9	0	0
19	200.148	741.942	-672.456	0	0
20	203.991	737.605	1927.65	0	0
21	207.834	733.268	757.301	0	0
22	211.677	728.931	-1633.88	0	0
23	215.52	724.593	-3411.95	0	0
24	219.363	720.256	-4576.91	0	0
25	223.206	715.919	-5134.72	0	0
26	227.049	711.582	0	0	0

List Of Coordinates

External Boundary

X	Y
223	741
207.5	742
200.137	798.701
200	802
185	801
163	805
151	810
147	815
131	820
119	825
101	830
91	835
77	840
67	845
56	850
46	855
35	860
19	865
0	873
-50	900
-108	925
-185	950
-240	957
-240	675
0	675
500	675

 <p>BYER GEOTECHNICAL INC.</p>	<i>Project</i> BG 21898 HARVARD-WESTLAKE SECTION 1			
	<i>Analysis Description</i> SHOW ALL PLANES WITH <= 1.5 FROM BASE OF THE SOIL NAIL WALLS			
	<i>Drawn By</i> R. ZWEIGLER	<i>Scale</i>	<i>Company</i> BYER GEOTECHNICAL, INC.	
	<i>Date</i> 2/12/15		<i>File Name</i> 21898 Section 1 planar.slim	

500	712.5
467	712.5
426	720
296.5	720
296.5	713.5
232	713.5
232	711.582
227.049	711.582

Material Boundary

X	Y
185	801
200.137	798.701



**BYER
GEOTECHNICAL
INC.**

<i>Project</i>	BG 21898 HARVARD-WESTLAKE SECTION 1		
<i>Analysis Description</i>	SHOW ALL PLANES WITH ≤ 1.5 FROM BASE OF THE SOIL NAIL WALLS		
<i>Drawn By</i>	R. ZWEIGLER	<i>Scale</i>	<i>Company</i> BYER GEOTECHNICAL, INC.
<i>Date</i>	2/12/15	<i>File Name</i>	21898 Section 1 planar.slim

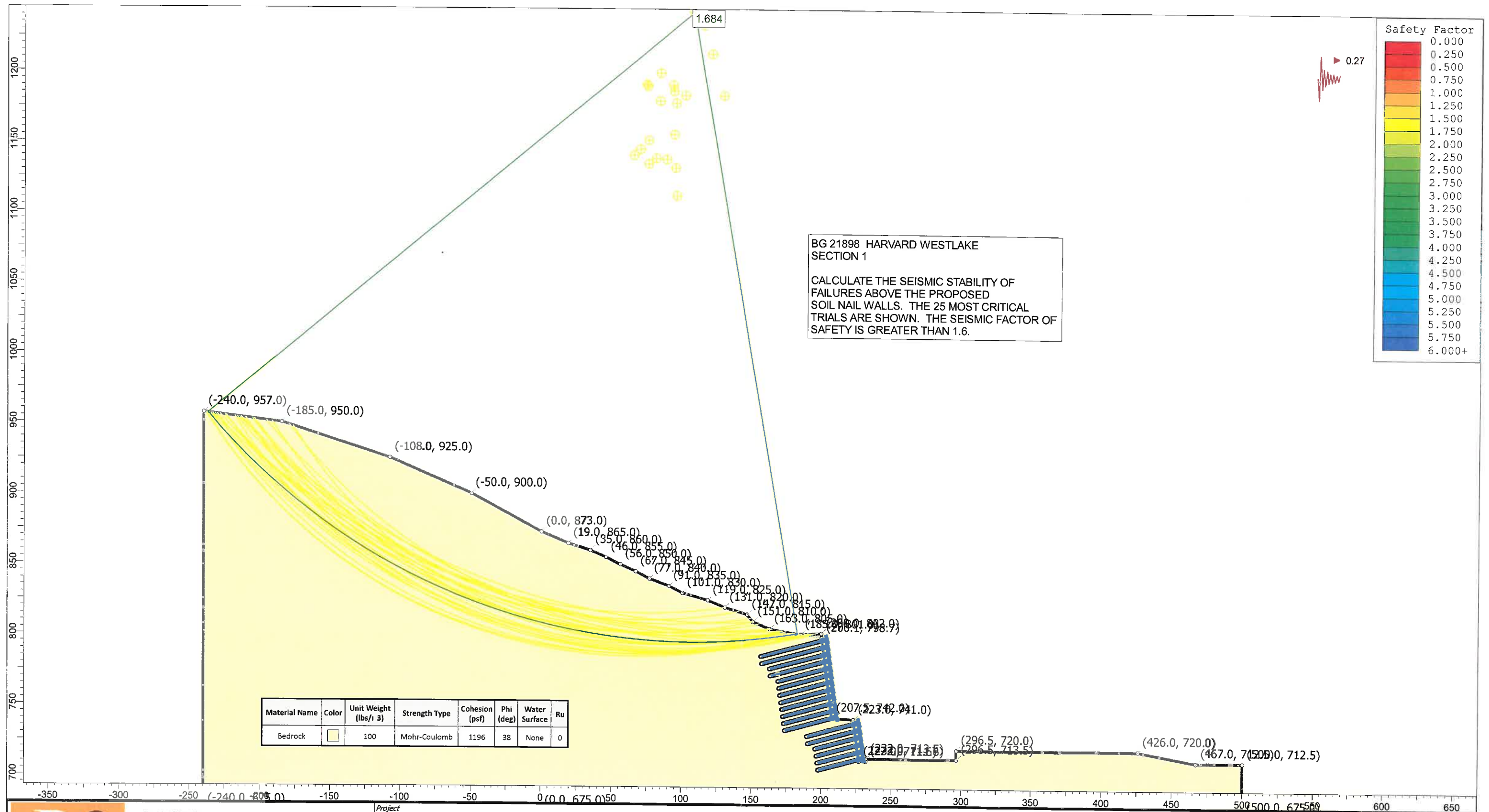

	Project			BG 21898 HARVARD-WESTLAKE SECTION 1		
	Analysis Description			CALCULATE THE SEISMIC STABILITY ABOVE THE SOIL NAIL WALLS		
	Drawn By		R. ZWEIGLER	Scale		1:762
	Date		2/12/15	Company		BYER GEOTECHNICAL, INC.
			File Name		21898 Section 1 above soil nails EQ.slim	

Slide Analysis Information

BG 21898 HARVARD-WESTLAKE SECTION 1

Project Summary

File Name: 21898 Section 1 above soil nails EQ
Slide Modeler Version: 6.033
Project Title: BG 21898 HARVARD-WESTLAKE SECTION 1
Analysis: CALCULATE THE SEISMIC STABILITY ABOVE THE SOIL NAIL WALLS
Author: R. ZWEIGLER
Company: BYER GEOTECHNICAL, INC.
Date Created: 2/12/15

General Settings

Units of Measurement: Imperial Units
Time Units: days
Permeability Units: feet/second
Failure Direction: Left to Right
Data Output: Standard
Maximum Material Properties: 20
Maximum Support Properties: 20

Analysis Options

Analysis Methods Used

Bishop simplified

Number of slices: 25
Tolerance: 0.005
Maximum number of iterations: 50
Check malpha < 0.2: Yes
Initial trial value of FS: 1
Steffensen Iteration: Yes

Groundwater Analysis

Groundwater Method: Water Surfaces
Pore Fluid Unit Weight: 62.4 lbs/ft³
Advanced Groundwater Method: None

 BYER GEOTECHNICAL INC.	<i>Project</i> BG 21898 HARVARD-WESTLAKE SECTION 1		
	<i>Analysis Description</i> CALCULATE THE SEISMIC STABILITY ABOVE THE SOIL NAIL WALLS		
	<i>Drawn By</i> R. ZWEIGLER	<i>Scale</i>	<i>Company</i> BYER GEOTECHNICAL, INC.
	<i>Date</i> 2/12/15	<i>File Name</i> 21898 Section 1 above soil nails EQ.slim	

Random Numbers

Pseudo-random Seed: 10116

Random Number Generation Method: Park and Miller v.3

Surface Options

Surface Type: Circular

Search Method: Slope Search

Number of Surfaces: 5000

Upper Angle: Not Defined

Lower Angle: Not Defined

Composite Surfaces: Disabled

Reverse Curvature: Create Tension Crack

Minimum Elevation: Not Defined

Minimum Depth: Not Defined

Loading

Seismic Load Coefficient (Horizontal): 0.27

Material Properties

Property	Bedrock	Fill
Color	<input type="checkbox"/>	<input type="checkbox"/>
Strength Type	Mohr-Coulomb	Mohr-Coulomb
Unit Weight [lbs/ft ³]	100	120
Cohesion [psf]	1196	400
Friction Angle [deg]	38	30
Water Surface	None	None
Ru Value	0	0

Support Properties

Soil Nail

Support Type: Soil Nail

Force Application: Passive

Out-of-Plane Spacing: 5 ft

Tensile Capacity: 33333 lb

Plate Capacity: 37100 lb

 BYER GEOTECHNICAL INC.	<i>Project</i> BG 21898 HARVARD-WESTLAKE SECTION 1		
	<i>Analysis Description</i> CALCULATE THE SEISMIC STABILITY ABOVE THE SOIL NAIL WALLS		
	<i>Drawn By</i> R. ZWEIGLER	<i>Scale</i>	<i>Company</i> BYER GEOTECHNICAL, INC.
	<i>Date</i> 2/12/15	<i>File Name</i> 21898 Section 1 above soil nails EQ.slim	

Default Bond Strength: 2413 lb/ft
and Material Dependent

Bond Strength Dependency:

Material	Bond Strength (lbs/ft)
Bedrock	2413

Global Minimums

Method: bishop simplified

FS: 1.683860
Center: 107.534, 1242.991
Radius: 447.862
Left Slip Surface Endpoint: -236.784, 956.591
Right Slip Surface Endpoint: 182.519, 801.451
Resisting Moment=8.9484e+008 lb-ft
Driving Moment=5.31422e+008 lb-ft
Total Slice Area=20793.1 ft²

Valid / Invalid Surfaces

Method: bishop simplified

Number of Valid Surfaces: 4948
Number of Invalid Surfaces: 52

Error Codes:

Error Code -101 reported for 1 surface
Error Code -106 reported for 47 surfaces
Error Code -112 reported for 4 surfaces

Error Codes

The following errors were encountered during the computation:

- 101 = Only one (or zero) surface / slope intersections.
- 106 = Average slice width is less than 0.0001 * (maximum horizontal extent of soil region). This limitation is imposed to avoid numerical errors which may result from too many slices, or too small a slip region.
- 112 = The coefficient $M-\alpha = \cos(\alpha)(1 + \tan(\alpha)\tan(\phi)/F) < 0.2$ for the final iteration of the safety factor calculation. This screens out some slip surfaces which may not be valid in the context of the analysis, in particular, deep seated slip surfaces with many high negative base angle slices in the passive zone.

 BYER GEOTECHNICAL INC.	Project BG 21898 HARVARD-WESTLAKE SECTION 1		
	Analysis Description CALCULATE THE SEISMIC STABILITY ABOVE THE SOIL NAIL WALLS		
	Drawn By R. ZWEIGLER	Scale	Company BYER GEOTECHNICAL, INC.
	Date 2/12/15	File Name 21898 Section 1 above soil nails EQ.slim	

Slice Data

Global Minimum Query (bishop simplified) - Safety Factor: 1.68386

Slice Number	Width [ft]	Weight [lbs]	Base Material	Base Cohesion [psf]	Base Friction Angle [degrees]	Shear Stress [psf]	Shear Strength [psf]	Base Normal Stress [psf]	Pore Pressure [psf]	Effective Normal Stress [psf]
1	16.7721	14176.8	Bedrock	1196	38	722.339	1216.32	26.006	0	26.006
2	16.7721	40861.4	Bedrock	1196	38	1251.11	2106.69	1165.63	0	1165.63
3	16.7721	64460.7	Bedrock	1196	38	1750.39	2947.41	2241.7	0	2241.7
4	16.7721	83101.3	Bedrock	1196	38	2174.28	3661.19	3155.3	0	3155.3
5	16.7721	96201.5	Bedrock	1196	38	2501.05	4211.41	3859.55	0	3859.55
6	16.7721	107210	Bedrock	1196	38	2793.92	4704.57	4490.76	0	4490.76
7	16.7721	116346	Bedrock	1196	38	3054.33	5143.06	5052.01	0	5052.01
8	16.7721	123610	Bedrock	1196	38	3279.72	5522.59	5537.76	0	5537.76
9	16.7721	127138	Bedrock	1196	38	3425.87	5768.68	5852.77	0	5852.77
10	16.7721	128492	Bedrock	1196	38	3523.85	5933.67	6063.94	0	6063.94
11	16.7721	128449	Bedrock	1196	38	3589.25	6043.8	6204.89	0	6204.89
12	16.7721	125937	Bedrock	1196	38	3595.26	6053.92	6217.87	0	6217.87
13	16.7721	120266	Bedrock	1196	38	3522.4	5931.23	6060.8	0	6060.8
14	16.7721	113349	Bedrock	1196	38	3414.05	5748.79	5827.32	0	5827.32
15	16.7721	106561	Bedrock	1196	38	3303.2	5562.13	5588.39	0	5588.39
16	16.7721	101509	Bedrock	1196	38	3231.13	5440.77	5433.06	0	5433.06
17	16.7721	96190.8	Bedrock	1196	38	3148.48	5301.6	5254.93	0	5254.93
18	16.7721	86624.7	Bedrock	1196	38	2950.47	4968.18	4828.17	0	4828.17
19	16.7721	76050.2	Bedrock	1196	38	2718.09	4576.88	4327.32	0	4327.32
20	16.7721	66198.5	Bedrock	1196	38	2496.94	4204.49	3850.69	0	3850.69
21	16.7721	55598.3	Bedrock	1196	38	2247.21	3783.99	3312.47	0	3312.47
22	16.7721	46024.1	Bedrock	1196	38	2017.52	3397.22	2817.43	0	2817.43
23	16.7721	34323.7	Bedrock	1196	38	1718.78	2894.19	2173.58	0	2173.58
24	16.7721	15958.5	Bedrock	1196	38	1214.8	2045.56	1087.38	0	1087.38
25	16.7721	4672.74	Bedrock	1196	38	902.46	1519.62	414.209	0	414.209

Interslice Data

Global Minimum Query (bishop simplified) - Safety Factor: 1.68386

Slice Number	X coordinate [ft]	Y coordinate - Bottom [ft]	Interslice Normal Force [lbs]	Interslice Shear Force [lbs]	Interslice Force Angle [degrees]
1	-236.784	956.591	0	0	0
2	-220.012	937.551	-7781.16	0	0
3	-203.24	920.501	2160.47	0	0
4	-186.468	905.14	24668.4	0	0

	Project		BG 21898 HARVARD-WESTLAKE SECTION 1	
	Analysis Description		CALCULATE THE SEISMIC STABILITY ABOVE THE SOIL NAIL WALLS	
	Drawn By	R. ZWEIGLER	Scale	Company
	Date	2/12/15	File Name	21898 Section 1 above soil nails EQ.slim
BYER GEOTECHNICAL INC.		BYER GEOTECHNICAL, INC.		

5	-169.695	891.247	54509.3	0	0
6	-152.923	878.653	87180.5	0	0
7	-136.151	867.228	120617	0	0
8	-119.379	856.869	153187	0	0
9	-102.607	847.49	183540	0	0
10	-85.8349	839.025	210006	0	0
11	-69.0628	831.417	231788	0	0
12	-52.2907	824.618	248510	0	0
13	-35.5186	818.59	259747	0	0
14	-18.7465	813.301	265251	0	0
15	-1.9744	808.724	265320	0	0
16	14.7977	804.836	260469	0	0
17	31.5698	801.619	251212	0	0
18	48.3419	799.058	237880	0	0
19	65.114	797.143	221077	0	0
20	81.8861	795.864	201596	0	0
21	98.6582	795.217	180121	0	0
22	115.43	795.199	157537	0	0
23	132.202	795.809	134437	0	0
24	148.975	797.051	112205	0	0
25	165.747	798.929	94115.8	0	0
26	182.519	801.451	0	0	0

List Of Coordinates

External Boundary

X	Y
223	741
207.5	742
200.137	798.701
200	802
185	801
163	805
151	810
147	815
131	820
119	825
101	830
91	835
77	840
67	845

 <p>BYER GEOTECHNICAL INC.</p>	<i>Project</i> BG 21898 HARVARD-WESTLAKE SECTION 1		
	<i>Analysis Description</i> CALCULATE THE SEISMIC STABILITY ABOVE THE SOIL NAIL WALLS		
	<i>Drawn By</i> R. ZWEIGLER	<i>Scale</i>	<i>Company</i> BYER GEOTECHNICAL, INC.
	<i>Date</i> 2/12/15		<i>File Name</i> 21898 Section 1 above soil nails EQ.slim

56	850
46	855
35	860
19	865
0	873
-50	900
-108	925
-185	950
-240	957
-240	675
0	675
500	675
500	712.5
467	712.5
426	720
296.5	720
296.5	713.5
232	713.5
232	711.582
227.049	711.582

Material Boundary

X	Y
185	801
200.137	798.701

 <p>BYER GEOTECHNICAL INC.</p>	<i>Project</i> BG 21898 HARVARD-WESTLAKE SECTION 1		
	<i>Analysis Description</i> CALCULATE THE SEISMIC STABILITY ABOVE THE SOIL NAIL WALLS		
	<i>Drawn By</i> R. ZWEIGLER	<i>Scale</i>	<i>Company</i> BYER GEOTECHNICAL, INC.
	<i>Date</i> 2/12/15		<i>File Name</i> 21898 Section 1 above soil nails EQ.slim

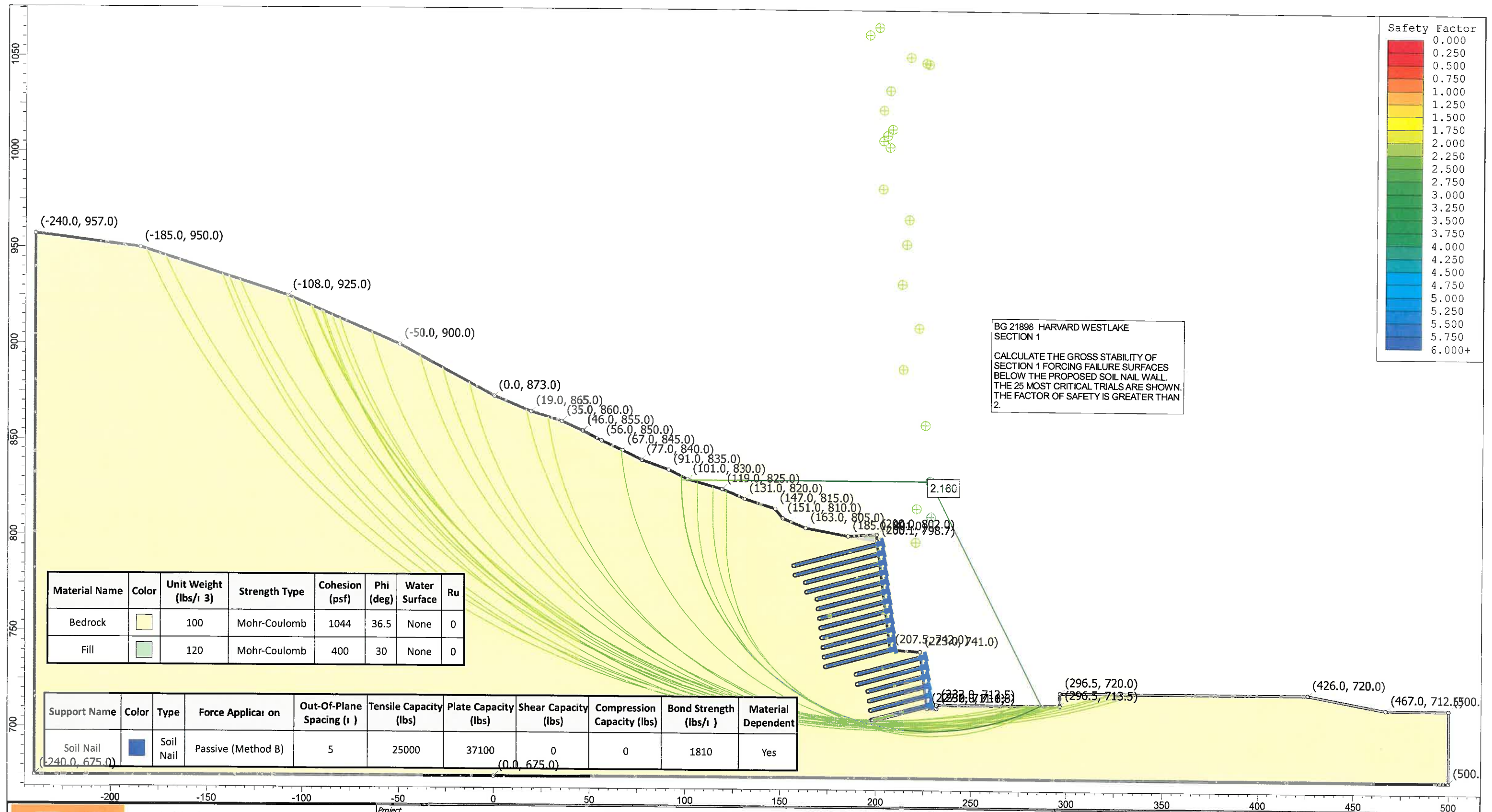

BG 21898 HARVARD WESTLAKE SECTION 1
 CALCULATE THE GROSS STABILITY OF SECTION 1 FORCING FAILURE SURFACES BELOW THE PROPOSED SOIL NAIL WALL. THE 25 MOST CRITICAL TRIALS ARE SHOWN. THE FACTOR OF SAFETY IS GREATER THAN 2.

Material Name	Color	Unit Weight (lbs/ft ³)	Strength Type	Cohesion (psf)	Phi (deg)	Water Surface	Ru
Bedrock		100	Mohr-Coulomb	1044	36.5	None	0
Fill		120	Mohr-Coulomb	400	30	None	0

Support Name	Color	Type	Force Application	Out-Of-Plane Spacing (ft)	Tensile Capacity (lbs)	Plate Capacity (lbs)	Shear Capacity (lbs)	Compression Capacity (lbs)	Bond Strength (lbs/ft)	Material Dependent
Soil Nail		Soil Nail	Passive (Method B)	5	25000	37100	0	0	1810	Yes



Project	BG 21898 HARVARD-WESTLAKE SECTION 1		
Analysis Description	CALCULATE THE GROSS STABILITY BELOW THE SOIL NAIL WALLS		
Drawn By	R. ZWEIGLER	Scale	1:561
Date	2/12/15	Company	BYER GEOTECHNICAL, INC.
		File Name	21898 Section 1 ver 6 through soil nails.slim

Slide Analysis Information

BG 21898 HARVARD-WESTLAKE SECTION 1

Project Summary

File Name: 21898 Section 1 ver 6 through soil nails
Slide Modeler Version: 6.033
Project Title: BG 21898 HARVARD-WESTLAKE SECTION 1
Analysis: CALCULATE THE GROSS STABILITY BELOW THE SOIL NAIL WALLS
Author: R. ZWEIGLER
Company: BYER GEOTECHNICAL, INC.
Date Created: 2/12/15

General Settings

Units of Measurement: Imperial Units
Time Units: days
Permeability Units: feet/second
Failure Direction: Left to Right
Data Output: Standard
Maximum Material Properties: 20
Maximum Support Properties: 20

Analysis Options

Analysis Methods Used

Bishop simplified

Number of slices: 25
Tolerance: 0.005
Maximum number of iterations: 50
Check $m\alpha < 0.2$: Yes
Initial trial value of FS: 1
Steffensen Iteration: Yes

Groundwater Analysis

Groundwater Method: Water Surfaces
Pore Fluid Unit Weight: 62.4 lbs/ft³
Advanced Groundwater Method: None

 BYER GEOTECHNICAL INC.	<i>Project</i> BG 21898 HARVARD-WESTLAKE SECTION 1		
	<i>Analysis Description</i> CALCULATE THE GROSS STABILITY BELOW THE SOIL NAIL WALLS		
	<i>Drawn By</i> R. ZWEIGLER	<i>Scale</i>	<i>Company</i> BYER GEOTECHNICAL, INC.
	<i>Date</i> 2/12/15	<i>File Name</i> 21898 Section 1 ver 6 through soil nails.slim	

Random Numbers

Pseudo-random Seed: 10116

Random Number Generation Method: Park and Miller v.3

Surface Options

Surface Type: Circular

Search Method: Slope Search

Number of Surfaces: 5000

Upper Angle: Not Defined

Lower Angle: Not Defined

Composite Surfaces: Disabled

Reverse Curvature: Create Tension Crack

Minimum Elevation: Not Defined

Minimum Depth: Not Defined

Material Properties

Property	Bedrock	Fill
Color	<input type="checkbox"/>	<input type="checkbox"/>
Strength Type	Mohr-Coulomb	Mohr-Coulomb
Unit Weight [lbs/ft ³]	100	120
Cohesion [psf]	1044	400
Friction Angle [deg]	36.5	30
Water Surface	None	None
Ru Value	0	0

Support Properties

Soil Nail

Support Type: Soil Nail

Force Application: Passive

Out-of-Plane Spacing: 5 ft

Tensile Capacity: 25000 lb

Plate Capacity: 37100 lb

Default Bond Strength: 1810 lb/ft
and Material Dependent

Bond Strength Dependency:

 BYER GEOTECHNICAL INC.	<i>Project</i> BG 21898 HARVARD-WESTLAKE SECTION 1		
	<i>Analysis Description</i> CALCULATE THE GROSS STABILITY BELOW THE SOIL NAIL WALLS		
	<i>Drawn By</i> R. ZWEIGLER	<i>Scale</i>	<i>Company</i> BYER GEOTECHNICAL, INC.
	<i>Date</i> 2/12/15	<i>File Name</i> 21898 Section 1 ver 6 through soil nails.slim	

Material Bond Strength (lbs/ft)



Bedrock

1810

Global Minimums

Method: bishop simplified

FS: 2.160270
 Center: 227.884, 829.628
 Radius: 130.209
 Left Slip Surface Endpoint: 97.675, 829.628
 Right Slip Surface Endpoint: 286.779, 713.500
 Left Slope Intercept: 97.675 831.663
 Right Slope Intercept: 286.779 713.500
 Resisting Moment=1.26648e+008 lb-ft
 Driving Moment=5.8626e+007 lb-ft
 Total Slice Area=9816.06 ft2

Valid / Invalid Surfaces

Method: bishop simplified

Number of Valid Surfaces: 2442
 Number of Invalid Surfaces: 2558

Error Codes:

Error Code -100 reported for 15 surfaces
 Error Code -101 reported for 1 surface
 Error Code -103 reported for 2445 surfaces
 Error Code -109 reported for 22 surfaces
 Error Code -112 reported for 75 surfaces

Error Codes

The following errors were encountered during the computation:

- 100 = Both surface / slope intersections are on the same horizontal surface. In general, this will give a very high or infinite factor of safety (zero driving force), if calculated.
- 101 = Only one (or zero) surface / slope intersections.
- 103 = Two surface / slope intersections, but one or more surface / nonslope external polygon intersections lie between them. This usually occurs when the slip surface extends past the bottom of the soil region, but may also occur on a benched slope model with two sets of Slope Limits.
- 109 = Soiltype for slice base not located. This error should occur very rarely, if at all. It may occur if a very low number of slices is combined with certain soil geometries, such that the midpoint of a slice base is actually outside the soil region, even though the slip surface is wholly within the soil region.

 <p>BYER GEOTECHNICAL INC.</p>	Project			BG 21898 HARVARD-WESTLAKE SECTION 1	
	Analysis Description			CALCULATE THE GROSS STABILITY BELOW THE SOIL NAIL WALLS	
	Drawn By	R. ZWEIGLER	Scale	Company	BYER GEOTECHNICAL, INC.
	Date	2/12/15		File Name	21898 Section 1 ver 6 through soil nails.slim

-112 = The coefficient $M\text{-Alpha} = \cos(\alpha)(1+\tan(\alpha)\tan(\phi)/F) < 0.2$ for the final iteration of the safety factor calculation. This screens out some slip surfaces which may not be valid in the context of the analysis, in particular, deep seated slip surfaces with many high negative base angle slices in the passive zone.

Slice Data

Global Minimum Query (bishop simplified) - Safety Factor: 2.16027

Slice Number	Width [ft]	Weight [lbs]	Base Material	Base Cohesion [psf]	Base Friction Angle [degrees]	Shear Stress [psf]	Shear Strength [psf]	Base Normal Stress [psf]	Pore Pressure [psf]	Effective Normal Stress [psf]
1	7.56418	16848.9	Bedrock	1044	36.5	418.15	903.316	-190.124	0	-190.124
2	7.56418	38175.8	Bedrock	1044	36.5	1244.03	2687.45	2220.99	0	2220.99
3	7.56418	47811.7	Bedrock	1044	36.5	1689.59	3649.96	3521.75	0	3521.75
4	7.56418	54216.7	Bedrock	1044	36.5	2022.39	4368.91	4493.36	0	4493.36
5	7.56418	58861.5	Bedrock	1044	36.5	2288.27	4943.28	5269.57	0	5269.57
6	7.56418	62825.8	Bedrock	1044	36.5	2524.14	5452.83	5958.18	0	5958.18
7	7.56418	65360.3	Bedrock	1044	36.5	2705.31	5844.21	6487.12	0	6487.12
8	7.56418	65323.6	Bedrock	1044	36.5	2788	6022.83	6728.5	0	6728.5
9	7.56418	66660.5	Bedrock	1044	36.5	2915.3	6297.83	7100.15	0	7100.15
10	7.56418	68463.8	Bedrock	1044	36.5	3058.12	6606.37	7517.12	0	7517.12
11	7.56418	70071	Bedrock	1044	36.5	3192.82	6897.35	7910.35	0	7910.35
12	7.56418	71423.8	Bedrock	1044	36.5	3317.51	7166.71	8274.37	0	8274.37
13	7.56418	73629.6	Bedrock	1044	36.5	3478.1	7513.63	8743.2	0	8743.2
14	7.56418	69706.1	Bedrock	1044	36.5	3383.6	7309.49	8467.32	0	8467.32
15	7.56418	36828.5	Bedrock	1044	36.5	2039.42	4405.69	4543.07	0	4543.07
16	7.56418	31315.5	Bedrock	1044	36.5	1838.31	3971.25	3955.95	0	3955.95
17	7.56418	27511.1	Bedrock	1044	36.5	1704.82	3682.87	3566.22	0	3566.22
18	7.56418	9719	Bedrock	1044	36.5	928.672	2006.18	1300.31	0	1300.31
19	7.56418	10334	Bedrock	1044	36.5	976.299	2109.07	1439.36	0	1439.36
20	7.56418	9736.08	Bedrock	1044	36.5	968.634	2092.51	1416.97	0	1416.97
21	7.56418	8795.96	Bedrock	1044	36.5	944.531	2040.44	1346.61	0	1346.61
22	7.56418	7503.5	Bedrock	1044	36.5	902.576	1949.81	1224.13	0	1224.13
23	7.56418	5844.05	Bedrock	1044	36.5	840.9	1816.57	1044.07	0	1044.07
24	7.56418	3797.6	Bedrock	1044	36.5	757.013	1635.35	799.166	0	799.166
25	7.56418	1337.38	Bedrock	1044	36.5	647.517	1398.81	479.5	0	479.5

Interslice Data

Global Minimum Query (bishop simplified) - Safety Factor: 2.16027

Slice Number	X coordinate [ft]	Y coordinate - Bottom [ft]	Interslice Normal Force [lbs]	Interslice Shear Force [lbs]	Interslice Force Angle [degrees]

 BYER GEOTECHNICAL INC.	Project			BG 21898 HARVARD-WESTLAKE SECTION 1		
	Analysis Description			CALCULATE THE GROSS STABILITY BELOW THE SOIL NAIL WALLS		
	Drawn By		R. ZWEIGLER	Scale	Company	
	Date		2/12/15		File Name	
				BYER GEOTECHNICAL, INC.		
				21898 Section 1 ver 6 through soil nails.slim		

1	97.6748	829.628	0	0	0
2	105.239	785.894	-11477.7	0	0
3	112.803	768.711	17275.4	0	0
4	120.367	756.18	48627.5	0	0
5	127.932	746.178	78273.5	0	0
6	135.496	737.874	104723	0	0
7	143.06	730.839	127546	0	0
8	150.624	724.817	146147	0	0
9	158.188	719.642	159879	0	0
10	165.752	715.198	169376	0	0
11	173.317	711.404	174765	0	0
12	180.881	708.198	175974	0	0
13	188.445	705.535	172916	0	0
14	196.009	703.381	165447	0	0
15	203.573	701.708	154011	0	0
16	211.138	700.5	144074	0	0
17	218.702	699.743	133164	0	0
18	226.266	699.429	121389	0	0
19	233.83	699.555	114201	0	0
20	241.394	700.122	106000	0	0
21	248.958	701.136	97236.1	0	0
22	256.523	702.607	88109.7	0	0
23	264.087	704.553	78900.9	0	0
24	271.651	706.995	69990.6	0	0
25	279.215	709.964	61891.8	0	0
26	286.779	713.5	0	0	0

List Of Coordinates

Focus Search Window

X	Y
172.981	675
197.88	675
197.88	705.24
172.981	699.929

External Boundary

X	Y
223	741
207.5	742

 BYER GEOTECHNICAL INC.	<i>Project</i> BG 21898 HARVARD-WESTLAKE SECTION 1		
	<i>Analysis Description</i> CALCULATE THE GROSS STABILITY BELOW THE SOIL NAIL WALLS		
	<i>Drawn By</i> R. ZWEIGLER	<i>Scale</i>	<i>Company</i> BYER GEOTECHNICAL, INC.
	<i>Date</i> 2/12/15		<i>File Name</i> 21898 Section 1 ver 6 through soil nails.slim

200.137	798.701
200	802
185	801
163	805
151	810
147	815
131	820
119	825
101	830
91	835
77	840
67	845
56	850
46	855
35	860
19	865
0	873
-50	900
-108	925
-185	950
-240	957
-240	675
0	675
500	675
500	712.5
467	712.5
426	720
296.5	720
296.5	713.5
232	713.5
232	711.582
227.049	711.582

Material Boundary

X	Y
185	801
200.137	798.701



**BYER
GEOTECHNICAL
INC.**

<i>Project</i>			
BG 21898 HARVARD-WESTLAKE SECTION 1			
<i>Analysis Description</i>			
CALCULATE THE GROSS STABILITY BELOW THE SOIL NAIL WALLS			
<i>Drawn By</i>	R. ZWEIGLER	<i>Scale</i>	<i>Company</i>
			BYER GEOTECHNICAL, INC.
<i>Date</i>	2/12/15		<i>File Name</i>
			21898 Section 1 ver 6 through soil nails.slim

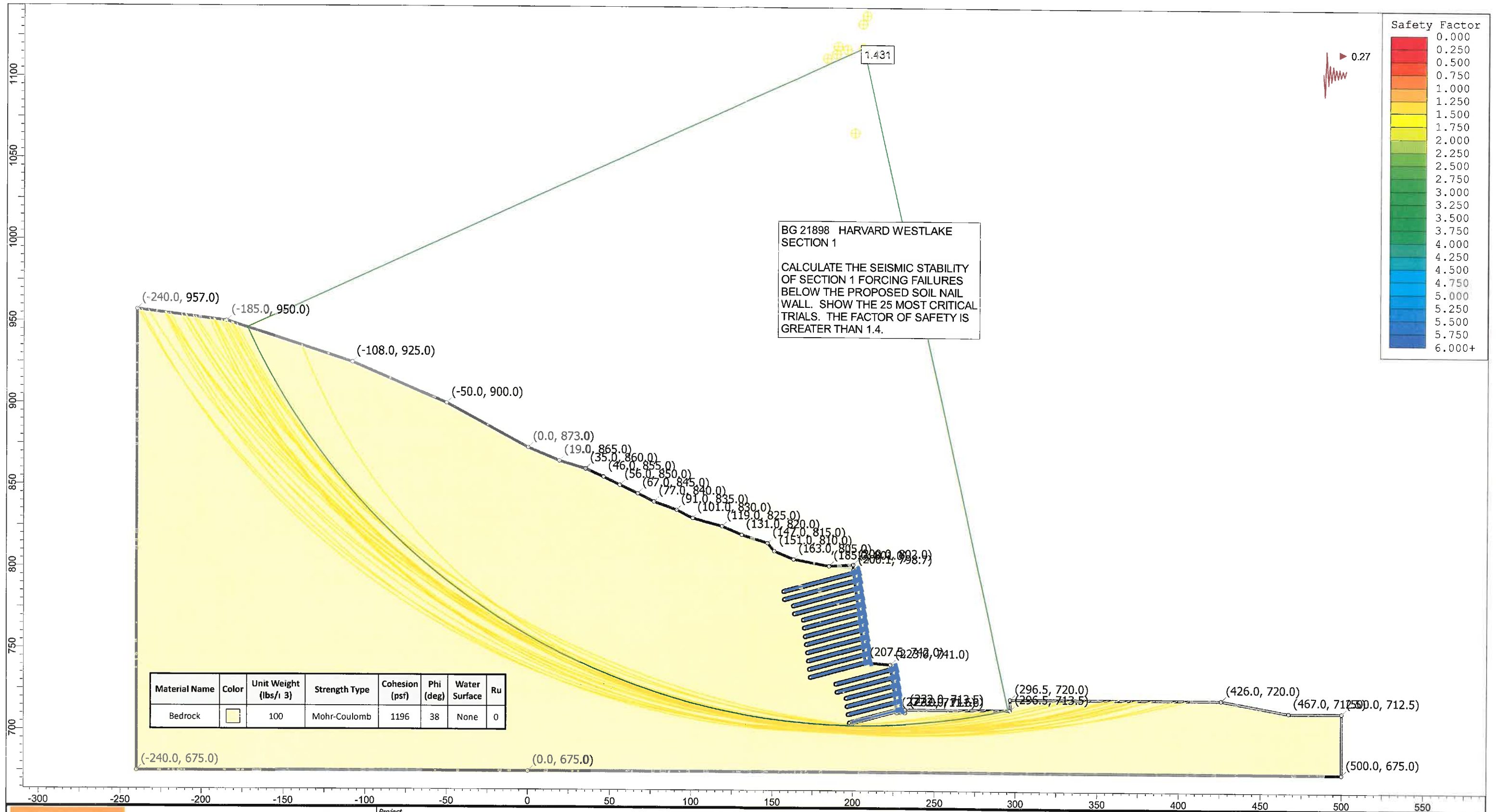

	Project BG 21898 HARVARD-WESTLAKE SECTION 1			
	Analysis Description CALCULATE THE SEISMIC STABILITY BELOW THE SOIL NAIL WALLS			
	Drawn By R. ZWEIGLER	Scale 1:661	Company BYER GEOTECHNICAL, INC.	
	Date 2/12/15	File Name 21898 Section 1 below soil nails EQ.slim		

Slide Analysis Information

BG 21898 HARVARD-WESTLAKE SECTION 1

Project Summary

File Name: 21898 Section 1 below soil nails EQ
Slide Modeler Version: 6.033
Project Title: BG 21898 HARVARD-WESTLAKE SECTION 1
Analysis: CALCULATE THE SEISMIC STABILITY BELOW THE SOIL NAIL WALLS
Author: R. ZWEIGLER
Company: BYER GEOTECHNICAL, INC.
Date Created: 2/12/15

General Settings

Units of Measurement: Imperial Units
Time Units: days
Permeability Units: feet/second
Failure Direction: Left to Right
Data Output: Standard
Maximum Material Properties: 20
Maximum Support Properties: 20

Analysis Options

Analysis Methods Used

Bishop simplified

Number of slices: 25
Tolerance: 0.005
Maximum number of iterations: 50
Check $m\alpha < 0.2$: Yes
Initial trial value of FS: 1
Steffensen Iteration: Yes

Groundwater Analysis

Groundwater Method: Water Surfaces
Pore Fluid Unit Weight: 62.4 lbs/ft³
Advanced Groundwater Method: None

 BYER GEOTECHNICAL INC.	<i>Project</i> BG 21898 HARVARD-WESTLAKE SECTION 1		
	<i>Analysis Description</i> CALCULATE THE SEISMIC STABILITY BELOW THE SOIL NAIL WALLS		
	<i>Drawn By</i> R. ZWEIGLER	<i>Scale</i>	<i>Company</i> BYER GEOTECHNICAL, INC.
	<i>Date</i> 2/12/15	<i>File Name</i> 21898 Section 1 below soil nails EQ.slim	

Random Numbers

Pseudo-random Seed: 10116
Random Number Generation Method: Park and Miller v.3

Surface Options

Surface Type: Circular
Search Method: Slope Search
Number of Surfaces: 5000
Upper Angle: Not Defined
Lower Angle: Not Defined
Composite Surfaces: Disabled
Reverse Curvature: Create Tension Crack
Minimum Elevation: Not Defined
Minimum Depth: Not Defined

Loading

Seismic Load Coefficient (Horizontal): 0.27

Material Properties

Property	Bedrock	Fill
Color	<input type="checkbox"/>	<input type="checkbox"/>
Strength Type	Mohr-Coulomb	Mohr-Coulomb
Unit Weight [lbs/ft ³]	100	120
Cohesion [psf]	1196	400
Friction Angle [deg]	38	30
Water Surface	None	None
Ru Value	0	0

Support Properties

Soil Nail

Support Type: Soil Nail
Force Application: Passive
Out-of-Plane Spacing: 5 ft
Tensile Capacity: 33333 lb
Plate Capacity: 37100 lb

 BYER GEOTECHNICAL INC.	<i>Project</i> BG 21898 HARVARD-WESTLAKE SECTION 1		
	<i>Analysis Description</i> CALCULATE THE SEISMIC STABILITY BELOW THE SOIL NAIL WALLS		
	<i>Drawn By</i> R. ZWEIGLER	<i>Scale</i>	<i>Company</i> BYER GEOTECHNICAL, INC.
	<i>Date</i> 2/12/15		<i>File Name</i> 21898 Section 1 below soil nails EQ.slim

Default Bond Strength: 2413 lb/ft
and Material Dependent

Bond Strength Dependency:

Material	Bond Strength (lbs/ft)
Bedrock	2413

Global Minimums

Method: bishop simplified

FS: 1.430500
Center: 205.073, 1118.757
Radius: 415.153
Left Slip Surface Endpoint: -172.385, 945.904
Right Slip Surface Endpoint: 295.179, 713.500
Resisting Moment=1.34448e+009 lb-ft
Driving Moment=9.39873e+008 lb-ft
Total Slice Area=37767.6 ft²

Valid / Invalid Surfaces

Method: bishop simplified

Number of Valid Surfaces: 2442
Number of Invalid Surfaces: 2558

Error Codes:

- Error Code -100 reported for 15 surfaces
- Error Code -101 reported for 1 surface
- Error Code -103 reported for 2445 surfaces
- Error Code -109 reported for 22 surfaces
- Error Code -112 reported for 75 surfaces

Error Codes

The following errors were encountered during the computation:

- 100 = Both surface / slope intersections are on the same horizontal surface. In general, this will give a very high or infinite factor of safety (zero driving force), if calculated.
- 101 = Only one (or zero) surface / slope intersections.
- 103 = Two surface / slope intersections, but one or more surface / nonslope external polygon intersections lie between them. This usually occurs when the slip surface extends past the bottom of the soil region, but may also occur on a benched slope model with two sets of Slope Limits.

 BYER GEOTECHNICAL INC.	<i>Project</i> BG 21898 HARVARD-WESTLAKE SECTION 1		
	<i>Analysis Description</i> CALCULATE THE SEISMIC STABILITY BELOW THE SOIL NAIL WALLS		
	<i>Drawn By</i> R. ZWEIGLER	<i>Scale</i>	<i>Company</i> BYER GEOTECHNICAL, INC.
	<i>Date</i> 2/12/15		<i>File Name</i> 21898 Section 1 below soil nails EQ.slim

-109 = Soiltype for slice base not located. This error should occur very rarely, if at all. It may occur if a very low number of slices is combined with certain soil geometries, such that the midpoint of a slice base is actually outside the soil region, even though the slip surface is wholly within the soil region.

-112 = The coefficient $M\text{-}\alpha = \cos(\alpha)(1 + \tan(\alpha)\tan(\phi)/F) < 0.2$ for the final iteration of the safety factor calculation. This screens out some slip surfaces which may not be valid in the context of the analysis, in particular, deep seated slip surfaces with many high negative base angle slices in the passive zone.

Slice Data

Global Minimum Query (bishop simplified) - Safety Factor: 1.4305

Slice Number	Width [ft]	Weight [lbs]	Base Material	Base Cohesion [psf]	Base Friction Angle [degrees]	Shear Stress [psf]	Shear Strength [psf]	Base Normal Stress [psf]	Pore Pressure [psf]	Effective Normal Stress [psf]
1	18.7025	28048.2	Bedrock	1196	38	806.464	1153.65	-54.2102	0	-54.2102
2	18.7025	77755.1	Bedrock	1196	38	1676.6	2398.38	1538.97	0	1538.97
3	18.7025	116824	Bedrock	1196	38	2468.94	3531.82	2989.71	0	2989.71
4	18.7025	147929	Bedrock	1196	38	3177.79	4545.83	4287.58	0	4287.58
5	18.7025	170643	Bedrock	1196	38	3765.81	5386.99	5364.22	0	5364.22
6	18.7025	188477	Bedrock	1196	38	4279.1	6121.25	6304.03	0	6304.03
7	18.7025	202139	Bedrock	1196	38	4721.08	6753.5	7113.28	0	7113.28
8	18.7025	209694	Bedrock	1196	38	5042.89	7213.85	7702.5	0	7702.5
9	18.7025	213817	Bedrock	1196	38	5291.86	7570.01	8158.38	0	8158.38
10	18.7025	216638	Bedrock	1196	38	5510.82	7883.23	8559.27	0	8559.27
11	18.7025	221015	Bedrock	1196	38	5764.81	8246.56	9024.28	0	9024.28
12	18.7025	223750	Bedrock	1196	38	5982.26	8557.63	9422.45	0	9422.45
13	18.7025	220996	Bedrock	1196	38	6067.86	8680.08	9579.2	0	9579.2
14	18.7025	217062	Bedrock	1196	38	6120.23	8754.99	9675.06	0	9675.06
15	18.7025	212913	Bedrock	1196	38	6162.85	8815.96	9753.09	0	9753.09
16	18.7025	209711	Bedrock	1196	38	6226.72	8907.33	9870.04	0	9870.04
17	18.7025	203775	Bedrock	1196	38	6216.07	8892.09	9850.55	0	9850.55
18	18.7025	191206	Bedrock	1196	38	6019.82	8611.35	9491.23	0	9491.23
19	18.7025	183597	Bedrock	1196	38	5950.72	8512.51	9364.7	0	9364.7
20	18.7025	181616	Bedrock	1196	38	6038.39	8637.91	9525.22	0	9525.22
21	18.7025	84105.1	Bedrock	1196	38	3318.09	4746.53	4544.48	0	4544.48
22	18.7025	28428.9	Bedrock	1196	38	1722.18	2463.58	1622.42	0	1622.42
23	18.7025	14064.1	Bedrock	1196	38	1322.58	1891.95	890.771	0	890.771
24	18.7025	9582.87	Bedrock	1196	38	1216.28	1739.89	696.141	0	696.141
25	18.7025	3469.19	Bedrock	1196	38	1051.17	1503.69	393.831	0	393.831

Interslice Data

Global Minimum Query (bishop simplified) - Safety Factor: 1.4305

 BYER GEOTECHNICAL INC.	Project		
	BG 21898 HARVARD-WESTLAKE SECTION 1		
	Analysis Description		
	CALCULATE THE SEISMIC STABILITY BELOW THE SOIL NAIL WALLS		
Drawn By	R. ZWEIGLER	Scale	Company
			BYER GEOTECHNICAL, INC.
Date	2/12/15		File Name
			21898 Section 1 below soil nails EQ.slim

Slice Number	X coordinate [ft]	Y coordinate - Bottom [ft]	Interslice Normal Force [lbs]	Interslice Shear Force [lbs]	Interslice Force Angle [degrees]
1	-172.385	945.904	0	0	0
2	-153.682	909.838	-9452.6	0	0
3	-134.98	880.604	25200.1	0	0
4	-116.277	855.914	84423.3	0	0
5	-97.5745	834.579	156454	0	0
6	-78.872	815.891	232403	0	0
7	-60.1694	799.384	307387	0	0
8	-41.4669	784.735	377945	0	0
9	-22.7643	771.709	440663	0	0
10	-4.06178	760.128	493986	0	0
11	14.6408	749.856	537415	0	0
12	33.3433	740.787	571203	0	0
13	52.0459	732.836	594743	0	0
14	70.7484	725.935	607128	0	0
15	89.451	720.029	608504	0	0
16	108.153	715.075	599140	0	0
17	126.856	711.038	579247	0	0
18	145.559	707.892	549103	0	0
19	164.261	705.614	509849	0	0
20	182.964	704.193	461532	0	0
21	201.666	703.618	403207	0	0
22	220.369	703.885	362693	0	0
23	239.071	704.998	336381	0	0
24	257.774	706.962	313713	0	0
25	276.476	709.79	291603	0	0
26	295.179	713.5	0	0	0

List Of Coordinates

Focus Search Window

X	Y
172.981	675
197.88	675
197.88	705.24
172.981	699.929

External Boundary

 BYER GEOTECHNICAL INC.	<i>Project</i> BG 21898 HARVARD-WESTLAKE SECTION 1		
	<i>Analysis Description</i> CALCULATE THE SEISMIC STABILITY BELOW THE SOIL NAIL WALLS		
	<i>Drawn By</i> R. ZWEIGLER	<i>Scale</i>	<i>Company</i> BYER GEOTECHNICAL, INC.
	<i>Date</i> 2/12/15		<i>File Name</i> 21898 Section 1 below soil nails EQ.slim

X	Y
223	741
207.5	742
200.137	798.701
200	802
185	801
163	805
151	810
147	815
131	820
119	825
101	830
91	835
77	840
67	845
56	850
46	855
35	860
19	865
0	873
-50	900
-108	925
-185	950
-240	957
-240	675
0	675
500	675
500	712.5
467	712.5
426	720
296.5	720
296.5	713.5
232	713.5
232	711.582
227.049	711.582

Material Boundary

X	Y
185	801
200.137	798.701



**BYER
GEOTECHNICAL
INC.**

<i>Project</i>			
BG 21898 HARVARD-WESTLAKE SECTION 1			
<i>Analysis Description</i>			
CALCULATE THE SEISMIC STABILITY BELOW THE SOIL NAIL WALLS			
<i>Drawn By</i>	R. ZWEIGLER	<i>Scale</i>	<i>Company</i>
			BYER GEOTECHNICAL, INC.
<i>Date</i>	2/12/15		<i>File Name</i>
			21898 Section 1 below soil nails EQ.slim

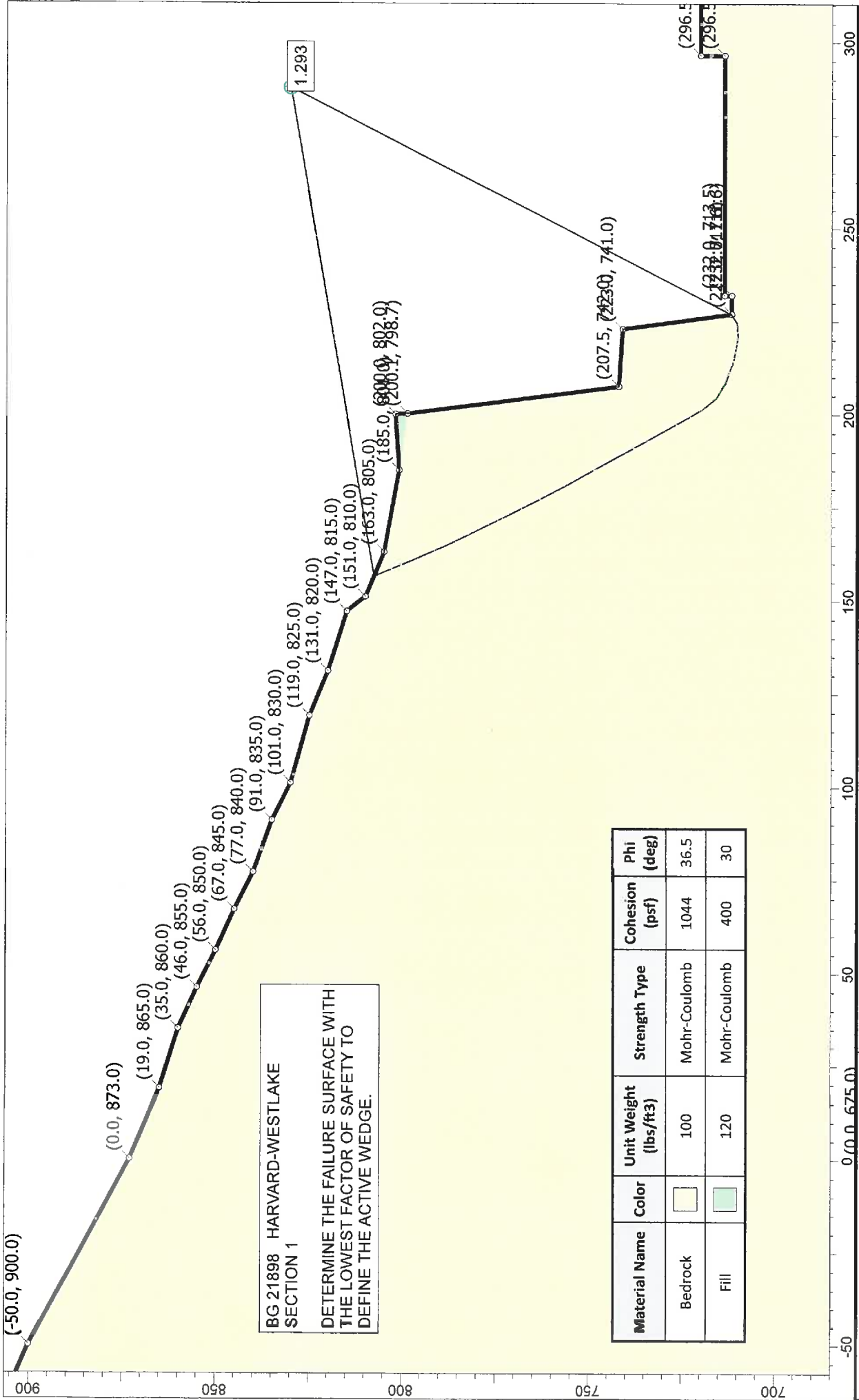

BYER GEOTECHNICAL INC.

Project: **BG 21898 HARVARD-WESTLAKE SECTION 1**

Analysis Description: **CALCULATE THE LOCATION OF THE MOST CRITICAL FAILURE THROUGH THE SOIL NAIL WALLS**

Drawn By: **R. ZWEIGLER** Scale: **1:428** Company: **BYER GEOTECHNICAL, INC.**

Date: **5/18/15** File Name: **21898 Section 1 active wedge.slim**

SLIDEINTERPRET 6.035

Slide Analysis Information

BG 21898 HARVARD-WESTLAKE SECTION 1

Project Summary

File Name: 21898 Section 1 active wedge
Slide Modeler Version: 6.035
Project Title: BG 21898 HARVARD-WESTLAKE SECTION 1
Analysis: CALCULATE THE LOCATION OF THE MOST CRITICAL FAILURE THROUGH THE SOIL NAIL WALLS
Author: R. ZWEIGLER
Company: BYER GEOTECHNICAL, INC.
Date Created: 5/18/15

General Settings

Units of Measurement: Imperial Units
Time Units: days
Permeability Units: feet/second
Failure Direction: Left to Right
Data Output: Standard
Maximum Material Properties: 20
Maximum Support Properties: 20

Analysis Options

Analysis Methods Used

Spencer

Number of slices: 25
Tolerance: 0.005
Maximum number of iterations: 50
Check $m\alpha < 0.2$: Yes
Initial trial value of FS: 1
Steffensen Iteration: Yes

Groundwater Analysis

Groundwater Method: Water Surfaces
Pore Fluid Unit Weight: 62.4 lbs/ft³
Advanced Groundwater Method: None

Random Numbers

 BYER GEOTECHNICAL INC.	<i>Project</i> BG 21898 HARVARD-WESTLAKE SECTION 1		
	<i>Analysis Description</i> CALCULATE THE LOCATION OF THE MOST CRITICAL FAILURE THROUGH THE SOIL NAIL WALLS		
	<i>Drawn By</i> R. ZWEIGLER	<i>Scale</i>	<i>Company</i> BYER GEOTECHNICAL, INC.
	<i>Date</i> 5/18/15	<i>File Name</i> 21898 Section 1 active wedge.slim	

SLIDEINTERPRET 6.035

Surface Options

Material Properties

Property	Bedrock	Fill
Color	<input type="checkbox"/>	<input type="checkbox"/>
Strength Type	Mohr-Coulomb	Mohr-Coulomb
Unit Weight [lbs/ft ³]	100	120
Cohesion [psf]	1044	400
Friction Angle [deg]	36.5	30
Water Surface	None	None
Ru Value	0	0

Global Minimums

Method: spencer

FS: 1.292680
 Axis Location: 287.730, 830.343
 Left Slip Surface Endpoint: 156.423, 807.740
 Right Slip Surface Endpoint: 227.028, 711.736
 Resisting Moment=3.54391e+007 lb-ft
 Driving Moment=2.74152e+007 lb-ft
 Resisting Horizontal Force=163031 lb
 Driving Horizontal Force=126119 lb
 Total Slice Area=2699.42 ft²

Global Minimum Coordinates

Method: spencer

X	Y
156.423	807.74
159.678	799.93
160.887	797.029
165.115	787.417
172.291	773.017
176.26	765.225
179.666	758.624
181.647	754.944
186.829	745.583

 BYER GEOTECHNICAL INC.	Project BG 21898 HARVARD-WESTLAKE SECTION 1		
	Analysis Description CALCULATE THE LOCATION OF THE MOST CRITICAL FAILURE THROUGH THE SOIL NAIL WALLS		
	Drawn By R. ZWEIGLER	Scale	Company BYER GEOTECHNICAL, INC.
	Date 5/18/15		File Name 21898 Section 1 active wedge.slim

188.793	742.036
193.569	733.409
199.412	722.855
201.62	719.132
204.653	715.446
208.257	713.356
213.961	711.345
215.568	710.904
220.504	709.998
224.572	710.16
227.028	711.736

Valid / Invalid Surfaces

Method: spencer

Number of Valid Surfaces: 1

Number of Invalid Surfaces: 0

Slice Data

Global Minimum Query (spencer) - Safety Factor: 1.29268

Slice Number	Width [ft]	Weight [lbs]	Base Material	Base Cohesion [psf]	Base Friction Angle [degrees]	Shear Stress [psf]	Shear Strength [psf]	Base Normal Stress [psf]	Pore Pressure [psf]	Effective Normal Stress [psf]
1	3.2552	1050.49	Bedrock	1044	36.5	364.514	471.2	-774.095	0	-774.095
2	1.20884	925.08	Bedrock	1044	36.5	480.147	620.676	-572.09	0	-572.09
3	4.22825	5454.77	Bedrock	1044	36.5	639.282	826.387	-294.087	0	-294.087
4	3.58771	7344.95	Bedrock	1044	36.5	906.323	1171.59	172.421	0	172.421
5	3.58771	9694	Bedrock	1044	36.5	1093.22	1413.19	498.929	0	498.929
6	3.96902	13426.7	Bedrock	1044	36.5	1302.73	1684.01	864.929	0	864.929
7	3.40619	13745.6	Bedrock	1044	36.5	1500.99	1940.3	1211.28	0	1211.28
8	1.98046	8913.13	Bedrock	1044	36.5	1671.19	2160.31	1508.61	0	1508.61
9	2.59134	12638	Bedrock	1044	36.5	1807.51	2336.53	1746.76	0	1746.76
10	2.59134	13777.8	Bedrock	1044	36.5	1939.29	2506.88	1976.96	0	1976.96
11	1.96374	11291.7	Bedrock	1044	36.5	2069.12	2674.71	2203.78	0	2203.78
12	2.38783	14726.1	Bedrock	1044	36.5	2194.07	2836.23	2422.06	0	2422.06
13	2.38783	15818.9	Bedrock	1044	36.5	2331.19	3013.48	2661.61	0	2661.61
14	2.92169	20842.3	Bedrock	1044	36.5	2483.67	3210.59	2927.99	0	2927.99
15	2.92169	22478.4	Bedrock	1044	36.5	2651.45	3427.47	3221.08	0	3221.08
16	2.20802	16569.4	Bedrock	1044	36.5	2679.54	3463.79	3270.16	0	3270.16
17	3.03291	17686.5	Bedrock	1044	36.5	2481.04	3207.19	2923.39	0	2923.39
18	3.60442	13067.1	Bedrock	1044	36.5	2130.41	2753.94	2310.85	0	2310.85
19	2.8518	8271.89	Bedrock	1044	36.5	1993.46	2576.9	2071.6	0	2071.6

 BYER GEOTECHNICAL INC.	<i>Project</i> BG 21898 HARVARD-WESTLAKE SECTION 1		
	<i>Analysis Description</i> CALCULATE THE LOCATION OF THE MOST CRITICAL FAILURE THROUGH THE SOIL NAIL WALLS		
	<i>Drawn By</i> R. ZWEIGLER	<i>Scale</i>	<i>Company</i> BYER GEOTECHNICAL, INC.
	<i>Date</i> 5/18/15		<i>File Name</i> 21898 Section 1 active wedge.slim

20	2.8518	8506.09	Bedrock	1044	36.5	2031.87	2626.56	2138.7	0	2138.7
21	1.60655	4885	Bedrock	1044	36.5	2127.72	2750.46	2306.14	0	2306.14
22	2.46799	7582.32	Bedrock	1044	36.5	2230.51	2883.33	2485.71	0	2485.71
23	2.46799	7654.74	Bedrock	1044	36.5	2245.19	2902.31	2511.36	0	2511.36
24	4.0686	11702.8	Bedrock	1044	36.5	2366.22	3058.76	2722.8	0	2722.8
25	2.45565	2384.21	Bedrock	1044	36.5	1877.19	2426.6	1868.47	0	1868.47

Interslice Data

Global Minimum Query (spencer) - Safety Factor: 1.29268

Slice Number	X coordinate [ft]	Y coordinate - Bottom [ft]	Interslice Normal Force [lbs]	Interslice Shear Force [lbs]	Interslice Force Angle [degrees]
1	156.423	807.74	0	0	0
2	159.678	799.93	-7232.68	723.268	-5.71059
3	160.887	797.029	-9472.44	947.244	-5.71059
4	165.115	787.417	-15002.5	1500.25	-5.71059
5	168.703	780.217	-17012.7	1701.27	-5.71059
6	172.291	773.017	-17342.7	1734.27	-5.71059
7	176.26	765.225	-15773.9	1577.39	-5.71059
8	179.666	758.624	-12890.9	1289.09	-5.71059
9	181.647	754.944	-10649.4	1064.94	-5.71059
10	184.238	750.264	-7156.85	715.685	-5.71059
11	186.829	745.583	-2928.22	292.822	-5.71059
12	188.793	742.036	825.658	-82.5658	-5.71059
13	191.181	737.722	6033.32	-603.332	-5.71059
14	193.569	733.409	11946.8	-1194.68	-5.71059
15	196.49	728.132	20142.2	-2014.22	-5.71059
16	199.412	722.855	29394.2	-2939.42	-5.71059
17	201.62	719.132	35650.7	-3565.07	-5.71059
18	204.653	715.446	38901.5	-3890.15	-5.71059
19	208.257	713.356	36052.8	-3605.28	-5.71059
20	211.109	712.351	32450.2	-3245.02	-5.71059
21	213.961	711.345	28805.6	-2880.56	-5.71059
22	215.568	710.904	26406.3	-2640.63	-5.71059
23	218.036	710.451	22026.6	-2202.66	-5.71059
24	220.504	709.998	17622.2	-1762.22	-5.71059
25	224.572	710.16	7555.65	-755.565	-5.71059
26	227.028	711.736	0	0	0

List Of Coordinates

External Boundary

 <p>BYER GEOTECHNICAL INC.</p>	Project			BG 21898 HARVARD-WESTLAKE SECTION 1		
	Analysis Description					CALCULATE THE LOCATION OF THE MOST CRITICAL FAILURE THROUGH THE SOIL NAIL WALLS
	Drawn By	R. ZWEIGLER	Scale	Company	BYER GEOTECHNICAL, INC.	
	Date	5/18/15			File Name	21898 Section 1 active wedge.slim

X	Y
223	741
207.5	742
200.137	798.701
200	802
185	801
163	805
151	810
147	815
131	820
119	825
101	830
91	835
77	840
67	845
56	850
46	855
35	860
19	865
0	873
-50	900
-108	925
-185	950
-240	957
-240	675
0	675
500	675
500	712.5
467	712.5
426	720
296.5	720
296.5	713.5
232	713.5
232	711.582
227.049	711.582

Material Boundary

X	Y
185	801
200.137	798.701

 <p>BYER GEOTECHNICAL INC.</p>	<i>Project</i>			BG 21898 HARVARD-WESTLAKE SECTION 1		
	<i>Analysis Description</i>					CALCULATE THE LOCATION OF THE MOST CRITICAL FAILURE THROUGH THE SOIL NAIL WALLS
	<i>Drawn By</i>	R. ZWEIGLER	<i>Scale</i>	<i>Company</i>	BYER GEOTECHNICAL, INC.	
	<i>Date</i>	5/18/15		<i>File Name</i>	21898 Section 1 active wedge.slim	
SLIDEINTERPRET 6.035						

BG 21898 HARVARD WESTLAKE
SECTION 1

CALCULATE THE MINIMUM REQUIRED
EFP APPLIED TO THE FACE OF THE
PROPOSED SOIL NAIL CONFIGURATION
TO ACHIEVE A MINIMUM FACTOR OF
SAFETY OF 1.5.

THE RESULTS INDICATE THAT AN EFP
OF 10 PCF WILL ACHIEVE A FACTOR OF
SAFETY IN EXCESS OF 1.5.

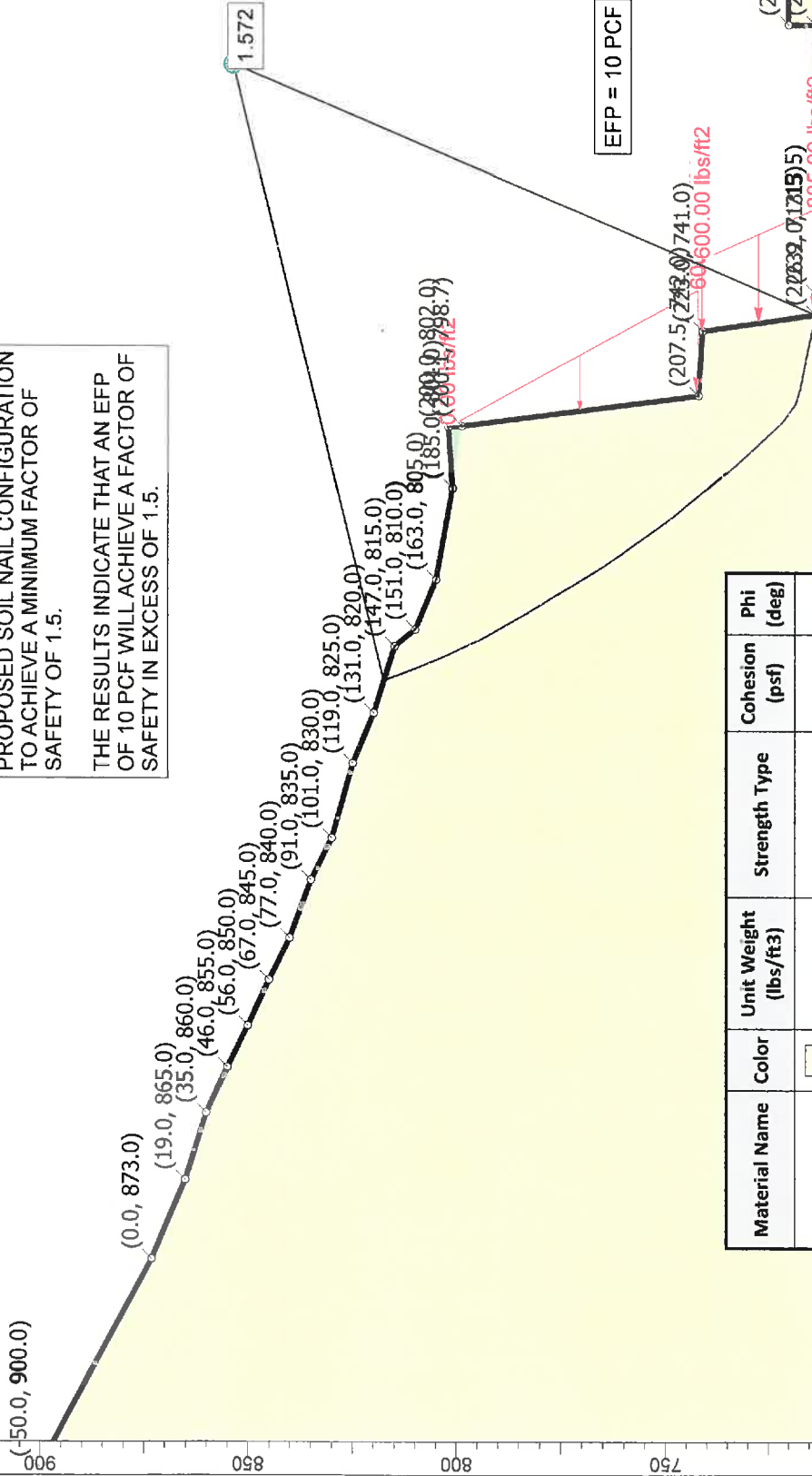

BG 21898 HARVARD-WESTLAKE SECTION 1

ANALYSIS DESCRIPTION: CALCULATE THE MINIMUM REQUIRED EFP APPLIED TO SOIL NAIL WALLS TO ACHIEVE FS=1.5
 DRAWN BY: R. ZWEIGLER
 SCALE: 1:505
 COMPANY: BYER GEOTECHNICAL, INC.
 FILE NAME: 21898 Section 1 efp.slm

BYER
GEOTECHNICAL
INC.



Slide Analysis Information

BG 21898 HARVARD-WESTLAKE SECTION 1

Project Summary

File Name: 21898 Section 1 efp
Slide Modeler Version: 6.035
Project Title: BG 21898 HARVARD-WESTLAKE SECTION 1
Analysis: CALCULATE THE MINIMUM REQUIRED EFP APPLIED TO SOIL NAIL WALLS TO ACHIEVE FS=1.5
Author: R. ZWEIGLER
Company: BYER GEOTECHNICAL, INC.
Date Created: 5/18/15

General Settings

Units of Measurement: Imperial Units
Time Units: days
Permeability Units: feet/second
Failure Direction: Left to Right
Data Output: Standard
Maximum Material Properties: 20
Maximum Support Properties: 20

Analysis Options

Analysis Methods Used

Spencer

Number of slices: 25
Tolerance: 0.005
Maximum number of iterations: 50
Check $m\alpha < 0.2$: Yes
Initial trial value of FS: 1
Steffensen Iteration: Yes

Groundwater Analysis

Groundwater Method: Water Surfaces
Pore Fluid Unit Weight: 62.4 lbs/ft³
Advanced Groundwater Method: None

Random Numbers

 BYER GEOTECHNICAL INC. <small>SLIDEINTERPRET 6.035</small>	<i>Project</i> BG 21898 HARVARD-WESTLAKE SECTION 1		
	<i>Analysis Description</i> CALCULATE THE MINIMUM REQUIRED EFP APPLIED TO SOIL NAIL WALLS TO ACHIEVE FS=1.5		
	<i>Drawn By</i> R. ZWEIGLER	<i>Scale</i>	<i>Company</i> BYER GEOTECHNICAL, INC.
	<i>Date</i> 5/18/15	<i>File Name</i> 21898 Section 1 efp.slim	

Surface Options

Loading

2 Distributed Loads present

Distributed Load 1

Distribution: Triangular
 Magnitude 1 [psf]: 0
 Magnitude 2 [psf]: 600
 Orientation: Horizontal

Distributed Load 2

Distribution: Triangular
 Magnitude 1 [psf]: 600
 Magnitude 2 [psf]: 885
 Orientation: Horizontal

Material Properties

Property	Bedrock	Fill
Color	<input type="checkbox"/>	<input type="checkbox"/>
Strength Type	Mohr-Coulomb	Mohr-Coulomb
Unit Weight [lbs/ft ³]	100	120
Cohesion [psf]	1044	400
Friction Angle [deg]	36.5	30
Water Surface	None	None
Ru Value	0	0

Global Minimums

Method: spencer

FS: 1.572300
 Axis Location: 286.892, 853.688
 Left Slip Surface Endpoint: 138.808, 817.560
 Right Slip Surface Endpoint: 226.944, 713.544
 Resisting Moment=5.29737e+007 lb-ft
 Driving Moment=3.36918e+007 lb-ft
 Resisting Horizontal Force=231535 lb

 BYER GEOTECHNICAL INC.	<i>Project</i> BG 21898 HARVARD-WESTLAKE SECTION 1		
	<i>Analysis Description</i> CALCULATE THE MINIMUM REQUIRED EFP APPLIED TO SOIL NAIL WALLS TO ACHIEVE FS=1.5		
	<i>Drawn By</i> R. ZWEIGLER	<i>Scale</i>	<i>Company</i> BYER GEOTECHNICAL, INC.
	<i>Date</i> 5/18/15	<i>File Name</i> 21898 Section 1 efp.slim	

Global Minimum Coordinates

Method: spencer

X	Y
138.808	817.56
141.378	810.587
144.494	803.088
148.703	794.097
154.289	784.17
162.517	770.723
165.862	765.262
168.191	761.924
177.62	748.839
177.963	748.393
182.98	742.269
190.62	733.008
194.362	728.842
201.411	721.227
205.463	718.365
209.264	717.182
212.887	716.433
219	715.172
224.521	714.039
226.944	713.544

Valid / Invalid Surfaces

Method: spencer

Number of Valid Surfaces: 1
 Number of Invalid Surfaces: 0

Slice Data

Global Minimum Query (spencer) - Safety Factor: 1.5723

Slice Number	Width [ft]	Weight [lbs]	Base Material	Base Cohesion [psf]	Base Friction Angle [degrees]	Shear Stress [psf]	Shear Strength [psf]	Base Normal Stress [psf]	Pore Pressure [psf]	Effective Normal Stress [psf]
1	2.5697	792.68	Bedrock	1044	36.5	306.43	481.8	-759.771	0	-759.771
2	3.11649	2939.51	Bedrock	1044	36.5	488.998	768.851	-371.842	0	-371.842

 BYER GEOTECHNICAL INC.	Project		BG 21898 HARVARD-WESTLAKE SECTION 1		
	Analysis Description				CALCULATE THE MINIMUM REQUIRED EFP APPLIED TO SOIL NAIL WALLS TO ACHIEVE FS=1.5
	Drawn By	R. ZWEIGLER	Scale	Company	BYER GEOTECHNICAL, INC.
	Date	5/18/15	File Name	21898 Section 1 efp.slim	

3	4.2085	6821.95	Bedrock	1044	36.5	698.792	1098.71	73.9369	0	73.9369
4	2.79318	5459.88	Bedrock	1044	36.5	859.48	1351.36	415.373	0	415.373
5	2.79318	6301.27	Bedrock	1044	36.5	942.596	1482.04	591.983	0	591.983
6	4.11382	11092.5	Bedrock	1044	36.5	1103.84	1735.57	934.605	0	934.605
7	4.11382	13153.5	Bedrock	1044	36.5	1246.49	1959.86	1237.71	0	1237.71
8	3.34539	12310.8	Bedrock	1044	36.5	1384.71	2177.18	1531.4	0	1531.4
9	2.32852	9471.19	Bedrock	1044	36.5	1573.08	2473.36	1931.67	0	1931.67
10	4.71437	21202.8	Bedrock	1044	36.5	1721.85	2707.27	2247.78	0	2247.78
11	4.71437	23883	Bedrock	1044	36.5	1893.21	2976.69	2611.88	0	2611.88
12	0.34354	1844.62	Bedrock	1044	36.5	2031.72	3194.47	2906.2	0	2906.2
13	5.01712	28342.8	Bedrock	1044	36.5	2161.81	3399.02	3182.62	0	3182.62
14	3.81996	23374.4	Bedrock	1044	36.5	2314.54	3639.15	3507.14	0	3507.14
15	3.81996	25244.6	Bedrock	1044	36.5	2468.52	3881.26	3834.35	0	3834.35
16	3.74147	26527.6	Bedrock	1044	36.5	2690.12	4229.67	4305.18	0	4305.18
17	3.52469	26537.2	Bedrock	1044	36.5	2857.13	4492.27	4660.08	0	4660.08
18	3.52469	26850	Bedrock	1044	36.5	2878.03	4525.12	4704.46	0	4704.46
19	4.05234	21677.1	Bedrock	1044	36.5	2314.9	3639.72	3507.9	0	3507.9
20	3.80093	10795.4	Bedrock	1044	36.5	1615.52	2540.08	2021.83	0	2021.83
21	3.6227	9042.85	Bedrock	1044	36.5	1624.06	2553.51	2039.99	0	2039.99
22	3.05631	7774.1	Bedrock	1044	36.5	1644.25	2585.26	2082.9	0	2082.9
23	3.05631	7906.58	Bedrock	1044	36.5	1662.41	2613.81	2121.47	0	2121.47
24	5.52124	13819.7	Bedrock	1044	36.5	1574.74	2475.96	1935.18	0	1935.18
25	2.42275	1983.38	Bedrock	1044	36.5	687.524	1080.99	49.9941	0	49.9941

Interslice Data

Global Minimum Query (spencer) - Safety Factor: 1.5723

Slice Number	X coordinate [ft]	Y coordinate - Bottom [ft]	Interslice Normal Force [lbs]	Interslice Shear Force [lbs]	Interslice Force Angle [degrees]
1	138.808	817.56	0	0	0
2	141.378	810.587	-6084.9	608.49	-5.71059
3	144.494	803.088	-10397.4	1039.74	-5.71059
4	148.703	794.097	-12673.4	1267.34	-5.71059
5	151.496	789.133	-13012.5	1301.25	-5.71059
6	154.289	784.17	-12707.2	1270.72	-5.71059
7	158.403	777.446	-10964.1	1096.41	-5.71059
8	162.517	770.723	-7769.72	776.972	-5.71059
9	165.862	765.262	-4040.5	404.05	-5.71059
10	168.191	761.924	-1254.39	125.439	-5.71059
11	172.905	755.382	5333.77	-533.377	-5.71059
12	177.62	748.839	13496.2	-1349.62	-5.71059
13	177.963	748.393	14094.2	-1409.42	-5.71059
14	182.98	742.269	22739.8	-2273.98	-5.71059

 <p>BYER GEOTECHNICAL INC.</p>	Project			BG 21898 HARVARD-WESTLAKE SECTION 1		
	Analysis Description					CALCULATE THE MINIMUM REQUIRED EFP APPLIED TO SOIL NAIL WALLS TO ACHIEVE FS=1.5
	Drawn By		R. ZWEIGLER	Scale	Company	
	Date		5/18/15	File Name		21898 Section 1 efp.slim

SLIDEINTERPRET 6.035

15	186.8	737.639	30137.6	-3013.76	-5.71059
16	190.62	733.008	38462.1	-3846.21	-5.71059
17	194.362	728.842	46332.4	-4633.24	-5.71059
18	197.886	725.035	54006.4	-5400.64	-5.71059
19	201.411	721.227	60912.5	-6091.25	-5.71059
20	205.463	718.365	52538.8	-5253.88	-5.71059
21	209.264	717.182	40540.7	-4054.07	-5.71059
22	212.887	716.433	36186.1	-3618.61	-5.71059
23	215.943	715.802	32474.3	-3247.43	-5.71059
24	219	715.172	28731.4	-2873.14	-5.71059
25	224.521	714.039	15224.5	-1522.45	-5.71059
26	226.944	713.544	0	0	0

List Of Coordinates

Distributed Load

X	Y
200	802
200.137	798.701
207.5	742

Distributed Load

X	Y
223	741
226.95	713.5

External Boundary

X	Y
223	741
207.5	742
200.137	798.701
200	802
185	801
163	805
151	810
147	815
131	820
119	825
101	830
91	835
77	840

 BYER GEOTECHNICAL INC.	<i>Project</i> BG 21898 HARVARD-WESTLAKE SECTION 1			
	<i>Analysis Description</i> CALCULATE THE MINIMUM REQUIRED EFP APPLIED TO SOIL NAIL WALLS TO ACHIEVE FS=1.5			
	<i>Drawn By</i> R. ZWEIGLER	<i>Scale</i>	<i>Company</i> BYER GEOTECHNICAL, INC.	
	<i>Date</i> 5/18/15		<i>File Name</i> 21898 Section 1 efp.slim	

67	845
56	850
46	855
35	860
19	865
0	873
-50	900
-108	925
-185	950
-240	957
-240	675
0	675
500	675
500	712.5
467	712.5
426	720
296.5	720
296.5	713.5
232	713.5
226.95	713.5

Material Boundary

X	Y
185	801
200.137	798.701

 BYER GEOTECHNICAL INC.	<i>Project</i>			BG 21898 HARVARD-WESTLAKE SECTION 1		
	<i>Analysis Description</i>					CALCULATE THE MINIMUM REQUIRED EFP APPLIED TO SOIL NAIL WALLS TO ACHIEVE FS=1.5
	<i>Drawn By</i>	R. ZWEIGLER	<i>Scale</i>	<i>Company</i>	BYER GEOTECHNICAL, INC.	
	<i>Date</i>	5/18/15		<i>File Name</i>	21898 Section 1 efp.slim	



BG 21898 HARVARD WESTLAKE
SECTION 1

CALCULATE THE MINIMUM REQUIRED EFP TO GENERATE A FACTOR OF SAFETY OF 1.0 UNDER SEISMIC LOADING APPLIED ON THE FACE OF THE PROPOSED SOIL NAIL RETAINING WALLS. NOTE: THE SEARCH WAS LIMITED TO THE UPSLOPE DISTANCE RESULTING IN THE MOST CRITICAL FAILURE UNDER STATIC CONDITIONS.

THE RESULTS INDICATE THAT AN EFP OF 10 PCF WILL ACHIEVE A FACTOR OF SAFETY OF GREATER THAN 1.0 UNDER SEISMIC LOADING.

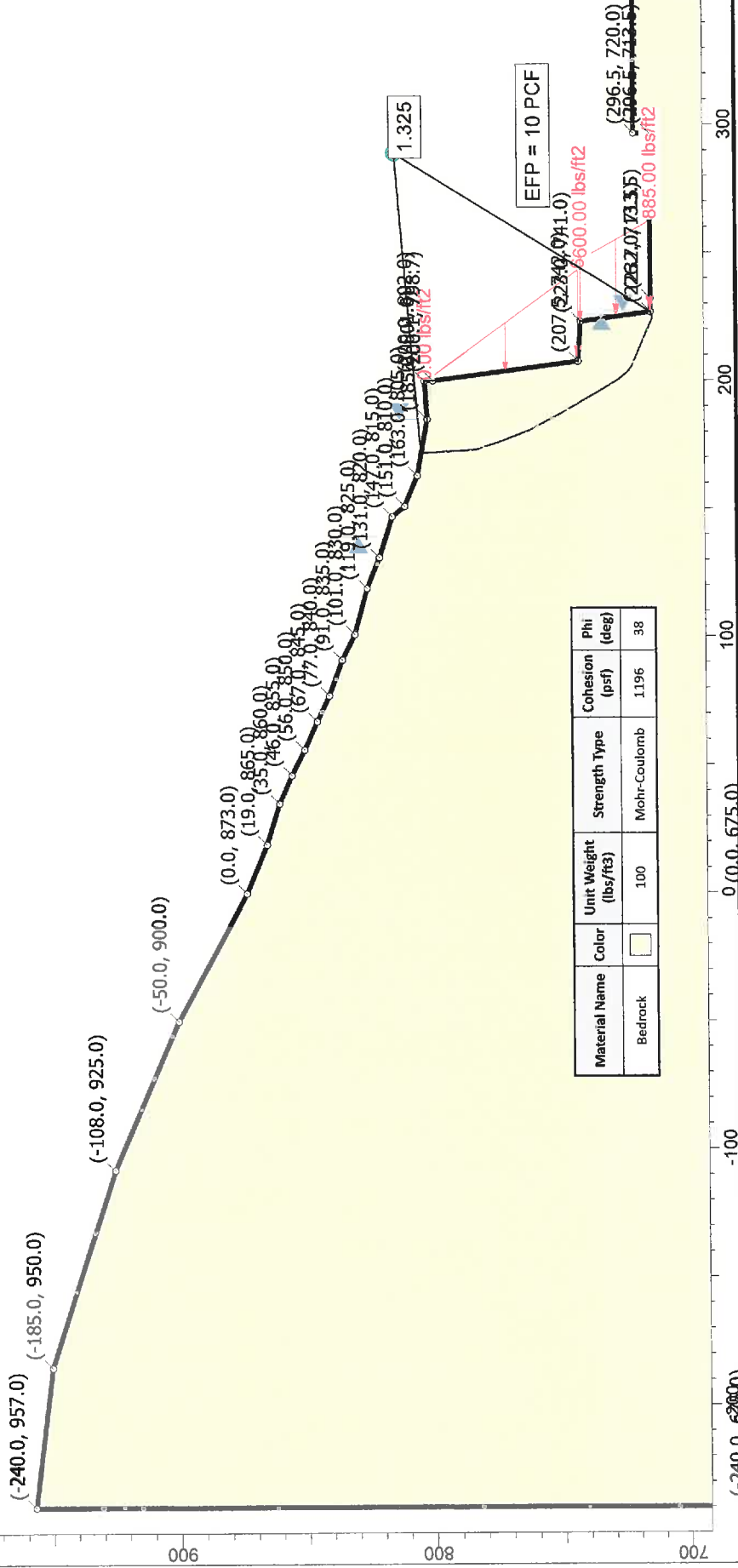

BG 21898 HARVARD-WESTLAKE SECTION 1

CALCULATE THE MINIMUM REQUIRED EFP APPLIED TO SOIL NAIL WALLS TO ACHIEVE FS=1.0 (SEISMIC)

BYER GEOTECHNICAL, INC.

21898 Section 1 efp EQ.slm

BYER
GEOTECHNICAL
INC.



Slide Analysis Information

BG 21898 HARVARD-WESTLAKE SECTION 1

Project Summary

File Name: 21898 Section 1 efp EQ
Slide Modeler Version: 6.035
Project Title: BG 21898 HARVARD-WESTLAKE SECTION 1
Analysis: CALCULATE THE MINIMUM REQUIRED EFP TO REPRESENT SOIL NAIL EARTH BLOCK (SEISMIC)
Author: R. ZWEIGLER
Company: BYER GEOTECHNICAL, INC.
Date Created: 5/18/15

General Settings

Units of Measurement: Imperial Units
Time Units: days
Permeability Units: feet/second
Failure Direction: Left to Right
Data Output: Standard
Maximum Material Properties: 20
Maximum Support Properties: 20

Analysis Options

Analysis Methods Used

Spencer

Number of slices: 25
Tolerance: 0.005
Maximum number of iterations: 50
Check $m\alpha < 0.2$: Yes
Initial trial value of FS: 1
Steffensen Iteration: Yes

Groundwater Analysis

Groundwater Method: Water Surfaces
Pore Fluid Unit Weight: 62.4 lbs/ft³
Advanced Groundwater Method: None

Random Numbers

 BYER GEOTECHNICAL INC.	<i>Project</i> BG 21898 HARVARD-WESTLAKE SECTION 1		
	<i>Analysis Description</i> CALCULATE THE MINIMUM REQUIRED EFP TO REPRESENT SOIL NAIL EARTH BLOCK (SEISMIC)		
	<i>Drawn By</i> R. ZWEIGLER	<i>Scale</i>	<i>Company</i> BYER GEOTECHNICAL, INC.
	<i>Date</i> 5/18/15	<i>File Name</i> 21898 Section 1 efp EQ.slim	

SLIDEINTERPRET 6.035

Surface Options

Loading

Seismic Load Coefficient (Horizontal): 0.29
 2 Distributed Loads present

Distributed Load 1

Distribution: Triangular
 Magnitude 1 [psf]: 0
 Magnitude 2 [psf]: 600
 Orientation: Horizontal

Distributed Load 2

Distribution: Triangular
 Magnitude 1 [psf]: 885
 Magnitude 2 [psf]: 600
 Orientation: Horizontal

Material Properties

Property	Bedrock	Fill
Color	<input type="checkbox"/>	<input type="checkbox"/>
Strength Type	Mohr-Coulomb	Mohr-Coulomb
Unit Weight [lbs/ft ³]	100	120
Cohesion [psf]	1196	400
Friction Angle [deg]	38	30
Water Surface	None	None
Ru Value	0	0

Global Minimums

Method: spencer

FS: 1.324660
 Axis Location: 289.129, 813.408
 Left Slip Surface Endpoint: 171.742, 803.410
 Right Slip Surface Endpoint: 226.695, 713.500
 Resisting Moment=2.72497e+007 lb-ft
 Driving Moment=2.05711e+007 lb-ft

 BYER GEOTECHNICAL INC.	<i>Project</i> BG 21898 HARVARD-WESTLAKE SECTION 1		
	<i>Analysis Description</i> CALCULATE THE MINIMUM REQUIRED EFP TO REPRESENT SOIL NAIL EARTH BLOCK (SEISMIC)		
	<i>Drawn By</i> R. ZWEIGLER	<i>Scale</i>	<i>Company</i> BYER GEOTECHNICAL, INC.
	<i>Date</i> 5/18/15	<i>File Name</i> 21898 Section 1 efp EQ.slim	

Resisting Horizontal Force=135650 lb
 Driving Horizontal Force=102403 lb
 Total Slice Area=2163.44 ft²

Global Minimum Coordinates

Method: spencer

X	Y
171.742	803.41
173.061	782.182
176.261	772.386
180.556	761.381
181.695	759.144
186.524	750.159
187.954	747.598
190.289	743.489
194.3	736.607
199.731	727.595
201.097	725.519
203.237	722.933
205.222	721.325
207.52	720.3
211.978	718.311
217.412	715.886
217.706	715.755
224.015	712.94
225.532	712.95
226.695	713.5

Valid / Invalid Surfaces

Method: spencer

Number of Valid Surfaces: 1
 Number of Invalid Surfaces: 0

Slice Data

Global Minimum Query (spencer) - Safety Factor: 1.32466

Slice Number	Width [ft]	Weight [lbs]	Base Material	Base Cohesion [psf]	Base Friction Angle [degrees]	Shear Stress [psf]	Shear Strength [psf]	Base Normal Stress [psf]	Pore Pressure [psf]	Effective Normal Stress [psf]
1	1.31903	1384.23	Bedrock	1196	38	9.69305	12.84	-1514.37	0	-1514.37

 BYER GEOTECHNICAL INC.	Project		BG 21898 HARVARD-WESTLAKE SECTION 1		
	Analysis Description				CALCULATE THE MINIMUM REQUIRED EFP TO REPRESENT SOIL NAIL EARTH BLOCK (SEISMIC)
	Drawn By		R. ZWEIGLER	Scale	Company
	Date		5/18/15	File Name	21898 Section 1 efp EQ.slim

2	3.20006	8190.78	Bedrock	1196	38	852.074	1128.71	-86.13	0	-86.13
3	2.14708	7033.55	Bedrock	1196	38	1149.27	1522.39	417.757	0	417.757
4	2.14708	8131.13	Bedrock	1196	38	1283.33	1699.97	645.059	0	645.059
5	1.1392	4721.06	Bedrock	1196	38	1603.49	2124.08	1187.88	0	1187.88
6	2.41466	10741.3	Bedrock	1196	38	1743.22	2309.18	1424.81	0	1424.81
7	2.41466	11754.1	Bedrock	1196	38	1872.41	2480.31	1643.85	0	1643.85
8	1.43028	7490.19	Bedrock	1196	38	2024.6	2681.91	1901.88	0	1901.88
9	2.33439	13051.9	Bedrock	1196	38	2153.62	2852.81	2120.61	0	2120.61
10	4.01154	24774	Bedrock	1196	38	2367.27	3135.83	2482.86	0	2482.86
11	2.71516	18414.8	Bedrock	1196	38	2601.32	3445.86	2879.7	0	2879.7
12	2.71516	19719.6	Bedrock	1196	38	2757.13	3652.26	3143.86	0	3143.86
13	1.36636	9636.21	Bedrock	1196	38	2784.53	3688.56	3190.33	0	3190.33
14	2.14011	12593.4	Bedrock	1196	38	2591.64	3433.04	2863.27	0	2863.27
15	1.98467	8942.57	Bedrock	1196	38	2338.95	3098.32	2434.86	0	2434.86
16	2.29801	6867.47	Bedrock	1196	38	1912.82	2533.83	1712.34	0	1712.34
17	2.22909	4931.67	Bedrock	1196	38	1726.22	2286.66	1395.98	0	1395.98
18	2.22909	5121.32	Bedrock	1196	38	1766.64	2340.2	1464.51	0	1464.51
19	2.71701	6498.78	Bedrock	1196	38	1811.48	2399.6	1540.54	0	1540.54
20	2.71701	6780.56	Bedrock	1196	38	1860.75	2464.86	1624.07	0	1624.07
21	0.294018	750.645	Bedrock	1196	38	1888.05	2501.03	1670.36	0	1670.36
22	3.15446	8261.13	Bedrock	1196	38	1919.32	2542.44	1723.37	0	1723.37
23	3.15446	8260.96	Bedrock	1196	38	1848	2447.97	1602.45	0	1602.45
24	1.51729	2253.96	Bedrock	1196	38	1400.98	1855.83	844.539	0	844.539
25	1.1628	535.103	Bedrock	1196	38	1030.47	1365.02	216.331	0	216.331

Interslice Data

Global Minimum Query (spencer) - Safety Factor: 1.32466

Slice Number	X coordinate [ft]	Y coordinate - Bottom [ft]	Interslice Normal Force [lbs]	Interslice Shear Force [lbs]	Interslice Force Angle [degrees]
1	171.742	803.41	0	0	0
2	173.061	782.182	-31759.1	3175.91	-5.71059
3	176.261	772.386	-32954.1	3295.41	-5.71059
4	178.409	766.884	-31083.3	3108.33	-5.71059
5	180.556	761.381	-27931.4	2793.14	-5.71059
6	181.695	759.144	-25731	2573.1	-5.71059
7	184.109	754.651	-20424.3	2042.43	-5.71059
8	186.524	750.159	-14151.7	1415.17	-5.71059
9	187.954	747.598	-10004.9	1000.49	-5.71059
10	190.289	743.489	-2534.24	253.424	-5.71059
11	194.3	736.607	12240.8	-1224.08	-5.71059
12	197.015	732.101	23493.6	-2349.36	-5.71059
13	199.731	727.595	35892.2	-3589.22	-5.71059

 BYER GEOTECHNICAL INC.	Project			BG 21898 HARVARD-WESTLAKE SECTION 1													
	Analysis Description						CALCULATE THE MINIMUM REQUIRED EFP TO REPRESENT SOIL NAIL EARTH BLOCK (SEISMIC)										
	Drawn By			R. ZWEIGLER			Scale			Company			BYER GEOTECHNICAL, INC.				
	Date						5/18/15						File Name			21898 Section 1 efp EQ.slim	

14	201.097	725.519	40931.9	-4093.19	-5.71059
15	203.237	722.933	43299.2	-4329.92	-5.71059
16	205.222	721.325	39801.1	-3980.11	-5.71059
17	207.52	720.3	30090	-3009	-5.71059
18	209.749	719.305	29060.8	-2906.08	-5.71059
19	211.978	718.311	28064.6	-2806.46	-5.71059
20	214.695	717.098	26895.1	-2689.51	-5.71059
21	217.412	715.886	25774.8	-2577.48	-5.71059
22	217.706	715.755	25656.5	-2565.65	-5.71059
23	220.86	714.347	24423.5	-2442.35	-5.71059
24	224.015	712.94	18374.2	-1837.42	-5.71059
25	225.532	712.95	8498.1	-849.81	-5.71059
26	226.695	713.5	0	0	0

List Of Coordinates

Distributed Load

X	Y
200	802
200.137	798.701
207.5	742

Distributed Load

X	Y
226.695	713.5
223	741

External Boundary

X	Y
223	741
207.5	742
200.137	798.701
200	802
185	801
163	805
151	810
147	815
131	820
119	825
101	830
91	835

 BYER GEOTECHNICAL INC.	<i>Project</i>			
	BG 21898 HARVARD-WESTLAKE SECTION 1			
	<i>Analysis Description</i>			
	CALCULATE THE MINIMUM REQUIRED EFP TO REPRESENT SOIL NAIL EARTH BLOCK (SEISMIC)			
<i>Drawn By</i>	R. ZWEIGLER	<i>Scale</i>	<i>Company</i>	BYER GEOTECHNICAL, INC.
<i>Date</i>	5/18/15		<i>File Name</i>	21898 Section 1 efp EQ.slim

77	840
67	845
56	850
46	855
35	860
19	865
0	873
-50	900
-108	925
-185	950
-240	957
-240	675
0	675
500	675
500	712.5
467	712.5
426	720
296.5	720
296.5	713.5
232	713.5
226.695	713.5

Material Boundary

X	Y
185	801
200.137	798.701

 <p>BYER GEOTECHNICAL INC.</p>	<i>Project</i>			BG 21898 HARVARD-WESTLAKE SECTION 1		
	<i>Analysis Description</i>					CALCULATE THE MINIMUM REQUIRED EFP TO REPRESENT SOIL NAIL EARTH BLOCK (SEISMIC)
	<i>Drawn By</i>	R. ZWEIGLER	<i>Scale</i>	<i>Company</i>	BYER GEOTECHNICAL, INC.	
	<i>Date</i>	5/18/15		<i>File Name</i>	21898 Section 1 efp EQ.slim	
SLIDEINTERPRET 6.035						

1.514

BG 21898 HARVARD WESTLAKE
SECTION 1
CALCULATE THE MINIMUM REQUIRED
EFP TO GENERATE A FACTOR OF SAFETY
OF 1.5, APPLIED SOAS TO REPRESENT
THE MASS OF EARTH CONSISTING OF
A SOIL NAIL RETAINING WALL.
THE RESULTS INDICATE THAT AN EFP
OF 30 PCF WILL ACHIEVE A FACTOR OF
SAFETY OF GREATER THAN 1.5.

Material Name	Color	Unit Weight (lbs/ft3)	Strength Type	Cohesion (psf)	Phi (deg)
Bedrock	<input type="checkbox"/>	100	Mohr-Coulomb	1044	36.5

EFP = 30 PCF

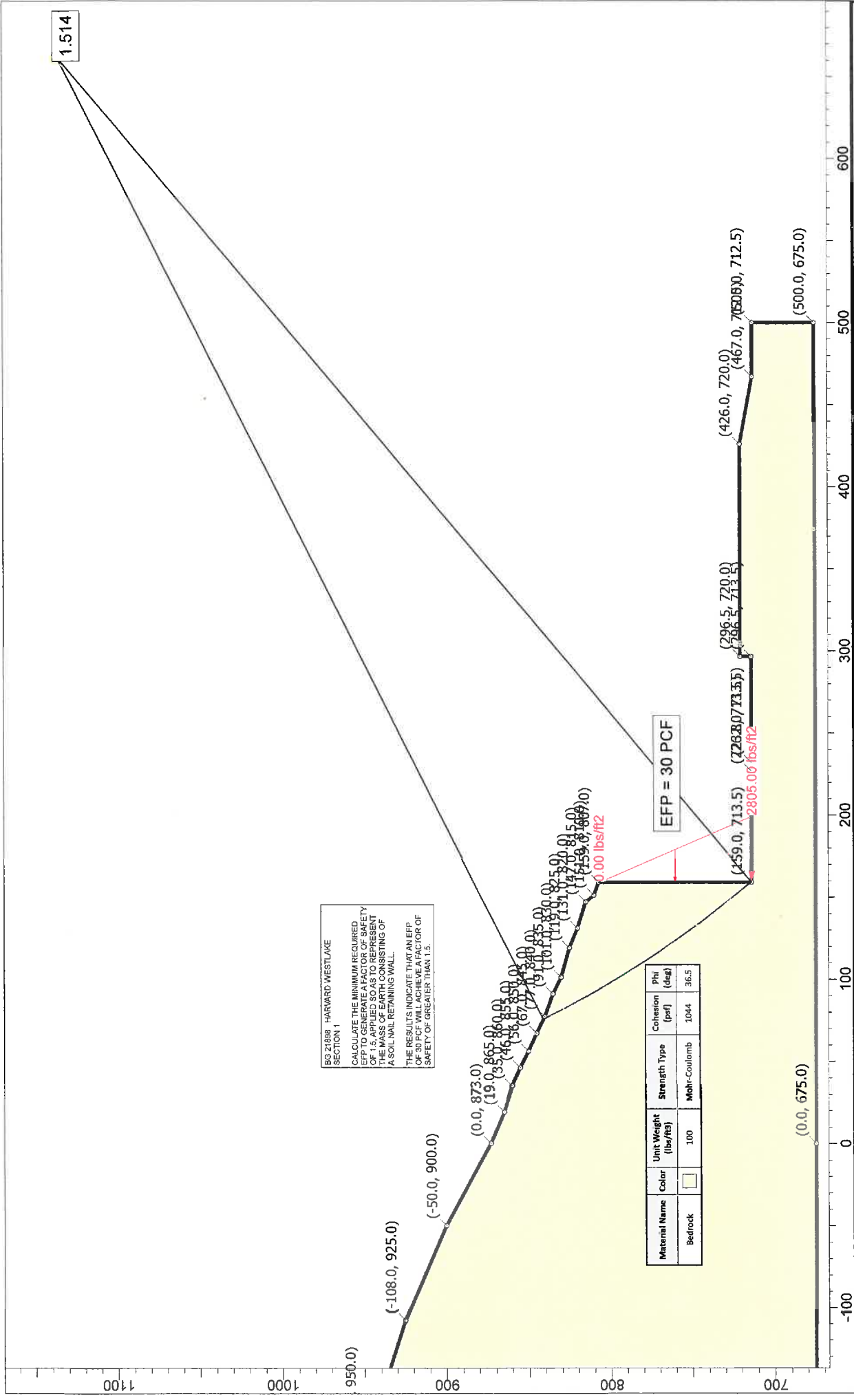

Project

BG 21898 HARVARD-WESTLAKE SECTION 1

Analysis Description

CALCULATE THE MINIMUM REQUIRED EFP TO REPRESENT SOIL NAIL EARTH BLOCK

Drawn By

R. ZWEIGLER

Scale

1:970

Company

BYER GEOTECHNICAL, INC.

Date

5/18/15

File Name 21898 Section 1 efp on back of soil nail wall.slm



Slide Analysis Information

BG 21898 HARVARD-WESTLAKE SECTION 1

Project Summary

File Name: 21898 Section 1 efp on back of soil nail wall
Slide Modeler Version: 6.035
Project Title: BG 21898 HARVARD-WESTLAKE SECTION 1
Analysis: CALCULATE THE GROSS STABILITY THROUGH THE SOIL NAIL WALLS
Author: R. ZWEIGLER
Company: BYER GEOTECHNICAL, INC.
Date Created: 5/18/15

General Settings

Units of Measurement: Imperial Units
Time Units: days
Permeability Units: feet/second
Failure Direction: Left to Right
Data Output: Standard
Maximum Material Properties: 20
Maximum Support Properties: 20

Analysis Options

Analysis Methods Used

Bishop simplified

Number of slices: 25
Tolerance: 0.005
Maximum number of iterations: 50
Check malpha < 0.2: Yes
Initial trial value of FS: 1
Steffensen Iteration: Yes

Groundwater Analysis

Groundwater Method: Water Surfaces
Pore Fluid Unit Weight: 62.4 lbs/ft³
Advanced Groundwater Method: None

Random Numbers

 BYER GEOTECHNICAL INC.	<i>Project</i> BG 21898 HARVARD-WESTLAKE SECTION 1		
	<i>Analysis Description</i> CALCULATE THE GROSS STABILITY THROUGH THE SOIL NAIL WALLS		
	<i>Drawn By</i> R. ZWEIGLER	<i>Scale</i>	<i>Company</i> BYER GEOTECHNICAL, INC.
	<i>Date</i> 5/18/15	<i>File Name</i> 21898 Section 1 efp on back of soil nail wall.slim	

Surface Options

Surface Type: Circular
Search Method: Auto Refine Search
Divisions along slope: 80
Circles per division: 10
Number of iterations: 10
Divisions to use in next iteration: 50%
Composite Surfaces: Disabled
Minimum Elevation: Not Defined
Minimum Depth: Not Defined

Loading

1 Distributed Load present

Distributed Load 1

Distribution: Triangular
Magnitude 1 [psf]: 2805
Magnitude 2 [psf]: 0
Orientation: Horizontal

Material Properties

Property	Bedrock
Color	<input type="checkbox"/>
Strength Type	Mohr-Coulomb
Unit Weight [lbs/ft3]	100
Cohesion [psf]	1044
Friction Angle [deg]	36.5
Water Surface	None
Ru Value	0

Global Minimums

Method: bishop simplified

FS: 1.513780
Center: 662.093, 1135.502
Radius: 656.644
Left Slip Surface Endpoint: 75.260, 840.870

 BYER GEOTECHNICAL INC.	<i>Project</i> BG 21898 HARVARD-WESTLAKE SECTION 1		
	<i>Analysis Description</i> CALCULATE THE GROSS STABILITY THROUGH THE SOIL NAIL WALLS		
	<i>Drawn By</i> R. ZWEIGLER	<i>Scale</i>	<i>Company</i> BYER GEOTECHNICAL, INC.
	<i>Date</i> 5/18/15		<i>File Name</i> 21898 Section 1 efp on back of soil nail wall.slim

SLIDEINTERPRET 6.035

Right Slip Surface Endpoint: 159.000, 713.509
 Left Slope Intercept: 75.260 840.870
 Right Slope Intercept: 159.000 807.000
 Resisting Moment=2.80724e+008 lb-ft
 Driving Moment=1.85445e+008 lb-ft
 Total Slice Area=4444.04 ft2

Valid / Invalid Surfaces

Method: bishop simplified

Number of Valid Surfaces: 214402
 Number of Invalid Surfaces: 0

Slice Data

Global Minimum Query (bishop simplified) - Safety Factor: 1.51378

Slice Number	Width [ft]	Weight [lbs]	Base Material	Base Cohesion [psf]	Base Friction Angle [degrees]	Shear Stress [psf]	Shear Strength [psf]	Base Normal Stress [psf]	Pore Pressure [psf]	Effective Normal Stress [psf]
1	3.34961	839.872	Bedrock	1044	36.5	414.421	627.342	-563.082	0	-563.082
2	3.34961	2591.6	Bedrock	1044	36.5	552.132	835.807	-281.356	0	-281.356
3	3.34961	4307.44	Bedrock	1044	36.5	690.258	1044.9	1.21516	0	1.21516
4	3.34961	5969.2	Bedrock	1044	36.5	827.131	1252.1	281.224	0	281.224
5	3.34961	7572.74	Bedrock	1044	36.5	962.14	1456.47	557.419	0	557.419
6	3.34961	9014.23	Bedrock	1044	36.5	1086.8	1645.18	812.444	0	812.444
7	3.34961	10370.9	Bedrock	1044	36.5	1206.77	1826.78	1057.87	0	1057.87
8	3.34961	11696.7	Bedrock	1044	36.5	1326.11	2007.44	1302.01	0	1302.01
9	3.34961	13159.7	Bedrock	1044	36.5	1458.39	2207.68	1572.62	0	1572.62
10	3.34961	14641.8	Bedrock	1044	36.5	1594.13	2413.16	1850.31	0	1850.31
11	3.34961	16086.4	Bedrock	1044	36.5	1728.61	2616.73	2125.42	0	2125.42
12	3.34961	17495.1	Bedrock	1044	36.5	1861.82	2818.38	2397.95	0	2397.95
13	3.34961	18869.4	Bedrock	1044	36.5	1993.75	3018.1	2667.83	0	2667.83
14	3.34961	20141.7	Bedrock	1044	36.5	2118.52	3206.97	2923.08	0	2923.08
15	3.34961	21295.8	Bedrock	1044	36.5	2234.49	3382.52	3160.33	0	3160.33
16	3.34961	22419.1	Bedrock	1044	36.5	2348.94	3555.78	3394.48	0	3394.48
17	3.34961	23520.7	Bedrock	1044	36.5	2462.58	3727.81	3626.97	0	3626.97
18	3.34961	24679.3	Bedrock	1044	36.5	2582.26	3908.98	3871.8	0	3871.8
19	3.34961	25834.5	Bedrock	1044	36.5	2702.72	4091.33	4118.23	0	4118.23
20	3.34961	26963.4	Bedrock	1044	36.5	2821.89	4271.72	4362	0	4362
21	3.34961	28066.8	Bedrock	1044	36.5	2939.75	4450.14	4603.14	0	4603.14
22	3.34961	28967	Bedrock	1044	36.5	3040.23	4602.24	4808.69	0	4808.69
23	3.34961	29135.5	Bedrock	1044	36.5	3074.95	4654.8	4879.71	0	4879.71
24	3.34961	29913.2	Bedrock	1044	36.5	3165.19	4791.4	5064.33	0	5064.33
25	3.34961	30852.1	Bedrock	1044	36.5	3270.78	4951.24	5280.33	0	5280.33

 BYER GEOTECHNICAL INC.	Project			BG 21898 HARVARD-WESTLAKE SECTION 1						
	Analysis Description						CALCULATE THE GROSS STABILITY THROUGH THE SOIL NAIL WALLS			
	Drawn By	R. ZWEIGLER		Scale	Company			BYER GEOTECHNICAL, INC.		
	Date	5/18/15			File Name	21898 Section 1 efp on back of soil nail wall.slim				

Interslice Data

Global Minimum Query (bishop simplified) - Safety Factor: 1.51378

Slice Number	X coordinate [ft]	Y coordinate - Bottom [ft]	Interslice Normal Force [lbs]	Interslice Shear Force [lbs]	Interslice Force Angle [degrees]
1	75.2599	840.87	0	0	0
2	78.6095	834.291	-5092.43	0	0
3	81.9591	827.889	-8742.72	0	0
4	85.3087	821.653	-11046.8	0	0
5	88.6583	815.574	-12107.2	0	0
6	92.0079	809.643	-12023.2	0	0
7	95.3575	803.852	-10957.6	0	0
8	98.7071	798.193	-9012.83	0	0
9	102.057	792.66	-6250.36	0	0
10	105.406	787.248	-2622.57	0	0
11	108.756	781.95	1841.66	0	0
12	112.106	776.761	7080.33	0	0
13	115.455	771.678	13035.5	0	0
14	118.805	766.695	19652.8	0	0
15	122.154	761.808	26842.2	0	0
16	125.504	757.014	34509.5	0	0
17	128.854	752.309	42613.1	0	0
18	132.203	747.69	51118	0	0
19	135.553	743.155	60031.7	0	0
20	138.902	738.699	69329.9	0	0
21	142.252	734.321	78977.3	0	0
22	145.602	730.017	88940.8	0	0
23	148.951	725.787	99103.3	0	0
24	152.301	721.626	109107	0	0
25	155.65	717.534	119230	0	0
26	159	713.509	131110	0	0

List Of Coordinates

Distributed Load

X	Y
159	713.5
159	807

External Boundary

 BYER GEOTECHNICAL INC.	Project			BG 21898 HARVARD-WESTLAKE SECTION 1		
	Analysis Description					CALCULATE THE GROSS STABILITY THROUGH THE SOIL NAIL WALLS
	Drawn By	R. ZWEIGLER	Scale	Company		BYER GEOTECHNICAL, INC.
	Date	5/18/15		File Name	21898 Section 1 efp on back of soil nail wall.slim	

X	Y
159	713.5
159	807
151	810
147	815
131	820
119	825
101	830
91	835
77	840
67	845
56	850
46	855
35	860
19	865
0	873
-50	900
-108	925
-185	950
-240	957
-240	675
0	675
500	675
500	712.5
467	712.5
426	720
296.5	720
296.5	713.5
232	713.5
226.755	713.5

 BYER GEOTECHNICAL INC.	<i>Project</i> BG 21898 HARVARD-WESTLAKE SECTION 1		
	<i>Analysis Description</i> CALCULATE THE GROSS STABILITY THROUGH THE SOIL NAIL WALLS		
	<i>Drawn By</i> R. ZWEIGLER	<i>Scale</i>	<i>Company</i> BYER GEOTECHNICAL, INC.
	<i>Date</i> 5/18/15	<i>File Name</i> 21898 Section 1 efp on back of soil nail wall.slim	

1.108
0.29

BG 21898 HARVARD WESTLAKE SECTION 1

CALCULATE THE MINIMUM REQUIRED EFP TO GENERATE A FACTOR OF SAFETY OF 1.0 UNDER SEISMIC LOADING. APPLIED SO AS TO REPRESENT THE MASS OF EARTH CONSISTING OF A SOIL NAIL RETAINING WALL. NOTE: THE SEARCH WAS LIMITED TO THE UPSLOPE DISTANCE RESULTING IN THE MOST CRITICAL FAILURE UNDER STATIC CONDITIONS.

THE RESULTS INDICATE THAT AN EFP OF 30 PCF WILL ACHIEVE A FACTOR OF SAFETY OF 1.0 UNDER SEISMIC LOADING.

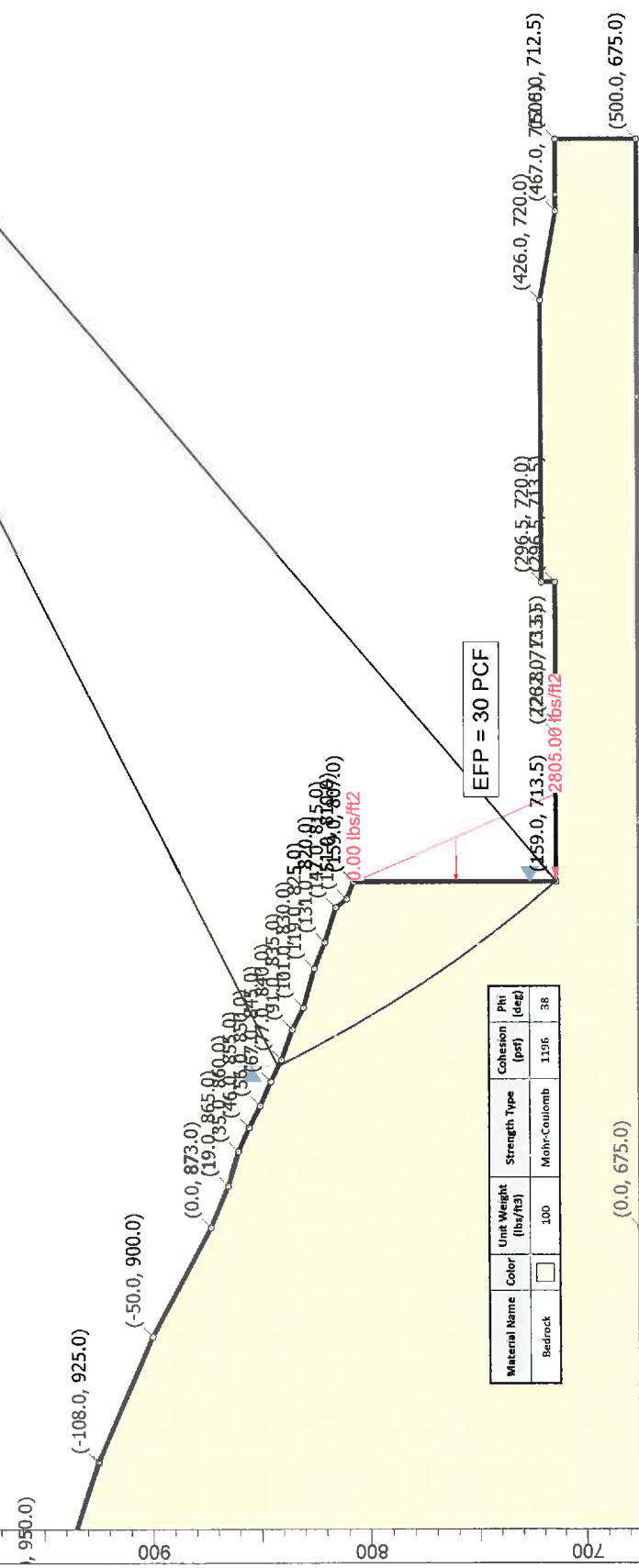

BYER GEOTECHNICAL INC.

Project: BG 21898 HARVARD-WESTLAKE SECTION 1

Analysis Description: CALCULATE THE MINIMUM REQUIRED EFP TO REPRESENT SOIL NAIL EARTH BLOCK (SEISMIC)

Drawn By: R. ZWEIGLER Scale: 1:977 Company: BYER GEOTECHNICAL, INC.

Date: 5/18/15 File Name: 21898 Section 1 efp on back of soil nail wall EQ.slim

SLIDEINTERPRET 6.035

Slide Analysis Information

BG 21898 HARVARD-WESTLAKE SECTION 1

Project Summary

File Name: 21898 Section 1 efp on back of soil nail wall EQ
Slide Modeler Version: 6.035
Project Title: BG 21898 HARVARD-WESTLAKE SECTION 1
Analysis: CALCULATE THE MINIMUM REQUIRED EFP TO REPRESENT SOIL NAIL EARTH BLOCK (SEISMIC)
Author: R. ZWEIGLER
Company: BYER GEOTECHNICAL, INC.
Date Created: 5/18/15

General Settings

Units of Measurement: Imperial Units
Time Units: days
Permeability Units: feet/second
Failure Direction: Left to Right
Data Output: Standard
Maximum Material Properties: 20
Maximum Support Properties: 20

Analysis Options

Analysis Methods Used

Bishop simplified

Number of slices: 25
Tolerance: 0.005
Maximum number of iterations: 50
Check malpha < 0.2: Yes
Initial trial value of FS: 1
Steffensen Iteration: Yes

Groundwater Analysis

Groundwater Method: Water Surfaces
Pore Fluid Unit Weight: 62.4 lbs/ft³
Advanced Groundwater Method: None

Random Numbers

 BYER GEOTECHNICAL INC.	Project			BG 21898 HARVARD-WESTLAKE SECTION 1		
	Analysis Description					
	Drawn By		R. ZWEIGLER	Scale	Company	BYER GEOTECHNICAL, INC.
	Date		5/18/15		File Name	21898 Section 1 efp on back of soil nail wall EQ slim

SLIDEINTERPRET 6.035

Surface Options

Surface Type: Circular
 Search Method: Auto Refine Search
 Divisions along slope: 80
 Circles per division: 10
 Number of iterations: 10
 Divisions to use in next iteration: 50%
 Composite Surfaces: Disabled
 Minimum Elevation: Not Defined
 Minimum Depth: Not Defined

Loading

Seismic Load Coefficient (Horizontal): 0.29
 1 Distributed Load present

Distributed Load 1

Distribution: Triangular
 Magnitude 1 [psf]: 2805
 Magnitude 2 [psf]: 0
 Orientation: Horizontal

Material Properties

Property	Bedrock
Color	<input type="checkbox"/>
Strength Type	Mohr-Coulomb
Unit Weight [lbs/ft ³]	100
Cohesion [psf]	1196
Friction Angle [deg]	38
Water Surface	None
Ru Value	0

Global Minimums

Method: bishop simplified

FS: 1.107660
 Center: 659.756, 1138.512
 Radius: 656.804

 BYER GEOTECHNICAL INC. SLIDEINTERPRET 6.035	Project BG 21898 HARVARD-WESTLAKE SECTION 1		
	Analysis Description CALCULATE THE MINIMUM REQUIRED EFP TO REPRESENT SOIL NAIL EARTH BLOCK (SEISMIC)		
	Drawn By R. ZWEIGLER	Scale	Company BYER GEOTECHNICAL, INC.
	Date 5/18/15	File Name 21898 Section 1 erp on back of soil nail wall EQ slim	

Left Slip Surface Endpoint: 73.925, 841.537
 Right Slip Surface Endpoint: 159.000, 713.500
 Left Slope Intercept: 73.925 841.537
 Right Slope Intercept: 159.000 807.000
 Resisting Moment=2.59078e+008 lb-ft
 Driving Moment=2.33897e+008 lb-ft
 Total Slice Area=4513 ft2

Valid / Invalid Surfaces

Method: bishop simplified

Number of Valid Surfaces: 182255
 Number of Invalid Surfaces: 0

Slice Data

Global Minimum Query (bishop simplified) - Safety Factor: 1.10766

Slice Number	Width [ft]	Weight [lbs]	Base Material	Base Cohesion [psf]	Base Friction Angle [degrees]	Shear Stress [psf]	Shear Strength [psf]	Base Normal Stress [psf]	Pore Pressure [psf]	Effective Normal Stress [psf]
1	3.403	837.6	Bedrock	1196	38	528.809	585.741	-781.096	0	-781.096
2	3.403	2578.76	Bedrock	1196	38	691.868	766.355	-549.92	0	-549.92
3	3.403	4328.53	Bedrock	1196	38	860.11	952.709	-311.398	0	-311.398
4	3.403	6022.88	Bedrock	1196	38	1027.52	1138.14	-74.0572	0	-74.0572
5	3.403	7664.99	Bedrock	1196	38	1194	1322.55	161.973	0	161.973
6	3.403	9177.89	Bedrock	1196	38	1351.98	1497.54	385.95	0	385.95
7	3.403	10558.4	Bedrock	1196	38	1500.56	1662.11	596.598	0	596.598
8	3.403	11894.7	Bedrock	1196	38	1647.66	1825.05	805.146	0	805.146
9	3.403	13328.2	Bedrock	1196	38	1806.82	2001.34	1030.79	0	1030.79
10	3.403	14839.1	Bedrock	1196	38	1976.32	2189.09	1271.1	0	1271.1
11	3.403	16311.4	Bedrock	1196	38	2144.8	2375.71	1509.96	0	1509.96
12	3.403	17746.9	Bedrock	1196	38	2312.22	2561.15	1747.31	0	1747.31
13	3.403	19147.2	Bedrock	1196	38	2478.55	2745.39	1983.13	0	1983.13
14	3.403	20467.9	Bedrock	1196	38	2639.06	2923.18	2210.7	0	2210.7
15	3.403	21645.9	Bedrock	1196	38	2786.91	3086.95	2420.3	0	2420.3
16	3.403	22787.7	Bedrock	1196	38	2932.8	3248.54	2627.14	0	2627.14
17	3.403	23902.5	Bedrock	1196	38	3077.54	3408.87	2832.35	0	2832.35
18	3.403	25069.9	Bedrock	1196	38	3229.52	3577.21	3047.8	0	3047.8
19	3.403	26245.2	Bedrock	1196	38	3384.04	3748.37	3266.88	0	3266.88
20	3.403	27393.4	Bedrock	1196	38	3537.3	3918.13	3484.18	0	3484.18
21	3.403	28515.4	Bedrock	1196	38	3689.31	4086.5	3699.66	0	3699.66
22	3.403	29461.7	Bedrock	1196	38	3823.46	4235.09	3889.86	0	3889.86
23	3.403	29632.3	Bedrock	1196	38	3872.59	4289.51	3959.52	0	3959.52
24	3.403	30394.6	Bedrock	1196	38	3987.85	4417.18	4122.92	0	4122.92

 BYER GEOTECHNICAL INC.	Project			BG 21898 HARVARD-WESTLAKE SECTION 1													
	Analysis Description						CALCULATE THE MINIMUM REQUIRED EFP TO REPRESENT SOIL NAIL EARTH BLOCK (SEISMIC)										
	Drawn By			R. ZWEIGLER			Scale			Company			BYER GEOTECHNICAL, INC.				
	Date						5/18/15						File Name			BG 21898 Section 1 erp on back of soil nail wall EQ slim	

Interslice Data

Global Minimum Query (bishop simplified) - Safety Factor: 1.10766

Slice Number	X coordinate [ft]	Y coordinate - Bottom [ft]	Interslice Normal Force [lbs]	Interslice Shear Force [lbs]	Interslice Force Angle [degrees]
1	73.9251	841.537	0	0	0
2	77.3281	834.918	-6724.74	0	0
3	80.7311	828.477	-11870.1	0	0
4	84.1341	822.203	-15491.2	0	0
5	87.537	816.088	-17689.2	0	0
6	90.94	810.122	-18557.5	0	0
7	94.343	804.297	-18242.1	0	0
8	97.746	798.605	-16884	0	0
9	101.149	793.041	-14553.8	0	0
10	104.552	787.598	-11218.3	0	0
11	107.955	782.271	-6859.59	0	0
12	111.358	777.055	-1540.92	0	0
13	114.761	771.944	4678.43	0	0
14	118.164	766.934	11742.6	0	0
15	121.567	762.022	19569	0	0
16	124.97	757.204	28037.6	0	0
17	128.373	752.476	37101.4	0	0
18	131.776	747.834	46720.8	0	0
19	135.179	743.277	56907	0	0
20	138.582	738.8	67642.9	0	0
21	141.985	734.402	78891.1	0	0
22	145.388	730.079	90615.9	0	0
23	148.791	725.83	102696	0	0
24	152.194	721.652	114673	0	0
25	155.597	717.542	126878	0	0
26	159	713.5	131134	0	0

List Of Coordinates

Distributed Load

X	Y
159	713.5
159	807

 BYER GEOTECHNICAL INC.	Project BG 21898 HARVARD-WESTLAKE SECTION 1		
	Analysis Description CALCULATE THE MINIMUM REQUIRED EFP TO REPRESENT SOIL NAIL EARTH BLOCK (SEISMIC)		
	Drawn By R. ZWEIGLER	Scale	Company BYER GEOTECHNICAL, INC.
	Date 5/18/15	File Name 21898 Section 1 erp on back of soil nail wall EQ slim	
SLIDEINTERPRET 6.035			

External Boundary

X	Y
159	713.5
159	807
151	810
147	815
131	820
119	825
101	830
91	835
77	840
67	845
56	850
46	855
35	860
19	865
0	873
-50	900
-108	925
-185	950
-240	957
-240	675
0	675
500	675
500	712.5
467	712.5
426	720
296.5	720
296.5	713.5
232	713.5
226.755	713.5

 BYER GEOTECHNICAL INC.	<i>Project</i>		
	BG 21898 HARVARD-WESTLAKE SECTION 1		
	<i>Analysis Description</i>		
	CALCULATE THE MINIMUM REQUIRED EFP TO REPRESENT SOIL NAIL EARTH BLOCK (SEISMIC)		
<i>Drawn By</i>	R. ZWEIGLER	<i>Scale</i>	<i>Company</i>
			BYER GEOTECHNICAL, INC.
<i>Date</i>	5/18/15		<i>File Name</i>
			21898 Section 1 etp on back of soil nail wall EQ slim
SLIDEINTERPRET 6.035			

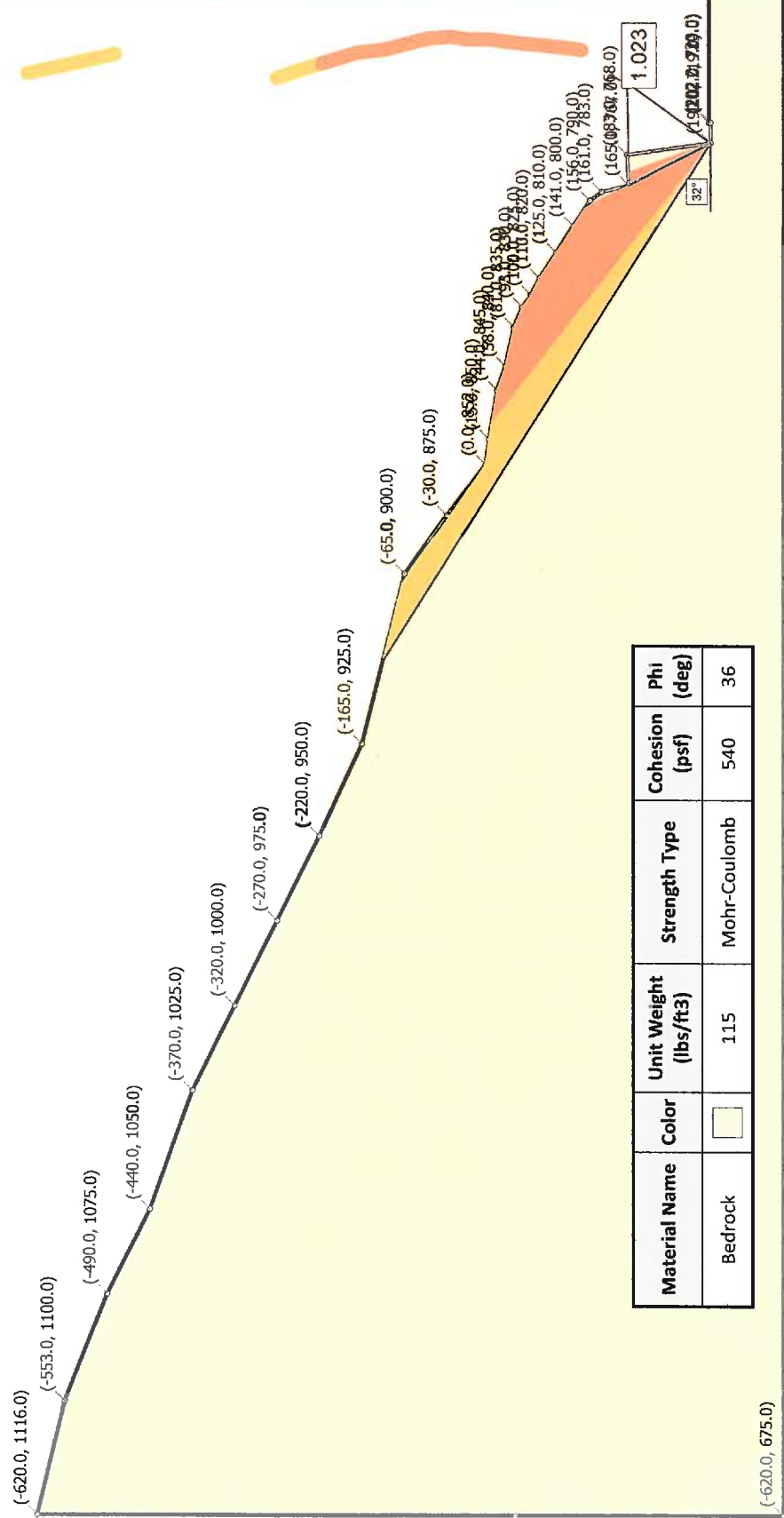
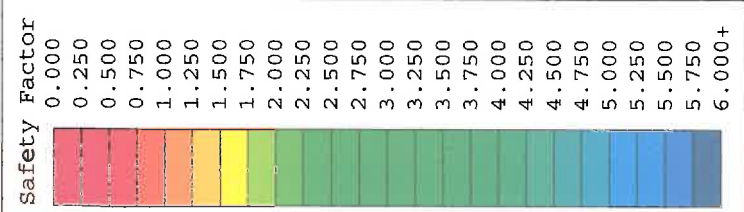

Material Name	Color	Unit Weight (lbs/ft ³)	Strength Type	Cohesion (psf)	Phi (deg)
Bedrock		115	Mohr-Coulomb	540	36

Project: BG 21898 HARVARD-WESTLAKE SECTION 2

Analysis Description: CALCULATE THE LOCATION OF THE 1.5 FACTOR OF SAFETY PLANE

Drawn By: R. ZWEIGLER Scale: 1:1213 Company: BYER GEOTECHNICAL, INC.

Date: 8/1/2014 File Name: 21898 Section 2 ver4.slim

BYER GEOTECHNICAL INC.

SLIDINTERPRET 6.034

Slide Analysis Information

BG 21898 HARVARD-WESTLAKE SECTION 2

Project Summary

File Name: 21898 Section 2 ver4
Slide Modeler Version: 6.034
Project Title: BG 21898 HARVARD-WESTLAKE SECTION 2
Analysis: CALCULATE THE LOCATION OF THE 1.5 FACTOR OF SAFETY PLANE
Author: R. ZWEIGLER
Company: BYER GEOTECHNICAL, INC.
Date Created: 8/1/2014

General Settings

Units of Measurement: Imperial Units
Time Units: days
Permeability Units: feet/second
Failure Direction: Left to Right
Data Output: Standard
Maximum Material Properties: 20
Maximum Support Properties: 20

Analysis Options

Analysis Methods Used

Janbu corrected

Number of slices: 25
Tolerance: 0.005
Maximum number of iterations: 50
Check malpha < 0.2: Yes
Initial trial value of FS: 1
Steffensen Iteration: Yes

Groundwater Analysis

Groundwater Method: Water Surfaces
Pore Fluid Unit Weight: 62.4 lbs/ft³
Advanced Groundwater Method: None

 BYER GEOTECHNICAL INC.	<i>Project</i>			BG 21898 HARVARD-WESTLAKE SECTION 2	
	<i>Analysis Description</i>			CALCULATE THE LOCATION OF THE 1.5 FACTOR OF SAFETY PLANE	
	<i>Drawn By</i>	R. ZWEIGLER	<i>Scale</i>	<i>Company</i>	BYER GEOTECHNICAL, INC.
	<i>Date</i>	8/1/2014	<i>File Name</i>	21898 Section 2 ver4.slim	

Random Numbers

Pseudo-random Seed: 10116

Random Number Generation Method: Park and Miller v.3

Surface Options

Surface Type: Non-Circular Block Search

Number of Surfaces: 5000

Pseudo-Random Surfaces: Enabled

Convex Surfaces Only: Disabled

Left Projection Angle (Start Angle): 95

Left Projection Angle (End Angle): 220

Right Projection Angle (Start Angle): -85

Right Projection Angle (End Angle): 85

Minimum Elevation: Not Defined

Minimum Depth: Not Defined

Material Properties

Property	Bedrock
Color	<input type="checkbox"/>
Strength Type	Mohr-Coulomb
Unit Weight [lbs/ft ³]	115
Cohesion [psf]	540
Friction Angle [deg]	36
Water Surface	None
Ru Value	0

Global Minimums

Method: janbu corrected

FS: 1.022800

Axis Location: 225.518, 767.969

Left Slip Surface Endpoint: 165.032, 767.002

Right Slip Surface Endpoint: 190.000, 719.000

Resisting Horizontal Force=21383.6 lb

Driving Horizontal Force=20906.9 lb

Total Slice Area=443.709 ft²

Global Minimum Coordinates

 BYER GEOTECHNICAL INC.	Project			BG 21898 HARVARD-WESTLAKE SECTION 2	
	Analysis Description			CALCULATE THE LOCATION OF THE 1.5 FACTOR OF SAFETY PLANE	
	Drawn By	R. ZWEIGLER	Scale	Company	BYER GEOTECHNICAL, INC.
	Date	8/1/2014		File Name	21898 Section 2 ver4.slim

Method: janbu corrected

X	Y
165.032	767.002
190	719

Valid / Invalid Surfaces

Method: janbu corrected

Number of Valid Surfaces: 4069
 Number of Invalid Surfaces: 931

Error Codes:

Error Code -105 reported for 436 surfaces
 Error Code -108 reported for 495 surfaces

Error Codes

The following errors were encountered during the computation:

- 105 = More than two surface / slope intersections with no valid slip surface.
- 108 = Total driving moment or total driving force < 0.1. This is to limit the calculation of extremely high safety factors if the driving force is very small (0.1 is an arbitrary number).

Slice Data

Global Minimum Query (janbu corrected) - Safety Factor: 1.0228

Slice Number	Width [ft]	Weight [lbs]	Base Material	Base Cohesion [psf]	Base Friction Angle [degrees]	Shear Stress [psf]	Shear Strength [psf]	Base Normal Stress [psf]	Pore Pressure [psf]	Effective Normal Stress [psf]
1	0.998719	113.449	Bedrock	540	36	257.443	263.313	-380.827	0	-380.827
2	0.998719	340.347	Bedrock	540	36	325.703	333.129	-284.733	0	-284.733
3	0.998719	567.245	Bedrock	540	36	393.964	402.946	-188.639	0	-188.639
4	0.998719	794.143	Bedrock	540	36	462.224	472.763	-92.5443	0	-92.5443
5	0.998719	1021.04	Bedrock	540	36	530.484	542.579	3.55019	0	3.55019
6	0.998719	1247.94	Bedrock	540	36	598.745	612.396	99.6446	0	99.6446
7	0.998719	1474.84	Bedrock	540	36	667.005	682.213	195.739	0	195.739
8	0.998719	1701.73	Bedrock	540	36	735.265	752.029	291.833	0	291.833
9	0.998719	1928.63	Bedrock	540	36	803.526	821.846	387.928	0	387.928
10	0.998719	2155.53	Bedrock	540	36	871.786	891.663	484.022	0	484.022
11	0.998719	2382.43	Bedrock	540	36	940.046	961.479	580.119	0	580.119

 <p>BYER GEOTECHNICAL INC.</p>	Project			BG 21898 HARVARD-WESTLAKE SECTION 2		
	Analysis Description			CALCULATE THE LOCATION OF THE 1.5 FACTOR OF SAFETY PLANE		
	Drawn By	R. ZWEIGLER	Scale	Company	BYER GEOTECHNICAL, INC.	
	Date	8/1/2014		File Name	21898 Section 2 ver4.slim	

12	0.998719	2609.33	Bedrock	540	36	1008.31	1031.3	676.211	0	676.211
13	0.998719	2836.22	Bedrock	540	36	1076.57	1101.11	772.307	0	772.307
14	0.998719	3063.12	Bedrock	540	36	1144.83	1170.93	868.399	0	868.399
15	0.998719	3290.02	Bedrock	540	36	1213.09	1240.75	964.496	0	964.496
16	0.998719	3516.92	Bedrock	540	36	1281.35	1310.56	1060.59	0	1060.59
17	0.998719	3743.82	Bedrock	540	36	1349.61	1380.38	1156.68	0	1156.68
18	0.998719	3970.68	Bedrock	540	36	1417.86	1450.19	1252.76	0	1252.76
19	0.998719	3785.69	Bedrock	540	36	1362.21	1393.26	1174.42	0	1174.42
20	0.998719	3203.28	Bedrock	540	36	1186.99	1214.05	927.758	0	927.758
21	0.998719	2620.86	Bedrock	540	36	1011.78	1034.85	681.094	0	681.094
22	0.998719	2038.45	Bedrock	540	36	836.563	855.637	434.437	0	434.437
23	0.998719	1456.04	Bedrock	540	36	661.348	676.427	187.776	0	187.776
24	0.998719	873.621	Bedrock	540	36	486.134	497.218	-58.8842	0	-58.8842
25	0.998719	291.207	Bedrock	540	36	310.92	318.009	-305.544	0	-305.544

Interslice Data

Global Minimum Query (janbu corrected) - Safety Factor: 1.0228

Slice Number	X coordinate [ft]	Y coordinate - Bottom [ft]	Interslice Normal Force [lbs]	Interslice Shear Force [lbs]	Interslice Force Angle [degrees]
1	165.032	767.002	0	0	0
2	166.031	765.082	-988.058	0	0
3	167.029	763.162	-1859.71	0	0
4	168.028	761.242	-2614.95	0	0
5	169.027	759.321	-3253.79	0	0
6	170.026	757.401	-3776.22	0	0
7	171.024	755.481	-4182.24	0	0
8	172.023	753.561	-4471.86	0	0
9	173.022	751.641	-4645.07	0	0
10	174.02	749.721	-4701.87	0	0
11	175.019	747.801	-4642.27	0	0
12	176.018	745.881	-4466.26	0	0
13	177.017	743.961	-4173.84	0	0
14	178.015	742.041	-3765.02	0	0
15	179.014	740.121	-3239.78	0	0
16	180.013	738.201	-2598.15	0	0
17	181.012	736.281	-1840.1	0	0
18	182.01	734.361	-965.647	0	0
19	183.009	732.44	25.1959	0	0
20	184.008	730.52	921.132	0	0
21	185.006	728.6	1518.27	0	0

 BYER GEOTECHNICAL INC.	Project			BG 21898 HARVARD-WESTLAKE SECTION 2		
	Analysis Description			CALCULATE THE LOCATION OF THE 1.5 FACTOR OF SAFETY PLANE		
	Drawn By	R. ZWEIGLER	Scale	Company	BYER GEOTECHNICAL, INC.	
	Date	8/1/2014		File Name	21898 Section 2 ver4.slim	

22	186.005	726.68	1816.61	0	0
23	187.004	724.76	1816.14	0	0
24	188.003	722.84	1516.88	0	0
25	189.001	720.92	918.818	0	0
26	190	719	0	0	0

List Of Coordinates

External Boundary

X	Y
156	790
141	800
125	810
110	820
100	825
93	830
81	835
58	840
44	845
15	850
0	852
-30	875
-65	900
-165	925
-220	950
-270	975
-320	1000
-370	1025
-440	1050
-490	1075
-553	1100
-620	1116
-620	675
430	675
430	720
202	720
202	719
190	719
183	768
165	767
161	783

 BYER GEOTECHNICAL INC.	<i>Project</i> BG 21898 HARVARD-WESTLAKE SECTION 2			
	<i>Analysis Description</i> CALCULATE THE LOCATION OF THE 1.5 FACTOR OF SAFETY PLANE			
	<i>Drawn By</i> R. ZWEIGLER	<i>Scale</i>	<i>Company</i> BYER GEOTECHNICAL, INC.	
	<i>Date</i> 8/1/2014		<i>File Name</i> 21898 Section 2 ver4.slim	



BYER
GEOTECHNICAL
INC.

SLIDEINTERPRET 6.034

Project

BG 21898 HARVARD-WESTLAKE SECTION 2

Analysis Description

CALCULATE THE LOCATION OF THE 1.5 FACTOR OF SAFETY PLANE

Drawn By

R. ZWEIGLER

Scale

Company

BYER GEOTECHNICAL, INC.

Date

8/1/2014

File Name

21898 Section 2 ver4.slim

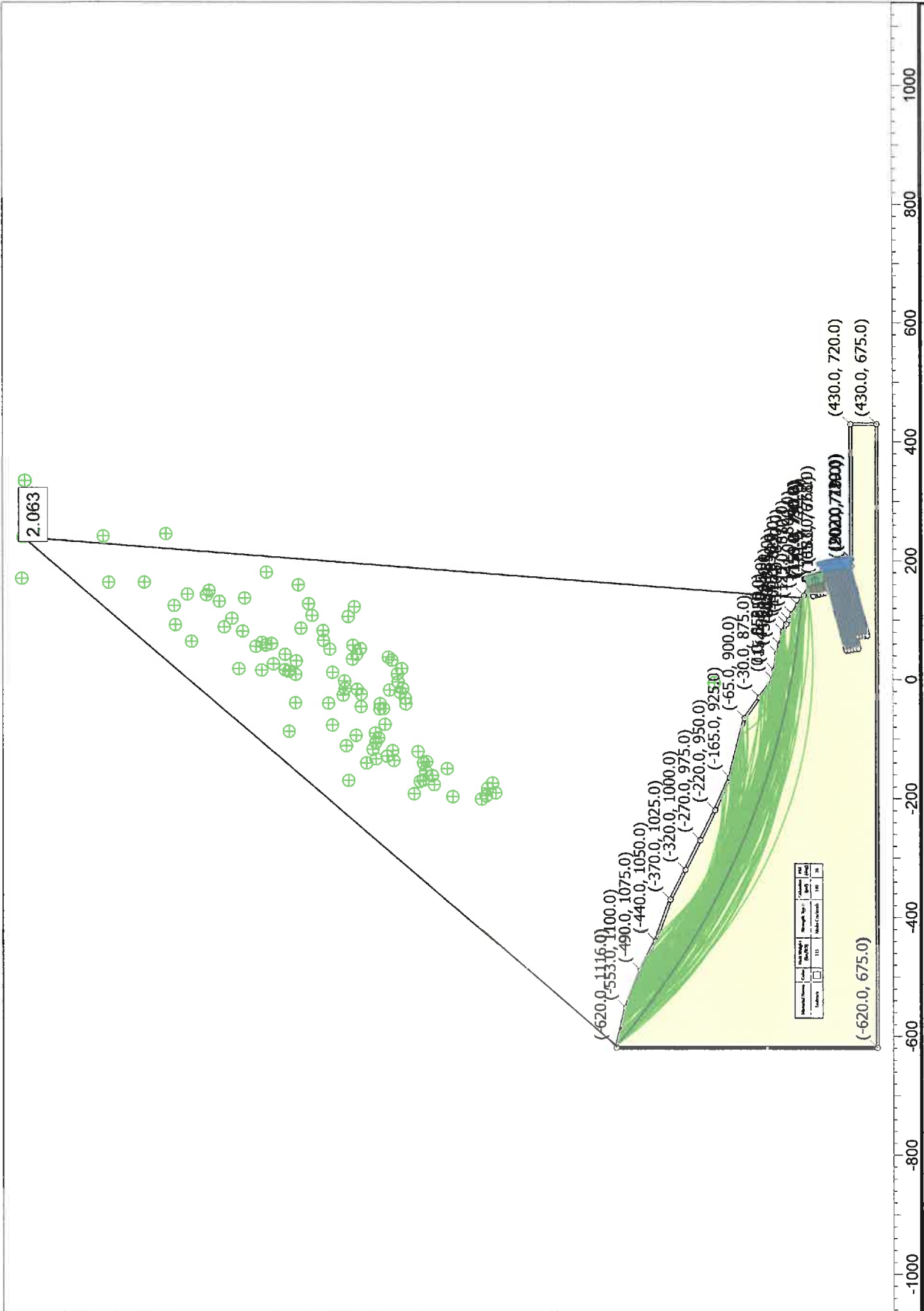
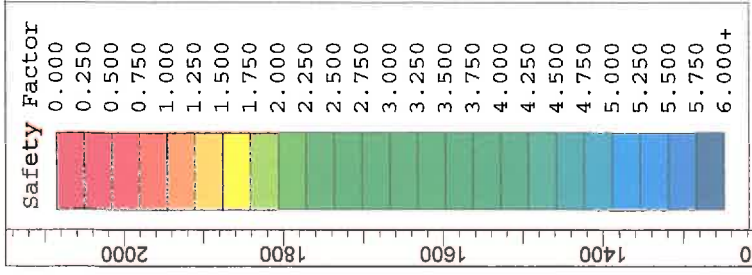

Project		BG 21898 HARVARD-WESTLAKE SECTION 2	
Analysis Description		CALCULATE THE GROSS STABILITY OF FAILURES ABOVE SOIL NAIL WALLS	
Drawn By	R. ZWEIGLER	Scale	1:2900
Company		BYER GEOTECHNICAL, INC.	
Date	4/10/15	File Name	21898 Section 2 Above soil nails updated.slm



Slide Analysis Information

BG 21898 HARVARD-WESTLAKE SECTION 2

Project Summary

File Name: 21898 Section 2 Above soil nails updated
Slide Modeler Version: 6.034
Project Title: BG 21898 HARVARD-WESTLAKE SECTION 2
Analysis: CALCULATE THE GROSS STABILITY OF FAILURES ABOVE SOIL NAIL WALLS
Author: R. ZWEIGLER
Company: BYER GEOTECHNICAL, INC.
Date Created: 4/10/15

General Settings

Units of Measurement: Imperial Units
Time Units: days
Permeability Units: feet/second
Failure Direction: Left to Right
Data Output: Standard
Maximum Material Properties: 20
Maximum Support Properties: 20

Analysis Options

Analysis Methods Used

Bishop simplified

Number of slices: 25
Tolerance: 0.005
Maximum number of iterations: 50
Check $m\alpha < 0.2$: Yes
Initial trial value of FS: 1
Steffensen Iteration: Yes

Groundwater Analysis

Groundwater Method: Water Surfaces
Pore Fluid Unit Weight: 62.4 lbs/ft³
Advanced Groundwater Method: None

 BYER GEOTECHNICAL INC.	<i>Project</i> BG 21898 HARVARD-WESTLAKE SECTION 2		
	<i>Analysis Description</i> CALCULATE THE GROSS STABILITY OF FAILURES ABOVE SOIL NAIL WALLS		
	<i>Drawn By</i> R. ZWEIGLER	<i>Scale</i>	<i>Company</i> BYER GEOTECHNICAL, INC.
	<i>Date</i> 4/10/15	<i>File Name</i> 21898 Section 2 Above soil nails updated.slim	

Random Numbers

Pseudo-random Seed: 10116

Random Number Generation Method: Park and Miller v.3

Surface Options

Surface Type: Circular

Search Method: Slope Search

Number of Surfaces: 5000

Upper Angle: Not Defined

Lower Angle: Not Defined

Composite Surfaces: Disabled

Reverse Curvature: Create Tension Crack

Minimum Elevation: Not Defined

Minimum Depth: Not Defined

Material Properties

Property	Bedrock
Color	<input type="checkbox"/>
Strength Type	Mohr-Coulomb
Unit Weight [lbs/ft ³]	115
Cohesion [psf]	540
Friction Angle [deg]	36
Water Surface	None
Ru Value	0

Support Properties

Soil Nail

Support Type: Soil Nail

Force Application: Passive

Out-of-Plane Spacing: 5 ft

Tensile Capacity: 93750 lb

Plate Capacity: 37100 lb

Bond Strength: 2413 lb/ft

Support 2

Support Type: Soil Nail

 BYER GEOTECHNICAL INC.	<i>Project</i> BG 21898 HARVARD-WESTLAKE SECTION 2		
	<i>Analysis Description</i> CALCULATE THE GROSS STABILITY OF FAILURES ABOVE SOIL NAIL WALLS		
	<i>Drawn By</i> R. ZWEIGLER	<i>Scale</i>	<i>Company</i> BYER GEOTECHNICAL, INC.
	<i>Date</i> 4/10/15		<i>File Name</i> 21898 Section 2 Above soil nails updated.slim

Force Application: Passive
 Out-of-Plane Spacing: 5 ft
 Tensile Capacity: 25000 lb
 Plate Capacity: 37100 lb
 Bond Strength: 1810 lb/ft

Global Minimums

Method: bishop simplified

FS: 2.062910
 Center: 239.025, 2113.538
 Radius: 1315.005
 Left Slip Surface Endpoint: -616.958, 1115.273
 Right Slip Surface Endpoint: 137.006, 802.496
 Resisting Moment=4.69192e+009 lb-ft
 Driving Moment=2.27442e+009 lb-ft
 Total Slice Area=39814.8 ft2

Valid / Invalid Surfaces

Method: bishop simplified

Number of Valid Surfaces: 4953
 Number of Invalid Surfaces: 47

Error Codes:

Error Code -101 reported for 1 surface
 Error Code -103 reported for 5 surfaces
 Error Code -106 reported for 38 surfaces
 Error Code -108 reported for 3 surfaces

Error Codes

The following errors were encountered during the computation:

- 101 = Only one (or zero) surface / slope intersections.
- 103 = Two surface / slope intersections, but one or more surface / nonslope external polygon intersections lie between them. This usually occurs when the slip surface extends past the bottom of the soil region, but may also occur on a benched slope model with two sets of Slope Limits.
- 106 = Average slice width is less than 0.0001 * (maximum horizontal extent of soil region). This limitation is imposed to avoid numerical errors which may result from too many slices, or too small a slip region.
- 108 = Total driving moment or total driving force < 0.1. This is to limit the calculation of extremely high safety factors if the driving force is very small (0.1 is an arbitrary number).

Slice Data

 BYER GEOTECHNICAL INC.	<i>Project</i> BG 21898 HARVARD-WESTLAKE SECTION 2		
	<i>Analysis Description</i> CALCULATE THE GROSS STABILITY OF FAILURES ABOVE SOIL NAIL WALLS		
	<i>Drawn By</i> R. ZWEIGLER	<i>Scale</i>	<i>Company</i> BYER GEOTECHNICAL, INC.
	<i>Date</i> 4/10/15	<i>File Name</i> Z1898 Section 2 Above soil nails updated.slim	

Global Minimum Query (bishop simplified) - Safety Factor: 2.06291

Slice Number	Width [ft]	Weight [lbs]	Base Material	Base Cohesion [psf]	Base Friction Angle [degrees]	Shear Stress [psf]	Shear Strength [psf]	Base Normal Stress [psf]	Pore Pressure [psf]	Effective Normal Stress [psf]
1	30.1585	31018.5	Bedrock	540	36	482.812	995.998	627.629	0	627.629
2	30.1585	90508.1	Bedrock	540	36	1034.04	2133.14	2192.76	0	2192.76
3	30.1585	138683	Bedrock	540	36	1493.9	3081.79	3498.47	0	3498.47
4	30.1585	172227	Bedrock	540	36	1826.74	3768.41	4443.51	0	4443.51
5	30.1585	197942	Bedrock	540	36	2091.88	4315.36	5196.34	0	5196.34
6	30.1585	212501	Bedrock	540	36	2254.68	4651.2	5658.6	0	5658.6
7	30.1585	232117	Bedrock	540	36	2468.84	5093	6266.65	0	6266.65
8	30.1585	253645	Bedrock	540	36	2705.03	5580.23	6937.27	0	6937.27
9	30.1585	266705	Bedrock	540	36	2861.02	5902.03	7380.2	0	7380.2
10	30.1585	266600	Bedrock	540	36	2887.44	5956.53	7455.22	0	7455.22
11	30.1585	262951	Bedrock	540	36	2877.61	5936.25	7427.29	0	7427.29
12	30.1585	256137	Bedrock	540	36	2834.49	5847.29	7304.86	0	7304.86
13	30.1585	246261	Bedrock	540	36	2758.34	5690.2	7088.66	0	7088.66
14	30.1585	235080	Bedrock	540	36	2666.63	5501.02	6828.27	0	6828.27
15	30.1585	224035	Bedrock	540	36	2574.13	5310.19	6565.61	0	6565.61
16	30.1585	221227	Bedrock	540	36	2566.26	5293.97	6543.29	0	6543.29
17	30.1585	226067	Bedrock	540	36	2639.02	5444.06	6749.85	0	6749.85
18	30.1585	228213	Bedrock	540	36	2683.68	5536.2	6876.66	0	6876.66
19	30.1585	215881	Bedrock	540	36	2572.39	5306.61	6560.68	0	6560.68
20	30.1585	165644	Bedrock	540	36	2046.46	4221.67	5067.39	0	5067.39
21	30.1585	116292	Bedrock	540	36	1521.52	3138.76	3576.88	0	3576.88
22	30.1585	111105	Bedrock	540	36	1476.3	3045.47	3448.49	0	3448.49
23	30.1585	100146	Bedrock	540	36	1365.9	2817.72	3135.02	0	3135.02
24	30.1585	79007	Bedrock	540	36	1139.28	2350.23	2491.57	0	2491.57
25	30.1585	28704.8	Bedrock	540	36	578.792	1193.99	900.147	0	900.147

Interslice Data

Global Minimum Query (bishop simplified) - Safety Factor: 2.06291

Slice Number	X coordinate [ft]	Y coordinate - Bottom [ft]	Interslice Normal Force [lbs]	Interslice Shear Force [lbs]	Interslice Force Angle [degrees]
1	-616.958	1115.27	0	0	0
2	-586.799	1090.18	1213.74	0	0
3	-556.64	1066.56	21882.2	0	0
4	-526.482	1044.32	54751.3	0	0
5	-496.323	1023.35	92906.4	0	0

 <p>BYER GEOTECHNICAL INC.</p>	Project		BG 21898 HARVARD-WESTLAKE SECTION 2		
	Analysis Description		CALCULATE THE GROSS STABILITY OF FAILURES ABOVE SOIL NAIL WALLS		
	Drawn By	R. ZWEIGLER	Scale	Company	BYER GEOTECHNICAL, INC.
	Date	4/10/15	File Name	21898 Section 2 Above soil nails updated.slim	

6	-466.165	1003.61	132549	0	0
7	-436.006	985.012	169906	0	0
8	-405.848	967.511	205264	0	0
9	-375.689	951.056	237996	0	0
10	-345.531	935.602	265930	0	0
11	-315.372	921.111	287050	0	0
12	-285.214	907.548	301170	0	0
13	-255.055	894.882	308375	0	0
14	-224.896	883.085	308971	0	0
15	-194.738	872.132	303490	0	0
16	-164.579	862.002	292517	0	0
17	-134.421	852.675	276304	0	0
18	-104.262	844.132	254531	0	0
19	-74.1037	836.358	227208	0	0
20	-43.9452	829.339	195825	0	0
21	-13.7866	823.063	166027	0	0
22	16.3719	817.519	140059	0	0
23	46.5305	812.698	112247	0	0
24	76.689	808.591	84007.3	0	0
25	106.848	805.193	58182.7	0	0
26	137.006	802.496	0	0	0

List Of Coordinates

External Boundary

X	Y
156	790
141	800
125	810
110	820
100	825
93	830
81	835
58	840
44	845
15	850
0	852
-30	875
-65	900
-165	925
-220	950

 <p>BYER GEOTECHNICAL INC.</p>	Project			BG 21898 HARVARD-WESTLAKE SECTION 2	
	Analysis Description			CALCULATE THE GROSS STABILITY OF FAILURES ABOVE SOIL NAIL WALLS	
	Drawn By	R. ZWEIGLER	Scale	Company	BYER GEOTECHNICAL, INC.
	Date	4/10/15		File Name	21898 Section 2 Above soil nails updated.slim

-270	975
-320	1000
-370	1025
-440	1050
-490	1075
-553	1100
-620	1116
-620	675
430	675
430	720
202	720
202	719
190	719
183	768
165	767
161	783
159	790

 BYER GEOTECHNICAL INC.	<i>Project</i>			BG 21898 HARVARD-WESTLAKE SECTION 2	
	<i>Analysis Description</i>			CALCULATE THE GROSS STABILITY OF FAILURES ABOVE SOIL NAIL WALLS	
	<i>Drawn By</i>	R. ZWEIGLER	<i>Scale</i>	<i>Company</i>	BYER GEOTECHNICAL, INC.
	<i>Date</i>	4/10/15		<i>File Name</i>	21898 Section 2 Above soil nails updated.slim

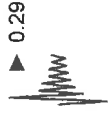
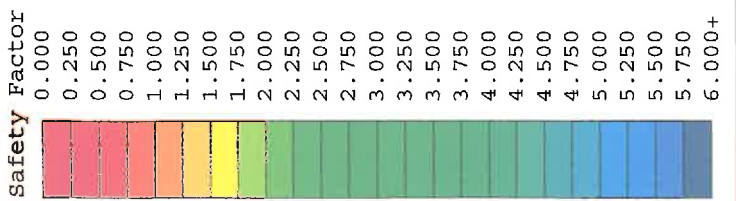

1.218

BG 21898 HARVARD-WESTLAKE SECTION 2
 CALCULATE THE SEISMIC STABILITY OF FAILURES ABOVE THE PROPOSED SOIL NAIL RETAINING WALLS. SHOW THE 100 MOST CRITICAL CIRCLES.
 THE FACTOR OF SAFETY EXCEEDS 1.0.

Material Name	Color	Unit Weight (pcf)	Strength Type	cohesion (ksf)	phi (deg)
Backfill		122	Non-Cohesive	0.00	31



BYER GEOTECHNICAL INC.		Project	BG 21898 HARVARD-WESTLAKE SECTION 2		
		Analysis Description	CALCULATE THE SEISMIC STABILITY OF FAILURES ABOVE SOIL NAIL WALLS		
		Drawn By	Scale	Company	BYER GEOTECHNICAL, INC.
		Date	1:2426	File Name	21898 Section 2 Above soil nails EQ updated.slim
			4/10/15		

Slide Analysis Information

BG 21898 HARVARD-WESTLAKE SECTION 2

Project Summary

File Name: 21898 Section 2 Above soil nails EQ updated
Slide Modeler Version: 6.035
Project Title: BG 21898 HARVARD-WESTLAKE SECTION 2
Analysis: CALCULATE THE SEISMIC STABILITY OF FAILURES ABOVE SOIL NAIL WALLS
Author: R. ZWEIGLER
Company: BYER GEOTECHNICAL, INC.
Date Created: 4/10/15

General Settings

Units of Measurement: Imperial Units
Time Units: days
Permeability Units: feet/second
Failure Direction: Left to Right
Data Output: Standard
Maximum Material Properties: 20
Maximum Support Properties: 20

Analysis Options

Analysis Methods Used

Bishop simplified

Number of slices: 25
Tolerance: 0.005
Maximum number of iterations: 50
Check malpha < 0.2: Yes
Initial trial value of FS: 1
Steffensen Iteration: Yes

Groundwater Analysis

Groundwater Method: Water Surfaces
Pore Fluid Unit Weight: 62.4 lbs/ft³
Advanced Groundwater Method: None

Random Numbers

 BYER GEOTECHNICAL INC. <small>SLIDEINTERPRET 6.035</small>	<i>Project</i> BG 21898 HARVARD-WESTLAKE SECTION 2		
	<i>Analysis Description</i> CALCULATE THE SEISMIC STABILITY OF FAILURES ABOVE SOIL NAIL WALLS		
	<i>Drawn By</i> R. ZWEIGLER	<i>Scale</i>	<i>Company</i> BYER GEOTECHNICAL, INC.
	<i>Date</i> 4/10/15	<i>File Name</i> 21898 Section 2 Above soil nails EQ updated.slim	

Surface Options

Surface Type: Circular
Search Method: Slope Search
Number of Surfaces: 5000
Upper Angle: Not Defined
Lower Angle: Not Defined
Composite Surfaces: Disabled
Reverse Curvature: Create Tension Crack
Minimum Elevation: Not Defined
Minimum Depth: Not Defined

Loading

Seismic Load Coefficient (Horizontal): 0.29

Material Properties

Property	Bedrock
Color	<input type="checkbox"/>
Strength Type	Mohr-Coulomb
Unit Weight [lbs/ft ³]	115
Cohesion [psf]	825
Friction Angle [deg]	37
Water Surface	None
Ru Value	0

Support Properties

Soil Nail

Support Type: Soil Nail
Force Application: Passive
Out-of-Plane Spacing: 5 ft
Tensile Capacity: 125000 lb
Plate Capacity: 37100 lb
Bond Strength: 3217 lb/ft

Support 2

Support Type: Soil Nail
Force Application: Passive

 BYER GEOTECHNICAL INC.	<i>Project</i> BG 21898 HARVARD-WESTLAKE SECTION 2		
	<i>Analysis Description</i> CALCULATE THE SEISMIC STABILITY OF FAILURES ABOVE SOIL NAIL WALLS		
	<i>Drawn By</i> R. ZWEIGLER	<i>Scale</i>	<i>Company</i> BYER GEOTECHNICAL, INC.
	<i>Date</i> 4/10/15	<i>File Name</i> 21898 Section 2 Above soil nails EQ updated.slim	

SLIDEINTERPRET 6.035

Out-of-Plane Spacing: 5 ft
 Tensile Capacity: 33333 lb
 Plate Capacity: 37100 lb
 Bond Strength: 2413 lb/ft

Global Minimums

Method: bishop simplified

FS: 1.218030
 Center: 143.105, 1837.045
 Radius: 1035.979
 Left Slip Surface Endpoint: -594.914, 1110.009
 Right Slip Surface Endpoint: 139.283, 801.073
 Resisting Moment=4.1505e+009 lb-ft
 Driving Moment=3.40755e+009 lb-ft
 Total Slice Area=45607 ft²

Valid / Invalid Surfaces

Method: bishop simplified

Number of Valid Surfaces: 4953
 Number of Invalid Surfaces: 47

Error Codes:

Error Code -101 reported for 1 surface
 Error Code -103 reported for 5 surfaces
 Error Code -106 reported for 38 surfaces
 Error Code -108 reported for 3 surfaces

Error Codes

The following errors were encountered during the computation:

- 101 = Only one (or zero) surface / slope intersections.
- 103 = Two surface / slope intersections, but one or more surface / nonslope external polygon intersections lie between them. This usually occurs when the slip surface extends past the bottom of the soil region, but may also occur on a benched slope model with two sets of Slope Limits.
- 106 = Average slice width is less than 0.0001 * (maximum horizontal extent of soil region). This limitation is imposed to avoid numerical errors which may result from too many slices, or too small a slip region.
- 108 = Total driving moment or total driving force < 0.1. This is to limit the calculation of extremely high safety factors if the driving force is very small (0.1 is an arbitrary number).

Slice Data

Global Minimum Query (bishop simplified) - Safety Factor: 1.21803

	Base	Base	Shear	Shear	Base	Pore	Effective
 BYER GEOTECHNICAL INC.	<i>Project</i> BG 21898 HARVARD-WESTLAKE SECTION 2						
	<i>Analysis Description</i> CALCULATE THE SEISMIC STABILITY OF FAILURES ABOVE SOIL NAIL WALLS						
	<i>Drawn By</i> R. ZWEIGLER		<i>Scale</i>		<i>Company</i> BYER GEOTECHNICAL, INC.		
	<i>Date</i> 4/10/15		<i>File Name</i> 21898 Section 2 Above soil nails EQ updated.slim				

Number	[ft]	[lbs]	Material	Cohesion [psf]	Friction Angle [degrees]	Stress [psf]	Strength [psf]	Normal Stress [psf]	Pressure [psf]	Normal Stress [psf]
1	29.3679	36543.4	Bedrock	825	37	902.889	1099.75	364.601	0	364.601
2	29.3679	103430	Bedrock	825	37	1833.72	2233.53	1869.19	0	1869.19
3	29.3679	151743	Bedrock	825	37	2553.99	3110.84	3033.42	0	3033.42
4	29.3679	191438	Bedrock	825	37	3183.22	3877.26	4050.49	0	4050.49
5	29.3679	217789	Bedrock	825	37	3642.45	4436.61	4792.77	0	4792.77
6	29.3679	240905	Bedrock	825	37	4068.43	4955.47	5481.31	0	5481.31
7	29.3679	269017	Bedrock	825	37	4583.09	5582.34	6313.2	0	6313.2
8	29.3679	292237	Bedrock	825	37	5037.49	6135.81	7047.67	0	7047.67
9	29.3679	300852	Bedrock	825	37	5273.24	6422.97	7428.75	0	7428.75
10	29.3679	302289	Bedrock	825	37	5397.08	6573.8	7628.92	0	7628.92
11	29.3679	299818	Bedrock	825	37	5456.56	6646.25	7725.05	0	7725.05
12	29.3679	293610	Bedrock	825	37	5451.41	6639.98	7716.74	0	7716.74
13	29.3679	283938	Bedrock	825	37	5383.27	6556.98	7606.61	0	7606.61
14	29.3679	273871	Bedrock	825	37	5302.53	6458.64	7476.09	0	7476.09
15	29.3679	263105	Bedrock	825	37	5203.74	6338.31	7316.41	0	7316.41
16	29.3679	263917	Bedrock	825	37	5306.56	6463.55	7482.6	0	7482.6
17	29.3679	265710	Bedrock	825	37	5428.47	6612.04	7679.68	0	7679.68
18	29.3679	264416	Bedrock	825	37	5495.28	6693.42	7787.66	0	7787.66
19	29.3679	239055	Bedrock	825	37	5109.17	6223.12	7163.56	0	7163.56
20	29.3679	184246	Bedrock	825	37	4144.64	5048.29	5604.5	0	5604.5
21	29.3679	140156	Bedrock	825	37	3355.35	4086.92	4328.72	0	4328.72
22	29.3679	133269	Bedrock	825	37	3275.4	3989.54	4199.5	0	4199.5
23	29.3679	116000	Bedrock	825	37	2983.18	3633.6	3727.14	0	3727.14
24	29.3679	86801.5	Bedrock	825	37	2436.25	2967.43	2843.1	0	2843.1
25	29.3679	30654.2	Bedrock	825	37	1308.64	1593.96	1020.45	0	1020.45

Interslice Data

Global Minimum Query (bishop simplified) - Safety Factor: 1.21803

Slice Number	X coordinate [ft]	Y coordinate - Bottom [ft]	Interslice Normal Force [lbs]	Interslice Shear Force [lbs]	Interslice Force Angle [degrees]
1	-594.914	1110.01	0	0	0
2	-565.546	1081.36	-5435.03	0	0
3	-536.179	1054.85	20322.1	0	0
4	-506.811	1030.28	63946.2	0	0
5	-477.443	1007.48	118464	0	0
6	-448.075	986.304	176300	0	0
7	-418.707	966.631	234680	0	0
8	-389.339	948.362	293616	0	0
9	-359.971	931.414	350074	0	0
10	-330.603	915.712	399311	0	0

 BYER GEOTECHNICAL INC.	Project			BG 21898 HARVARD-WESTLAKE SECTION 2										
	Analysis Description						CALCULATE THE SEISMIC STABILITY OF FAILURES ABOVE SOIL NAIL WALLS							
	Drawn By			R. ZWEIGLER		Scale		Company				BYER GEOTECHNICAL, INC.		
	Date						4/10/15			File Name			21898 Section 2 Above soil nails EQ updated.slim	

11	-301.235	901.195	439441	0	0
12	-271.867	887.808	469776	0	0
13	-242.499	875.503	489996	0	0
14	-213.132	864.241	500131	0	0
15	-183.764	853.983	500724	0	0
16	-154.396	844.701	492323	0	0
17	-125.028	836.366	475596	0	0
18	-95.6599	828.956	450358	0	0
19	-66.292	822.449	416548	0	0
20	-36.9241	816.828	376296	0	0
21	-7.55619	812.08	334787	0	0
22	21.8117	808.191	293860	0	0
23	51.1796	805.152	249208	0	0
24	80.5475	802.956	203543	0	0
25	109.915	801.598	161128	0	0
26	139.283	801.073	0	0	0

List Of Coordinates

External Boundary

X	Y
156	790
141	800
125	810
110	820
100	825
93	830
81	835
58	840
44	845
15	850
0	852
-30	875
-65	900
-165	925
-220	950
-270	975
-320	1000
-370	1025
-440	1050
-490	1075
-553	1100
-620	1116

 BYER GEOTECHNICAL INC.	<i>Project</i> BG 21898 HARVARD-WESTLAKE SECTION 2			
	<i>Analysis Description</i> CALCULATE THE SEISMIC STABILITY OF FAILURES ABOVE SOIL NAIL WALLS			
	<i>Drawn By</i> R. ZWEIGLER	<i>Scale</i>	<i>Company</i> BYER GEOTECHNICAL, INC.	
	<i>Date</i> 4/10/15	<i>File Name</i> 21898 Section 2 Above soil nails EQ updated.slim		

-620	675
430	675
430	720
202	720
202	719
190	719
183	768
165	767
161	783
159	790

 BYER GEOTECHNICAL INC.	<i>Project</i>		
	BG 21898 HARVARD-WESTLAKE SECTION 2		
	<i>Analysis Description</i>		
	CALCULATE THE SEISMIC STABILITY OF FAILURES ABOVE SOIL NAIL WALLS		
<i>Drawn By</i>	R. ZWEIGLER	<i>Scale</i>	<i>Company</i>
			BYER GEOTECHNICAL, INC.
<i>Date</i>	4/10/15	<i>File Name</i>	21898 Section 2 Above soil nails EQ updated.slim
SLIDE:INTERPRET 6.035			

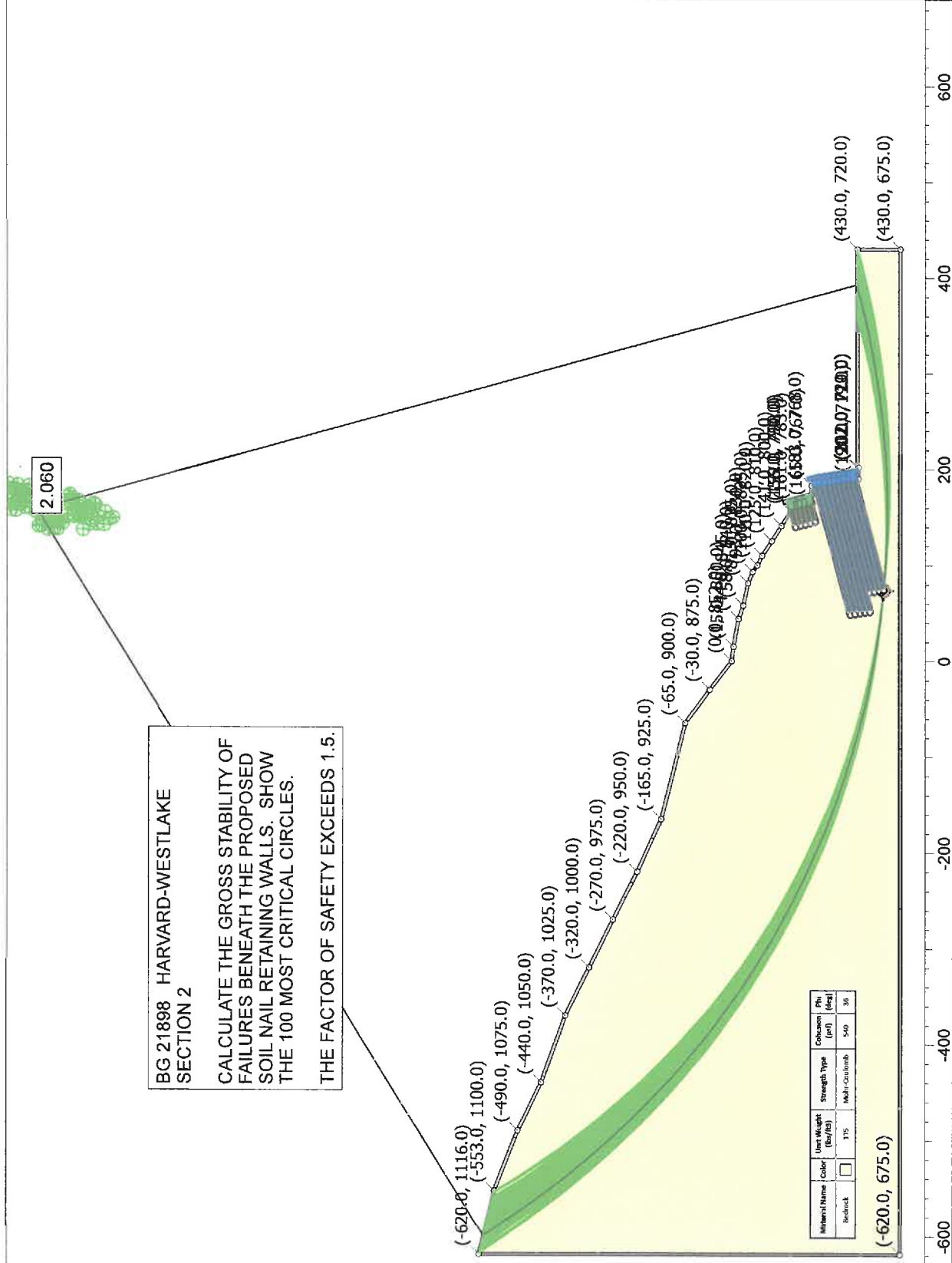
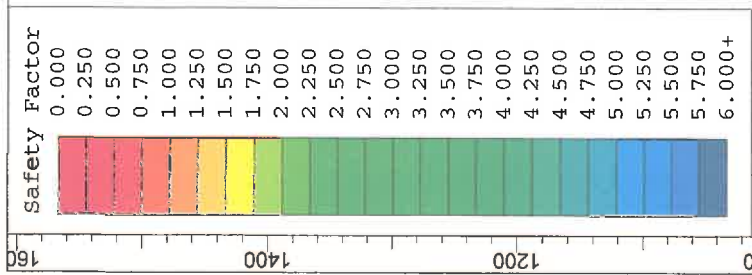

Project BG 21898 HARVARD-WESTLAKE SECTION 2

Analysis Description CALCULATE THE GROSS STABILITY OF FAILURES BELOW SOIL NAIL WALLS

Drawn By R. ZWEIGLER **Scale** 1:1854 **Company** BYER GEOTECHNICAL, INC.

Date 4/10/15 **File Name** 21898 Section 2 Below soil nails updated.slm

SLIDINTERPRET 6.034

Slide Analysis Information

BG 21898 HARVARD-WESTLAKE SECTION 2

Project Summary

File Name: 21898 Section 2 Below soil nails updated
Slide Modeler Version: 6.034
Project Title: BG 21898 HARVARD-WESTLAKE SECTION 2
Analysis: CALCULATE THE GROSS STABILITY OF FAILURES BELOW SOIL NAIL WALLS
Author: R. ZWEIGLER
Company: BYER GEOTECHNICAL, INC.
Date Created: 4/10/15

General Settings

Units of Measurement: Imperial Units
Time Units: days
Permeability Units: feet/second
Failure Direction: Left to Right
Data Output: Standard
Maximum Material Properties: 20
Maximum Support Properties: 20

Analysis Options

Analysis Methods Used

Bishop simplified

Number of slices: 25
Tolerance: 0.005
Maximum number of iterations: 50
Check $m\alpha < 0.2$: Yes
Initial trial value of FS: 1
Steffensen Iteration: Yes

Groundwater Analysis

Groundwater Method: Water Surfaces
Pore Fluid Unit Weight: 62.4 lbs/ft³
Advanced Groundwater Method: None

 BYER GEOTECHNICAL INC.	<i>Project</i> BG 21898 HARVARD-WESTLAKE SECTION 2		
	<i>Analysis Description</i> CALCULATE THE GROSS STABILITY OF FAILURES BELOW SOIL NAIL WALLS		
	<i>Drawn By</i> R. ZWEIGLER	<i>Scale</i>	<i>Company</i> BYER GEOTECHNICAL, INC.
	<i>Date</i> 4/10/15	<i>File Name</i> 21898 Section 2 Below soil nails updated.slim	

Random Numbers

Pseudo-random Seed: 10116

Random Number Generation Method: Park and Miller v.3

Surface Options

Surface Type: Circular

Search Method: Slope Search

Number of Surfaces: 5000

Upper Angle: Not Defined

Lower Angle: Not Defined

Composite Surfaces: Disabled

Reverse Curvature: Create Tension Crack

Minimum Elevation: Not Defined

Minimum Depth: Not Defined

Material Properties

Property	Bedrock
Color	<input type="checkbox"/>
Strength Type	Mohr-Coulomb
Unit Weight [lbs/ft ³]	115
Cohesion [psf]	540
Friction Angle [deg]	36
Water Surface	None
Ru Value	0

Support Properties

Soil Nail

Support Type: Soil Nail

Force Application: Passive

Out-of-Plane Spacing: 5 ft

Tensile Capacity: 93750 lb

Plate Capacity: 37100 lb

Bond Strength: 2413 lb/ft

Support 2

Support Type: Soil Nail

 BYER GEOTECHNICAL INC.	<i>Project</i> BG 21898 HARVARD-WESTLAKE SECTION 2		
	<i>Analysis Description</i> CALCULATE THE GROSS STABILITY OF FAILURES BELOW SOIL NAIL WALLS		
	<i>Drawn By</i> R. ZWEIGLER	<i>Scale</i>	<i>Company</i> BYER GEOTECHNICAL, INC.
	<i>Date</i> 4/10/15	<i>File Name</i> 21898 Section 2 Below soil nails updated.slim	

Force Application: Passive
 Out-of-Plane Spacing: 5 ft
 Tensile Capacity: 25000 lb
 Plate Capacity: 37100 lb
 Bond Strength: 1810 lb/ft

Global Minimums

Method: bishop simplified

FS: 2.060230
 Center: 156.698, 1576.396
 Radius: 888.359
 Left Slip Surface Endpoint: -600.159, 1111.262
 Right Slip Surface Endpoint: 392.852, 720.000
 Resisting Moment=8.90794e+009 lb-ft
 Driving Moment=4.32376e+009 lb-ft
 Total Slice Area=115913 ft²

Valid / Invalid Surfaces

Method: bishop simplified

Number of Valid Surfaces: 3817
 Number of Invalid Surfaces: 1183

Error Codes:

Error Code -103 reported for 1183 surfaces

Error Codes

The following errors were encountered during the computation:

-103 = Two surface / slope intersections, but one or more surface / nonslope external polygon intersections lie between them. This usually occurs when the slip surface extends past the bottom of the soil region, but may also occur on a benched slope model with two sets of Slope Limits.

Slice Data

Global Minimum Query (bishop simplified) - Safety Factor: 2.06023

Slice Number	Width [ft]	Weight [lbs]	Base Material	Base Cohesion [psf]	Base Friction Angle [degrees]	Shear Stress [psf]	Shear Strength [psf]	Base Normal Stress [psf]	Pore Pressure [psf]	Effective Normal Stress [psf]
1	39.7204	113481	Bedrock	540	36	832.824	1715.81	1618.36	0	1618.36
2	39.7204	310944	Bedrock	540	36	2089.35	4304.55	5181.45	0	5181.45

 BYER GEOTECHNICAL INC.	<i>Project</i>			BG 21898 HARVARD-WESTLAKE SECTION 2			
	<i>Analysis Description</i>						CALCULATE THE GROSS STABILITY OF FAILURES BELOW SOIL NAIL WALLS
	<i>Drawn By</i>			R. ZWEIGLER	<i>Scale</i>		<i>Company</i>
	<i>Date</i>			4/10/15		<i>File Name</i>	
SLIDEINTERPRET 6.034						21898 Section 2 Below soil nails updated.slim	

3	39.7204	454069	Bedrock	540	36	3093.18	6372.67	8027.97	0	8027.97
4	39.7204	556825	Bedrock	540	36	3881.75	7997.3	10264.1	0	10264.1
5	39.7204	643947	Bedrock	540	36	4592.44	9461.48	12279.4	0	12279.4
6	39.7204	725564	Bedrock	540	36	5285.24	10888.8	14243.9	0	14243.9
7	39.7204	773756	Bedrock	540	36	5756.35	11859.4	15579.9	0	15579.9
8	39.7204	799369	Bedrock	540	36	6069.23	12504	16467	0	16467
9	39.7204	811994	Bedrock	540	36	6286.09	12950.8	17082.1	0	17082.1
10	39.7204	813494	Bedrock	540	36	6416.76	13220	17452.5	0	17452.5
11	39.7204	810163	Bedrock	540	36	6506.36	13404.6	17706.7	0	17706.7
12	39.7204	817996	Bedrock	540	36	6680.23	13762.8	18199.6	0	18199.6
13	39.7204	833020	Bedrock	540	36	6911.8	14239.9	18856.3	0	18856.3
14	39.7204	827052	Bedrock	540	36	6975.14	14370.4	19035.9	0	19035.9
15	39.7204	747043	Bedrock	540	36	6424.04	13235	17473.1	0	17473.1
16	39.7204	686641	Bedrock	540	36	6017.19	12396.8	16319.5	0	16319.5
17	39.7204	672632	Bedrock	540	36	5991.42	12343.7	16246.4	0	16246.4
18	39.7204	627864	Bedrock	540	36	5696.69	11736.5	15410.7	0	15410.7
19	39.7204	527055	Bedrock	540	36	4898.69	10092.4	13147.8	0	13147.8
20	39.7204	337609	Bedrock	540	36	3282.54	6762.78	8564.92	0	8564.92
21	39.7204	135610	Bedrock	540	36	1500.31	3090.99	3511.13	0	3511.13
22	39.7204	120643	Bedrock	540	36	1386.94	2857.42	3189.65	0	3189.65
23	39.7204	96513.8	Bedrock	540	36	1184	2439.31	2614.17	0	2614.17
24	39.7204	63962.4	Bedrock	540	36	893.827	1841.49	1791.34	0	1791.34
25	39.7204	22779.4	Bedrock	540	36	509.382	1049.44	701.19	0	701.19

Interslice Data

Global Minimum Query (bishop simplified) - Safety Factor: 2.06023

Slice Number	X coordinate [ft]	Y coordinate - Bottom [ft]	Interslice Normal Force [lbs]	Interslice Shear Force [lbs]	Interslice Force Angle [degrees]
1	-600.159	1111.26	0	0	0
2	-560.439	1052.09	62736.6	0	0
3	-520.718	1001.69	241037	0	0
4	-480.998	957.909	469832	0	0
5	-441.278	919.427	710878	0	0
6	-401.557	885.358	947116	0	0
7	-361.837	855.075	1.16888e+006	0	0
8	-322.116	828.118	1.36058e+006	0	0
9	-282.396	804.14	1.51476e+006	0	0
10	-242.675	782.87	1.62882e+006	0	0
11	-202.955	764.095	1.70202e+006	0	0
12	-163.235	747.646	1.73526e+006	0	0

 BYER GEOTECHNICAL INC.	Project			BG 21898 HARVARD-WESTLAKE SECTION 2			
	Analysis Description			CALCULATE THE GROSS STABILITY OF FAILURES BELOW SOIL NAIL WALLS			
	Drawn By		R. ZWEIGLER	Scale		Company	BYER GEOTECHNICAL, INC.
	Date			4/10/15		File Name	21898 Section 2 Below soil nails updated.slim

13	-123.514	733.387	1.72987e+006	0	0
14	-83.7937	721.208	1.68544e+006	0	0
15	-44.0733	711.021	1.60275e+006	0	0
16	-4.35283	702.757	1.49241e+006	0	0
17	35.3676	696.361	1.35817e+006	0	0
18	75.088	691.793	1.19477e+006	0	0
19	114.808	689.025	1.01153e+006	0	0
20	154.529	688.039	830228	0	0
21	194.249	688.83	693280	0	0
22	233.97	691.404	624751	0	0
23	273.69	695.774	555811	0	0
24	313.411	701.968	492666	0	0
25	353.131	710.026	442787	0	0
26	392.852	720	0	0	0

List Of Coordinates

External Boundary

X	Y
156	790
141	800
125	810
110	820
100	825
93	830
81	835
58	840
44	845
15	850
0	852
-30	875
-65	900
-165	925
-220	950
-270	975
-320	1000
-370	1025
-440	1050
-490	1075
-553	1100
-620	1116

 BYER GEOTECHNICAL INC.	<i>Project</i> BG 21898 HARVARD-WESTLAKE SECTION 2		
	<i>Analysis Description</i> CALCULATE THE GROSS STABILITY OF FAILURES BELOW SOIL NAIL WALLS		
	<i>Drawn By</i> R. ZWEIGLER	<i>Scale</i>	<i>Company</i> BYER GEOTECHNICAL, INC.
	<i>Date</i> 4/10/15		<i>File Name</i> 21898 Section 2 Below soil nails updated.slim

-620	675
430	675
430	720
202	720
202	719
190	719
183	768
165	767
161	783
159	790



**BYER
GEOTECHNICAL
INC.**

<i>Project</i>			
BG 21898 HARVARD-WESTLAKE SECTION 2			
<i>Analysis Description</i>			
CALCULATE THE GROSS STABILITY OF FAILURES BELOW SOIL NAIL WALLS			
<i>Drawn By</i>	R. ZWEIGLER	<i>Scale</i>	<i>Company</i>
			BYER GEOTECHNICAL, INC.
<i>Date</i>	4/10/15		<i>File Name</i>
			21898 Section 2 Below soil nails updated.slim

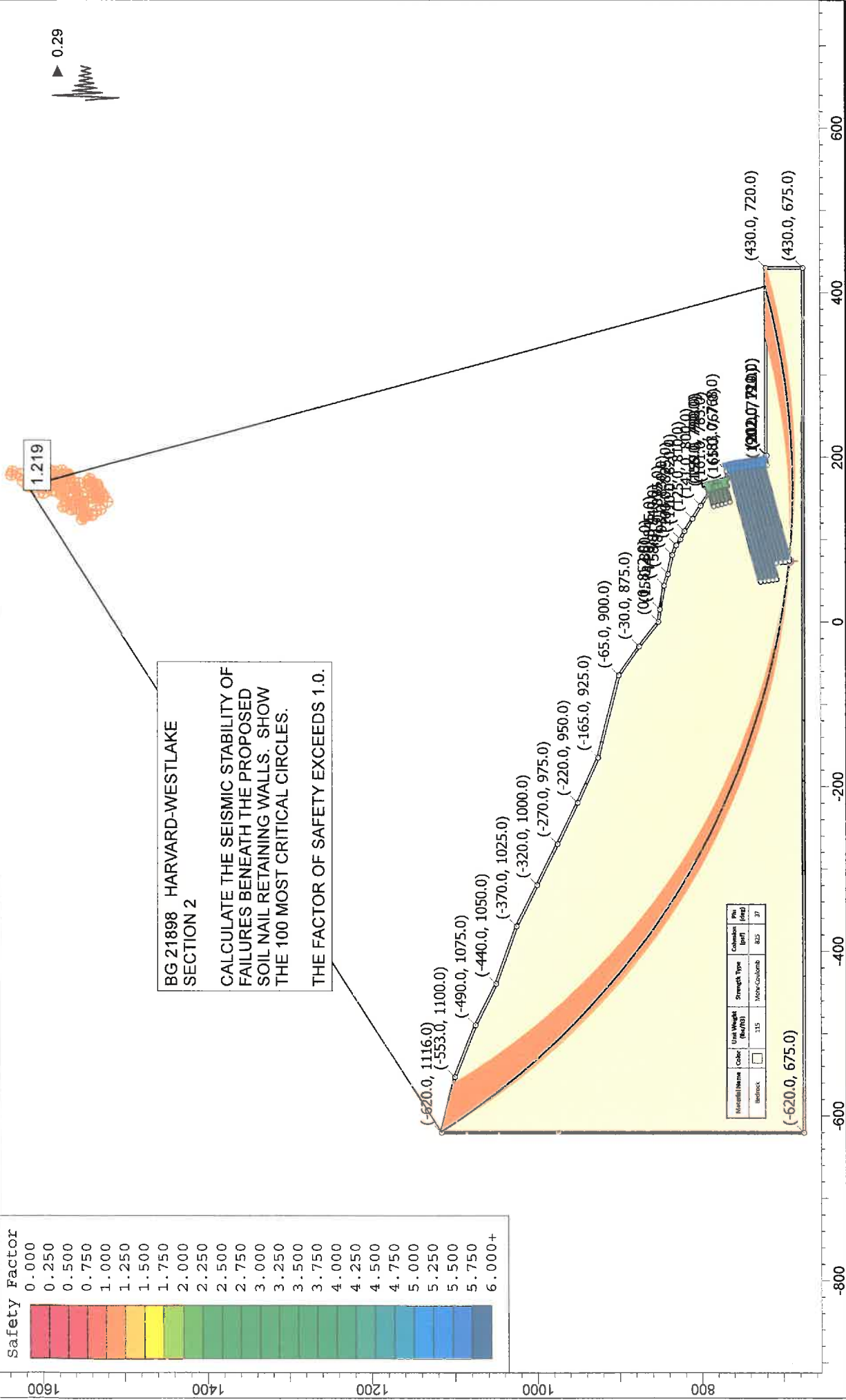
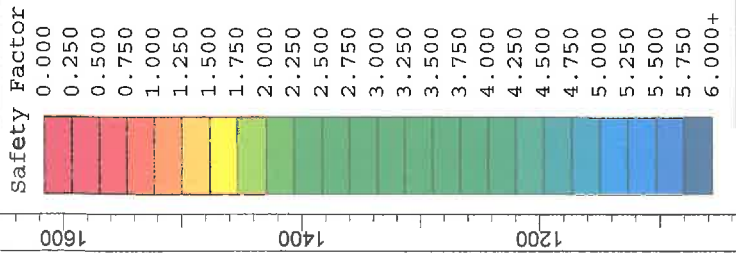

Project		BG 21898 HARVARD-WESTLAKE SECTION 2	
Analysis Description		CALCULATE THE SEISMIC STABILITY OF FAILURES BELOW SOIL NAIL WALLS	
Drawn By	R. ZWEIGLER	Scale	1:1942
Date	4/10/15	Company	BYER GEOTECHNICAL, INC.
File Name		21898 Section 2 Below soil nails EQ updated.slm	

Slide Analysis Information

BG 21898 HARVARD-WESTLAKE SECTION 2

Project Summary

File Name: 21898 Section 2 Below soil nails EQ updated
 Slide Modeler Version: 6.034
 Project Title: BG 21898 HARVARD-WESTLAKE SECTION 2
 Analysis: CALCULATE THE SEISMIC STABILITY OF FAILURES BELOW SOIL NAIL WALLS
 Author: R. ZWEIGLER
 Company: BYER GEOTECHNICAL, INC.
 Date Created: 4/10/15

General Settings

Units of Measurement: Imperial Units
 Time Units: days
 Permeability Units: feet/second
 Failure Direction: Left to Right
 Data Output: Standard
 Maximum Material Properties: 20
 Maximum Support Properties: 20

Analysis Options

Analysis Methods Used

Bishop simplified

Number of slices: 25
 Tolerance: 0.005
 Maximum number of iterations: 50
 Check malpha < 0.2: Yes
 Initial trial value of FS: 1
 Steffensen Iteration: Yes

Groundwater Analysis

Groundwater Method: Water Surfaces
 Pore Fluid Unit Weight: 62.4 lbs/ft³
 Advanced Groundwater Method: None

 BYER GEOTECHNICAL INC.	<i>Project</i>			BG 21898 HARVARD-WESTLAKE SECTION 2		
	<i>Analysis Description</i>					CALCULATE THE SEISMIC STABILITY OF FAILURES BELOW SOIL NAIL WALLS
	<i>Drawn By</i>		R. ZWEIGLER	<i>Scale</i>		<i>Company</i>
						BYER GEOTECHNICAL, INC.
<i>Date</i>			4/10/15		<i>File Name</i>	
					21898 Section 2 Below soil nails EQ updated.slim	

Random Numbers

Pseudo-random Seed: 10116

Random Number Generation Method: Park and Miller v.3

Surface Options

Surface Type: Circular

Search Method: Slope Search

Number of Surfaces: 5000

Upper Angle: Not Defined

Lower Angle: Not Defined

Composite Surfaces: Disabled

Reverse Curvature: Create Tension Crack

Minimum Elevation: Not Defined

Minimum Depth: Not Defined

Loading

Seismic Load Coefficient (Horizontal): 0.29

Material Properties

Property	Bedrock
Color	<input type="checkbox"/>
Strength Type	Mohr-Coulomb
Unit Weight [lbs/ft ³]	115
Cohesion [psf]	825
Friction Angle [deg]	37
Water Surface	None
Ru Value	0

Support Properties

Soil Nail

Support Type: Soil Nail

Force Application: Passive

Out-of-Plane Spacing: 5 ft

Tensile Capacity: 125000 lb

Plate Capacity: 37100 lb

 BYER GEOTECHNICAL INC.	<i>Project</i> BG 21898 HARVARD-WESTLAKE SECTION 2		
	<i>Analysis Description</i> CALCULATE THE SEISMIC STABILITY OF FAILURES BELOW SOIL NAIL WALLS		
	<i>Drawn By</i> R. ZWEIGLER	<i>Scale</i>	<i>Company</i> BYER GEOTECHNICAL, INC.
	<i>Date</i> 4/10/15	<i>File Name</i> 21898 Section 2 Below soil nails EQ updated.slim	

Bond Strength: 3217 lb/ft

Support 2

Support Type: Soil Nail
Force Application: Passive
Out-of-Plane Spacing: 5 ft
Tensile Capacity: 33333 lb
Plate Capacity: 37100 lb
Bond Strength: 2413 lb/ft

Global Minimums

Method: bishop simplified

FS: 1.219470
Center: 164.002, 1617.910
Radius: 930.381
Left Slip Surface Endpoint: -619.274, 1115.827
Right Slip Surface Endpoint: 407.656, 720.000
Resisting Moment=9.39663e+009 lb-ft
Driving Moment=7.70551e+009 lb-ft
Total Slice Area=119902 ft²

Valid / Invalid Surfaces

Method: bishop simplified

Number of Valid Surfaces: 3817
Number of Invalid Surfaces: 1183

Error Codes:

Error Code -103 reported for 1183 surfaces

Error Codes

The following errors were encountered during the computation:

-103 = Two surface / slope intersections, but one or more surface / nonslope external polygon intersections lie between them. This usually occurs when the slip surface extends past the bottom of the soil region, but may also occur on a benched slope model with two sets of Slope Limits.

Slice Data

Global Minimum Query (bishop simplified) - Safety Factor: 1.21947

 BYER GEOTECHNICAL INC.	Project			BG 21898 HARVARD-WESTLAKE SECTION 2	
	Analysis Description			CALCULATE THE SEISMIC STABILITY OF FAILURES BELOW SOIL NAIL WALLS	
	Drawn By	R. ZWEIGLER	Scale	Company	BYER GEOTECHNICAL, INC.
	Date	4/10/15		File Name	21898 Section 2 Below soil nails EQ updated.slim

Slice Number	Width [ft]	Weight [lbs]	Base Material	Base Cohesion [psf]	Base Friction Angle [degrees]	Shear Stress [psf]	Shear Strength [psf]	Base Normal Stress [psf]	Pore Pressure [psf]	Effective Normal Stress [psf]
1	41.0772	116049	Bedrock	825	37	1284.56	1566.48	983.98	0	983.98
2	41.0772	326057	Bedrock	825	37	3171.78	3867.89	4038.06	0	4038.06
3	41.0772	478453	Bedrock	825	37	4734.94	5774.12	6567.69	0	6567.69
4	41.0772	590277	Bedrock	825	37	6030.51	7354.03	8664.32	0	8664.32
5	41.0772	672530	Bedrock	825	37	7106.32	8665.94	10405.3	0	10405.3
6	41.0772	755580	Bedrock	825	37	8236.91	10044.7	12234.9	0	12234.9
7	41.0772	811630	Bedrock	825	37	9126.59	11129.6	13674.7	0	13674.7
8	41.0772	837087	Bedrock	825	37	9707.66	11838.2	14615.1	0	14615.1
9	41.0772	848936	Bedrock	825	37	10143.1	12369.2	15319.7	0	15319.7
10	41.0772	848701	Bedrock	825	37	10439.4	12730.5	15799.2	0	15799.2
11	41.0772	843113	Bedrock	825	37	10667.8	13009.1	16168.9	0	16168.9
12	41.0772	846555	Bedrock	825	37	11003	13417.8	16711.2	0	16711.2
13	41.0772	861791	Bedrock	825	37	11490.8	14012.7	17500.7	0	17500.7
14	41.0772	855746	Bedrock	825	37	11715.2	14286.3	17863.8	0	17863.8
15	41.0772	770535	Bedrock	825	37	10884.1	13272.8	16518.8	0	16518.8
16	41.0772	709137	Bedrock	825	37	10327	12593.5	15617.4	0	15617.4
17	41.0772	693141	Bedrock	825	37	10373.3	12649.9	15692.2	0	15692.2
18	41.0772	639821	Bedrock	825	37	9878.23	12046.2	14891	0	14891
19	41.0772	529011	Bedrock	825	37	8502.8	10368.9	12665.2	0	12665.2
20	41.0772	291295	Bedrock	825	37	5118.8	6242.22	7188.89	0	7188.89
21	41.0772	143525	Bedrock	825	37	2951	3598.65	3680.75	0	3680.75
22	41.0772	126900	Bedrock	825	37	2770.19	3378.16	3388.17	0	3388.17
23	41.0772	101545	Bedrock	825	37	2434.48	2968.78	2844.88	0	2844.88
24	41.0772	67307.8	Bedrock	825	37	1926.35	2349.12	2022.57	0	2022.57
25	41.0772	23972.7	Bedrock	825	37	1223.79	1492.38	885.643	0	885.643

Interslice Data

Global Minimum Query (bishop simplified) - Safety Factor: 1.21947

Slice Number	X coordinate [ft]	Y coordinate [ft]	Interslice Bottom [ft]	Interslice Normal Force [lbs]	Interslice Shear Force [lbs]	Interslice Force Angle [degrees]
1	-619.274	1115.83		0	0	0
2	-578.197	1056.88		38945.5	0	0
3	-537.119	1006.32		207526	0	0
4	-496.042	962.204		441765	0	0
5	-454.965	923.296		702618	0	0
6	-413.888	888.765		965375	0	0
7	-372.811	858.015	1.22276e+006		0	0

 BYER GEOTECHNICAL INC.	Project		BG 21898 HARVARD-WESTLAKE SECTION 2	
	Analysis Description		CALCULATE THE SEISMIC STABILITY OF FAILURES BELOW SOIL NAIL WALLS	
	Drawn By	R. ZWEIGLER	Scale	Company
	Date	4/10/15	File Name	21898 Section 2 Below soil nails EQ updated.slim
<small>SLIDEINTERPRET 6.034</small>				

8	-331.733	830.601	1.45852e+006	0	0
9	-290.656	806.187	1.65978e+006	0	0
10	-249.579	784.508	1.82191e+006	0	0
11	-208.502	765.355	1.94229e+006	0	0
12	-167.425	748.562	2.0206e+006	0	0
13	-126.348	733.995	2.05808e+006	0	0
14	-85.2704	721.544	2.05442e+006	0	0
15	-44.1932	711.122	2.00807e+006	0	0
16	-3.11601	702.661	1.92471e+006	0	0
17	37.9612	696.106	1.809e+006	0	0
18	79.0384	691.416	1.65783e+006	0	0
19	120.116	688.564	1.48053e+006	0	0
20	161.193	687.533	1.29813e+006	0	0
21	202.27	688.316	1.16695e+006	0	0
22	243.347	690.918	1.07791e+006	0	0
23	284.424	695.355	986014	0	0
24	325.501	701.653	897656	0	0
25	366.579	709.85	821555	0	0
26	407.656	720	0	0	0

List Of Coordinates

External Boundary

X	Y
156	790
141	800
125	810
110	820
100	825
93	830
81	835
58	840
44	845
15	850
0	852
-30	875
-65	900
-165	925
-220	950
-270	975
-320	1000

 BYER GEOTECHNICAL INC.	Project			BG 21898 HARVARD-WESTLAKE SECTION 2	
	Analysis Description			CALCULATE THE SEISMIC STABILITY OF FAILURES BELOW SOIL NAIL WALLS	
	Drawn By	R. ZWEIGLER	Scale	Company	BYER GEOTECHNICAL, INC.
	Date	4/10/15		File Name	21898 Section 2 Below soil nails EQ updated.slim

-370	1025
-440	1050
-490	1075
-553	1100
-620	1116
-620	675
430	675
430	720
202	720
202	719
190	719
183	768
165	767
161	783
159	790

1



**BYER
GEOTECHNICAL
INC.**

<i>Project</i>	BG 21898 HARVARD-WESTLAKE SECTION 2		
<i>Analysis Description</i>	CALCULATE THE SEISMIC STABILITY OF FAILURES BELOW SOIL NAIL WALLS		
<i>Drawn By</i>	R. ZWEIGLER	<i>Scale</i>	<i>Company</i> BYER GEOTECHNICAL, INC.
<i>Date</i>	4/10/15	<i>File Name</i>	21898 Section 2 Below soil nails EQ updated.slim

BG 21898 HARVARD-WESTLAKE SECTION 3

DETERMINE THE LOCATION OF THE 1.5 FACTOR OF SAFETY PLANE BEFORE ADDING SUPPORT FORCES FROM THE PROPOSED RETAINING WALL.

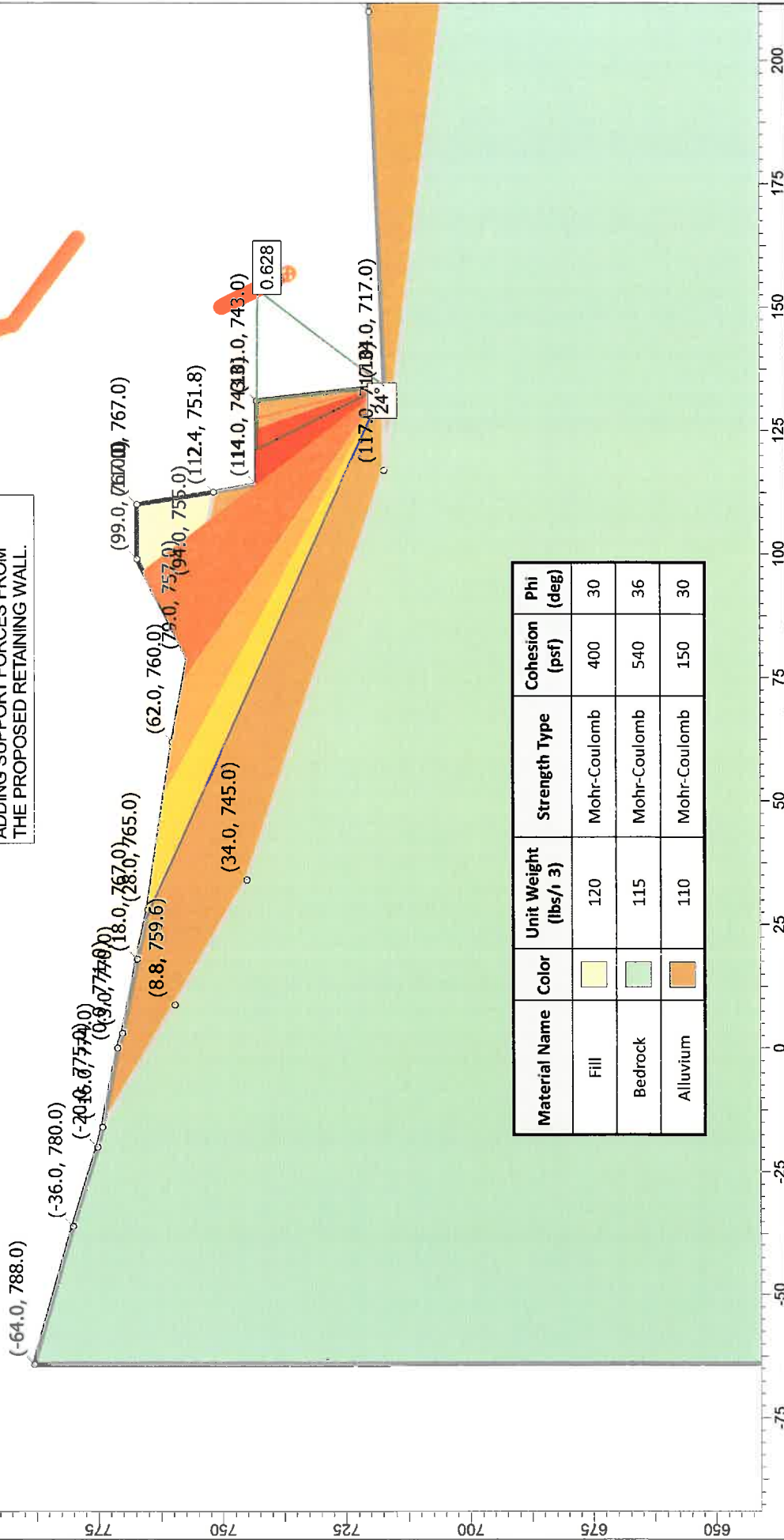

Material Name	Color	Unit Weight (lbs/ft ³)	Strength Type	Cohesion (psf)	Phi (deg)
Fill		120	Mohr-Coulomb	400	30
Bedrock		115	Mohr-Coulomb	540	36
Alluvium		110	Mohr-Coulomb	150	30

SLIDEPRESENT 6.03

Project: BG 21898 HARVARD WESTLAKE SECTION 3

Analysis Description: CALCULATE THE LOCATION OF THE 1.5 FACTOR OF SAFETY PLANE

Drawn By: R. ZWEIGLER Scale: 1:356 Company: BYER GEOTECHNICAL, INC.

Date: 2/7/2014, 3:00:17 PM File Name: 21898 Section 3 ver4.slm

Slide Analysis Information

BG 21898 HARVARD WESTLAKE SECTION 3

Project Summary

File Name: 21898 Section 3 ver4
Slide Modeler Version: 6.033
Project Title: BG 21898 HARVARD WESTLAKE SECTION 3
Analysis: CALCULATE THE LOCATION OF THE 1.5 FACTOR OF SAFETY PLANE
Author: R. ZWEIGLER
Company: BYER GEOTECHNICAL, INC.
Date Created: 2/7/2014, 3:00:17 PM

General Settings

Units of Measurement: Imperial Units
Time Units: days
Permeability Units: feet/second
Failure Direction: Left to Right
Data Output: Standard
Maximum Material Properties: 20
Maximum Support Properties: 20

Analysis Options

Analysis Methods Used

Janbu corrected

Number of slices: 25
Tolerance: 0.005
Maximum number of iterations: 50
Check $\alpha < 0.2$: Yes
Initial trial value of FS: 1
Steffensen Iteration: Yes

Groundwater Analysis

Groundwater Method: Water Surfaces
Pore Fluid Unit Weight: 62.4 lbs/ft³
Advanced Groundwater Method: None

 BYER GEOTECHNICAL INC.	<i>Project</i> BG 21898 HARVARD WESTLAKE SECTION 3		
	<i>Analysis Description</i> CALCULATE THE LOCATION OF THE 1.5 FACTOR OF SAFETY PLANE		
	<i>Drawn By</i> R. ZWEIGLER	<i>Scale</i>	<i>Company</i> BYER GEOTECHNICAL, INC.
	<i>Date</i> 2/7/2014, 3:00:17 PM	<i>File Name</i> 21898 Section 3 ver4.slim	

Random Numbers

Pseudo-random Seed: 10116

Random Number Generation Method: Park and Miller v.3

Surface Options

Surface Type: Non-Circular Block Search

Number of Surfaces: 5000

Pseudo-Random Surfaces: Enabled

Convex Surfaces Only: Disabled

Left Projection Angle (Start Angle): 95

Left Projection Angle (End Angle): 265



Right Projection Angle (Start Angle): -85

Right Projection Angle (End Angle): 85

Minimum Elevation: Not Defined

Minimum Depth: Not Defined

Material Properties

Property	Fill	Bedrock	Alluvium
Color			
Strength Type	Mohr-Coulomb	Mohr-Coulomb	Mohr-Coulomb
Unit Weight [lbs/ft3]	120	115	110
Cohesion [psf]	400	540	150
Friction Angle [deg]	30	36	30
Water Surface	None	None	None
Ru Value	0	0	0

Global Minimums

Method: janbu corrected

FS: 0.627705

Axis Location: 153.573, 742.854

Left Slip Surface Endpoint: 121.146, 743.000

Right Slip Surface Endpoint: 134.000, 717.000

Resisting Horizontal Force=3536.08 lb

Driving Horizontal Force=5633.35 lb

Total Slice Area=128.104 ft²

Global Minimum Coordinates

 BYER GEOTECHNICAL INC.	Project			BG 21898 HARVARD WESTLAKE SECTION 3	
	Analysis Description			CALCULATE THE LOCATION OF THE 1.5 FACTOR OF SAFETY PLANE	
	Drawn By	R. ZWEIGLER	Scale	Company	BYER GEOTECHNICAL, INC.
	Date	2/7/2014, 3:00:17 PM		File Name	21898 Section 3 ver4.slim

Method: janbu corrected

X	Y
121.146	743
134	717

Valid / Invalid Surfaces

Method: janbu corrected

Number of Valid Surfaces: 4124
 Number of Invalid Surfaces: 876

Error Codes:

Error Code -108 reported for 876 surfaces

Error Codes

The following errors were encountered during the computation:

-108 = Total driving moment or total driving force < 0.1. This is to limit the calculation of extremely high safety factors if the driving force is very small (0.1 is an arbitrary number).

Slice Data

Global Minimum Query (janbu corrected) - Safety Factor: 0.627705

Slice Number	Width [ft]	Weight [lbs]	Base Material	Base Cohesion [psf]	Base Friction Angle [degrees]	Shear Stress [psf]	Shear Strength [psf]	Base Normal Stress [psf]	Pore Pressure [psf]	Effective Normal Stress [psf]
1	0.514165	29.4103	Alluvium	150	30	102.45	64.3086	-148.422	0	-148.422
2	0.514165	88.2308	Alluvium	150	30	139.422	87.516	-108.226	0	-108.226
3	0.514165	147.051	Alluvium	150	30	176.394	110.723	-68.0292	0	-68.0292
4	0.514165	205.872	Alluvium	150	30	213.366	133.931	-27.8329	0	-27.8329
5	0.514165	264.692	Alluvium	150	30	250.337	157.138	12.3635	0	12.3635
6	0.514165	323.513	Alluvium	150	30	287.309	180.345	52.5597	0	52.5597
7	0.514165	382.333	Alluvium	150	30	324.281	203.553	92.7563	0	92.7563
8	0.514165	441.154	Alluvium	150	30	361.253	226.76	132.953	0	132.953
9	0.514165	499.974	Alluvium	150	30	398.224	249.968	173.149	0	173.149
10	0.514165	558.795	Alluvium	150	30	435.196	273.175	213.345	0	213.345
11	0.514165	617.616	Alluvium	150	30	472.168	296.382	253.541	0	253.541
12	0.514165	676.436	Alluvium	150	30	509.14	319.59	293.738	0	293.738
13	0.514165	735.257	Alluvium	150	30	546.112	342.797	333.934	0	333.934

 BYER GEOTECHNICAL INC.	Project			BG 21898 HARVARD WESTLAKE SECTION 3		
	Analysis Description			CALCULATE THE LOCATION OF THE 1.5 FACTOR OF SAFETY PLANE		
	Drawn By	R. ZWEIGLER	Scale	Company	BYER GEOTECHNICAL, INC.	
	Date	2/7/2014, 3:00:17 PM		File Name	21898 Section 3 ver4.slim	

14	0.514165	794.077	Alluvium	150	30	583.083	366.004	374.13	0	374.13
15	0.514165	852.898	Alluvium	150	30	620.056	389.212	414.326	0	414.326
16	0.514165	911.718	Alluvium	150	30	657.027	412.419	454.523	0	454.523
17	0.514165	970.539	Alluvium	150	30	693.998	435.626	494.719	0	494.719
18	0.514165	1029.36	Alluvium	150	30	730.971	458.834	534.915	0	534.915
19	0.514165	1088.18	Alluvium	150	30	767.942	482.041	575.111	0	575.111
20	0.514165	1059.2	Alluvium	150	30	749.73	470.609	555.31	0	555.31
21	0.514165	869.438	Alluvium	150	30	630.452	395.738	425.63	0	425.63
22	0.514165	676.23	Alluvium	150	30	509.01	319.508	293.596	0	293.596
23	0.514165	483.021	Alluvium	150	30	387.568	243.279	161.563	0	161.563
24	0.514165	289.813	Alluvium	150	30	266.127	167.049	29.53	0	29.53
25	0.514165	96.6042	Alluvium	150	30	144.685	90.8197	-102.503	0	-102.503

Interslice Data

Global Minimum Query (janbu corrected) - Safety Factor: 0.627705

Slice Number	X coordinate [ft]	Y coordinate - Bottom [ft]	Interslice Normal Force [lbs]	Interslice Shear Force [lbs]	Interslice Force Angle [degrees]
1	121.146	743	0	0	0
2	121.66	741.96	-206.627	0	0
3	122.174	740.92	-390.313	0	0
4	122.688	739.88	-551.057	0	0
5	123.203	738.84	-688.859	0	0
6	123.717	737.8	-803.72	0	0
7	124.231	736.76	-895.638	0	0
8	124.745	735.72	-964.615	0	0
9	125.259	734.68	-1010.65	0	0
10	125.773	733.64	-1033.74	0	0
11	126.288	732.6	-1033.9	0	0
12	126.802	731.56	-1011.11	0	0
13	127.316	730.52	-965.375	0	0
14	127.83	729.48	-896.701	0	0
15	128.344	728.44	-805.086	0	0
16	128.858	727.4	-690.529	0	0
17	129.373	726.36	-553.031	0	0
18	129.887	725.32	-392.591	0	0
19	130.401	724.28	-209.209	0	0
20	130.915	723.24	-2.88497	0	0
21	131.429	722.2	192.137	0	0
22	131.943	721.16	313.145	0	0
23	132.458	720.12	358.796	0	0

	Project			BG 21898 HARVARD WESTLAKE SECTION 3	
	Analysis Description			CALCULATE THE LOCATION OF THE 1.5 FACTOR OF SAFETY PLANE	
	Drawn By	R. ZWEIGLER	Scale	Company	BYER GEOTECHNICAL, INC.
	Date	2/7/2014, 3:00:17 PM		File Name	21898 Section 3 ver4.slim

24	132.972	719.08	329.09	0	0
25	133.486	718.04	224.028	0	0
26	134	717	0	0	0

List Of Coordinates

External Boundary

X	Y
79	757
62	760
28	765
18	767
3	770
0	771
-16	774
-20	775
-36	780
-64	788
-64	630
0	630
405	630
405	680
405	709.045
405	713
372	713
368	715
328	720
210	720
134	717
131	743
114	743
112.449	751.767
110	767
99	767

Material Boundary

X	Y
117	717
285	696
323	690



**BYER
GEOTECHNICAL
INC.**

<i>Project</i>			
BG 21898 HARVARD WESTLAKE SECTION 3			
<i>Analysis Description</i>			
CALCULATE THE LOCATION OF THE 1.5 FACTOR OF SAFETY PLANE			
<i>Drawn By</i>	R. ZWEIGLER	<i>Scale</i>	<i>Company</i>
			BYER GEOTECHNICAL, INC.
<i>Date</i>	2/7/2014, 3:00:17 PM		<i>File Name</i>
			21898 Section 3 ver4.slim

Material Boundary

X	Y
79	757
94	755
112.449	751.767

Material Boundary

X	Y
-16	774
8.75649	759.641
34	745
117	717
134	717



**BYER
GEOTECHNICAL
INC.**

<i>Project</i>			
BG 21898 HARVARD WESTLAKE SECTION 3			
<i>Analysis Description</i>			
CALCULATE THE LOCATION OF THE 1.5 FACTOR OF SAFETY PLANE			
<i>Drawn By</i>	R. ZWEIGLER	<i>Scale</i>	<i>Company</i>
			BYER GEOTECHNICAL, INC.
<i>Date</i>	2/7/2014, 3:00:17 PM		<i>File Name</i>
			21898 Section 3 ver4.slim

BG 21898 HARVARD WESTLAKE
SECTION 3

CALCULATE THE MINIMUM REQUIRED
EFP APPLIED TO THE FACE OF THE
PROPOSED SOIL NAIL CONFIGURATION
TO ACHIEVE A FACTOR OF SAFETY
OF 1.5.

THE RESULTS INDICATE THAT AN EFP
OF 20 PCF WILL ACHIEVE A FACTOR OF
SAFETY IN EXCESS OF 1.5.

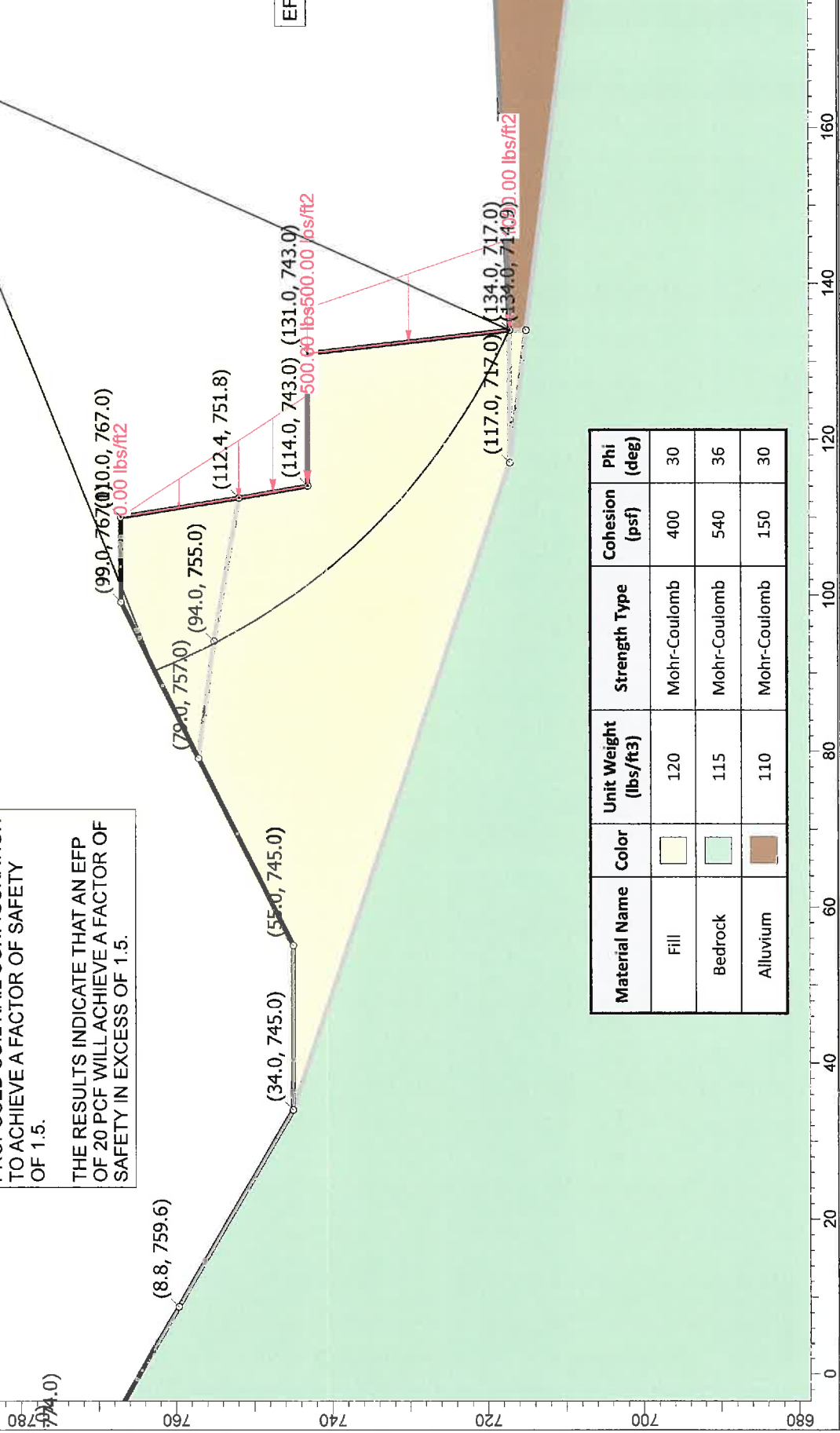

Project		BG 21898 HARVARD WESTLAKE SECTION 3	
Analysis Description			
CALCULATE THE MINIMUM REQUIRED EFP APPLIED TO SOIL NAIL WALLS TO ACHIEVE FS=1.5			
Drawn By	R. ZWEIGLER	Scale	1:233
Company		BYER GEOTECHNICAL, INC.	
Date	2/7/2014, 3:00:17 PM	File Name	
		21898 Section 3 ver-5 efp.slim	



Slide Analysis Information

BG 21898 HARVARD WESTLAKE SECTION 3

Project Summary

File Name: 21898 Section 3 ver5 efp
Slide Modeler Version: 6.035
Project Title: BG 21898 HARVARD WESTLAKE SECTION 3
Analysis: CALCULATE THE MINIMUM REQUIRED EFP APPLIED TO SOIL NAIL WALLS TO ACHIEVE FS=1.5
Author: R. ZWEIGLER
Company: BYER GEOTECHNICAL, INC.
Date Created: 2/7/2014, 3:00:17 PM

General Settings

Units of Measurement: Imperial Units
Time Units: days
Permeability Units: feet/second
Failure Direction: Left to Right
Data Output: Standard
Maximum Material Properties: 20
Maximum Support Properties: 20

Analysis Options

Analysis Methods Used

Bishop simplified

Number of slices: 25
Tolerance: 0.005
Maximum number of iterations: 50
Check malpha < 0.2: Yes
Initial trial value of FS: 1
Steffensen Iteration: Yes

Groundwater Analysis

Groundwater Method: Water Surfaces
Pore Fluid Unit Weight: 62.4 lbs/ft³
Advanced Groundwater Method: None

Random Numbers

 BYER GEOTECHNICAL INC. <small>SLIDEINTERPRET 6.035</small>	<i>Project</i> BG 21898 HARVARD WESTLAKE SECTION 3		
	<i>Analysis Description</i> CALCULATE THE MINIMUM REQUIRED EFP APPLIED TO SOIL NAIL WALLS TO ACHIEVE FS=1.5		
	<i>Drawn By</i> R. ZWEIGLER	<i>Scale</i>	<i>Company</i> BYER GEOTECHNICAL, INC.
	<i>Date</i> 2/7/2014, 3:00:17 PM		<i>File Name</i> 21898 Section 3 ver5 efp.slim

Surface Options

Surface Type: Circular
 Search Method: Auto Refine Search
 Divisions along slope: 25
 Circles per division: 10
 Number of iterations: 10
 Divisions to use in next iteration: 50%
 Composite Surfaces: Disabled
 Minimum Elevation: Not Defined
 Minimum Depth: Not Defined

Loading

2 Distributed Loads present



Distributed Load 1

Distribution: Triangular
 Magnitude 1 [psf]: 500
 Magnitude 2 [psf]: 0
 Orientation: Horizontal

Distributed Load 2

Distribution: Triangular
 Magnitude 1 [psf]: 1000
 Magnitude 2 [psf]: 500
 Orientation: Horizontal

Material Properties

Property	Fill	Bedrock	Alluvium
Color			
Strength Type	Mohr-Coulomb	Mohr-Coulomb	Mohr-Coulomb
Unit Weight [lbs/ft ³]	120	115	110
Cohesion [psf]	400	540	150
Friction Angle [deg]	30	36	30
Water Surface	None	None	None
Ru Value	0	0	0

Global Minimums

 BYER GEOTECHNICAL INC.	<i>Project</i> BG 21898 HARVARD WESTLAKE SECTION 3		
	<i>Analysis Description</i> CALCULATE THE MINIMUM REQUIRED EFP APPLIED TO SOIL NAIL WALLS TO ACHIEVE FS=1.5		
	<i>Drawn By</i> R. ZWEIGLER	<i>Scale</i>	<i>Company</i> BYER GEOTECHNICAL, INC.
	<i>Date</i> 2/7/2014, 3:00:17 PM		<i>File Name</i> 21898 Section 3 ver5 efp.slim

Method: bishop simplified

FS: 1.619110
 Center: 168.704, 794.208
 Radius: 84.646
 Left Slip Surface Endpoint: 90.184, 762.592
 Right Slip Surface Endpoint: 134.000, 717.003
 Resisting Moment=6.8663e+006 lb-ft
 Driving Moment=4.2408e+006 lb-ft
 Total Slice Area=864.055 ft2

Valid / Invalid Surfaces

Method: bishop simplified

Number of Valid Surfaces: 6845
 Number of Invalid Surfaces: 0

Slice Data

Global Minimum Query (bishop simplified) - Safety Factor: 1.61911

Slice Number	Width [ft]	Weight [lbs]	Base Material	Base Cohesion [psf]	Base Friction Angle [degrees]	Shear Stress [psf]	Shear Strength [psf]	Base Normal Stress [psf]	Pore Pressure [psf]	Effective Normal Stress [psf]
1	1.75263	517.559	Fill	400	30	193.276	312.935	-150.802	0	-150.802
2	1.75263	1500.88	Fill	400	30	320.643	519.156	206.385	0	206.385
3	1.75263	2393.64	Fill	400	30	445.462	721.252	556.426	0	556.426
4	1.75263	3217.08	Fill	400	30	567.503	918.849	898.671	0	898.671
5	1.75263	3984.89	Fill	400	30	686.774	1111.96	1233.15	0	1233.15
6	1.75263	4619.93	Fill	400	30	791.618	1281.72	1527.18	0	1527.18
7	1.75263	5118.21	Fill	400	30	879.811	1424.51	1774.5	0	1774.5
8	1.75263	5582.4	Fill	400	30	964.518	1561.66	2012.06	0	2012.06
9	1.75263	6016.65	Fill	400	30	1046.02	1693.62	2240.61	0	2240.61
10	1.75263	6424.17	Fill	400	30	1124.53	1820.73	2460.78	0	2460.78
11	1.75263	6807.59	Fill	400	30	1200.23	1943.31	2673.1	0	2673.1
12	1.75263	6617.75	Fill	400	30	1189.57	1926.05	2643.2	0	2643.2
13	1.75263	4783.19	Fill	400	30	923.822	1495.77	1897.92	0	1897.92
14	1.75263	3146.67	Fill	400	30	680.673	1102.08	1216.04	0	1216.04
15	1.75263	3090.9	Fill	400	30	680.408	1101.66	1215.3	0	1215.3
16	1.75263	3380.09	Fill	400	30	734.767	1189.67	1367.74	0	1367.74
17	1.75263	3654.07	Fill	400	30	787.423	1274.93	1515.42	0	1515.42
18	1.75263	3913.68	Fill	400	30	838.419	1357.49	1658.43	0	1658.43
19	1.75263	4159.67	Fill	400	30	887.796	1437.44	1796.89	0	1796.89
20	1.75263	4392.72	Fill	400	30	935.582	1514.81	1930.91	0	1930.91
21	1.75263	4613.4	Fill	400	30	981.817	1589.67	2060.57	0	2060.57

 BYER GEOTECHNICAL INC.	Project			BG 21898 HARVARD WESTLAKE SECTION 3													
	Analysis Description						CALCULATE THE MINIMUM REQUIRED EFP APPLIED TO SOIL NAIL WALLS TO ACHIEVE FS=1.5										
	Drawn By			R. ZWEIGLER			Scale			Company			BYER GEOTECHNICAL, INC.				
	Date						2/7/2014, 3:00:17 PM						File Name			21898 Section 3 ver5 efp.slim	

22	1.75263	4822.24	Fill	400	30	1026.53	1662.07	2185.97	0	2185.97
23	1.75263	5019.72	Fill	400	30	1069.75	1732.05	2307.18	0	2307.18
24	1.75263	4397.61	Fill	400	30	971.515	1572.99	2031.68	0	2031.68
25	1.75263	1511.91	Fill	400	30	476.02	770.728	642.118	0	642.118

Interslice Data

Global Minimum Query (bishop simplified) - Safety Factor: 1.61911

Slice Number	X coordinate [ft]	Y coordinate - Bottom [ft]	Interslice Normal Force [lbs]	Interslice Shear Force [lbs]	Interslice Force Angle [degrees]
1	90.1838	762.592	0	0	0
2	91.9364	758.546	-948.788	0	0
3	93.6891	754.994	-777.493	0	0
4	95.4417	751.809	213.602	0	0
5	97.1943	748.916	1819.32	0	0
6	98.947	746.26	3890.23	0	0
7	100.7	743.805	6252.03	0	0
8	102.452	741.523	8760.48	0	0
9	104.205	739.391	11359.1	0	0
10	105.958	737.393	14002.2	0	0
11	107.71	735.516	16651.6	0	0
12	109.463	733.747	19275.6	0	0
13	111.215	732.078	20999.5	0	0
14	112.968	730.501	19494.2	0	0
15	114.721	729.01	17514.1	0	0
16	116.473	727.597	18038	0	0
17	118.226	726.26	18580	0	0
18	119.979	724.992	19120.9	0	0
19	121.731	723.791	19643.5	0	0
20	123.484	722.653	20132.6	0	0
21	125.236	721.575	20574.5	0	0
22	126.989	720.554	20956.7	0	0
23	128.742	719.589	21268	0	0
24	130.494	718.676	21498.4	0	0
25	132.247	717.815	14975.5	0	0
26	134	717.003	0	0	0

List Of Coordinates

Distributed Load

X	Y
114	743

 BYER GEOTECHNICAL INC.	Project			BG 21898 HARVARD WESTLAKE SECTION 3		
	Analysis Description					CALCULATE THE MINIMUM REQUIRED EFP APPLIED TO SOIL NAIL WALLS TO ACHIEVE FS=1.5
	Drawn By	R. ZWEIGLER	Scale	Company	BYER GEOTECHNICAL, INC.	
	Date	2/7/2014, 3:00:17 PM		File Name	21898 Section 3 ver5 efp.slim	

112.449	751.767
110	767

Distributed Load

X	Y
134	717
131	743

External Boundary

X	Y
79	757
55	745
34	745
8.75649	759.641
-16	774
-20	775
-36	780
-64	788
-64	630
0	630
405	630
405	680
405	709.045
405	713
372	713
368	715
328	720
210	720
134	717
131	743
114	743
112.449	751.767
110	767
99	767

Material Boundary

X	Y
117	717
134	714.875
285	696
323	690
405	680

 <p>BYER GEOTECHNICAL INC.</p>	<i>Project</i>			BG 21898 HARVARD WESTLAKE SECTION 3		
	<i>Analysis Description</i>					CALCULATE THE MINIMUM REQUIRED EFP APPLIED TO SOIL NAIL WALLS TO ACHIEVE FS=1.5
	<i>Drawn By</i>		R. ZWEIGLER	<i>Scale</i>	<i>Company</i>	BYER GEOTECHNICAL, INC.
	<i>Date</i>			2/7/2014, 3:00:17 PM		<i>File Name</i>
SLIDEINTERPRET 6.035						

Material Boundary

X	Y
79	757
94	755
112.449	751.767

Material Boundary

X	Y
34	745
117	717
134	717

Material Boundary

X	Y
134	714.875
134	717

 BYER GEOTECHNICAL INC.	<i>Project</i> BG 21898 HARVARD WESTLAKE SECTION 3		
	<i>Analysis Description</i> CALCULATE THE MINIMUM REQUIRED EFP APPLIED TO SOIL NAIL WALLS TO ACHIEVE FS=1.5		
	<i>Drawn By</i> R. ZWEIGLER	<i>Scale</i>	<i>Company</i> BYER GEOTECHNICAL, INC.
	<i>Date</i> 2/7/2014, 3:00:17 PM		<i>File Name</i> 21898 Section 3 ver5 efp.slim

BG 21898 HARVARD WESTLAKE
SECTION 3

CALCULATE THE MINIMUM REQUIRED EFP APPLIED TO THE FACE OF THE PROPOSED SOIL NAIL CONFIGURATION TO ACHIEVE A FACTOR OF SAFETY OF 1.0 UNDER SEISMIC LOADING.
NOTE: THE SEARCH WAS LIMITED TO THE UPSLOPE DISTANCE RESULTING IN THE MOST CRITICAL FAILURE UNDER STATIC CONDITIONS.

THE RESULTS INDICATE THAT AN EFP OF 20 PCF WILL ACHIEVE A FACTOR OF SAFETY IN EXCESS OF 1.0.

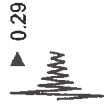

1.037

EFP = 20 PCF

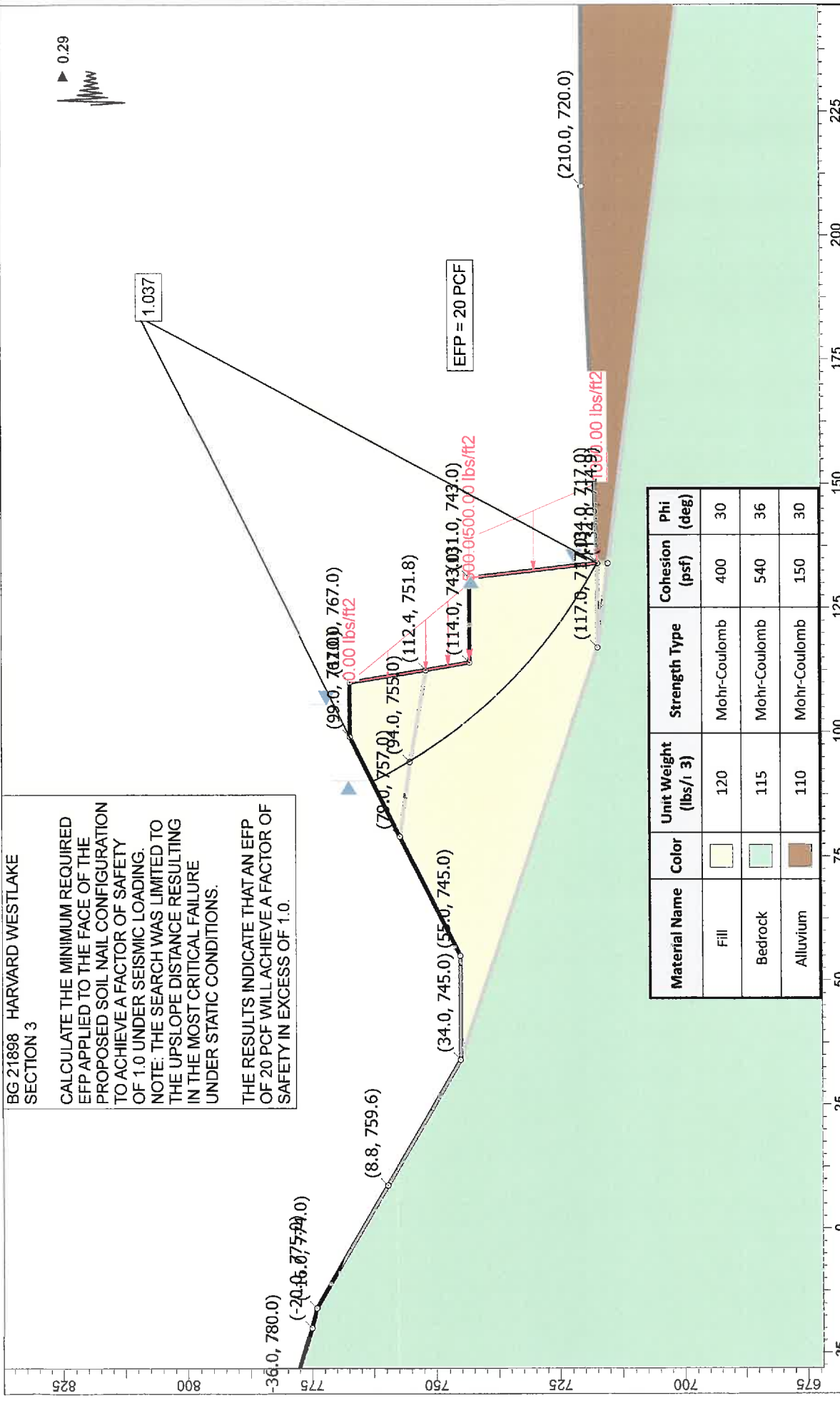

Material Name	Color	Unit Weight (lbs/ft ³)	Strength Type	Cohesion (psf)	Phi (deg)
Fill	[Yellow Box]	120	Mohr-Coulomb	400	30
Bedrock	[Green Box]	115	Mohr-Coulomb	540	36
Alluvium	[Brown Box]	110	Mohr-Coulomb	150	30

BYER GEOTECHNICAL INC.

BG 21898 HARVARD WESTLAKE SECTION 3

ANALYSIS DESCRIPTION: CALCULATE THE MINIMUM REQUIRED EFP APPLIED TO SOIL NAIL WALLS TO ACHIEVE FS=1.0 (SEISMIC)

DRAWN BY: R. ZWEIFLER SCALE: 1:320 COMPANY: BYER GEOTECHNICAL, INC.

DATE: 2/7/2014, 3:00:17 PM FILE NAME: 21898 Section 3 ver5 efp EQ.slim

Slide Analysis Information

BG 21898 HARVARD WESTLAKE SECTION 3

Project Summary

File Name: 21898 Section 3 ver5 efp EQ
Slide Modeler Version: 6.035
Project Title: BG 21898 HARVARD WESTLAKE SECTION 3
Analysis: CALCULATE THE MINIMUM REQUIRED EFP APPLIED TO SOIL NAIL WALLS TO ACHIEVE FS=1.0 (SEISMIC)
Author: R. ZWEIGLER
Company: BYER GEOTECHNICAL, INC.
Date Created: 2/7/2014, 3:00:17 PM

General Settings

Units of Measurement: Imperial Units
Time Units: days
Permeability Units: feet/second
Failure Direction: Left to Right
Data Output: Standard
Maximum Material Properties: 20
Maximum Support Properties: 20

Analysis Options

Analysis Methods Used

Bishop simplified

Number of slices: 25
Tolerance: 0.005
Maximum number of iterations: 50
Check malpha < 0.2: Yes
Initial trial value of FS: 1
Steffensen Iteration: Yes

Groundwater Analysis

Groundwater Method: Water Surfaces
Pore Fluid Unit Weight: 62.4 lbs/ft³
Advanced Groundwater Method: None

Random Numbers

 BYER GEOTECHNICAL INC.	Project BG 21898 HARVARD WESTLAKE SECTION 3		
	Analysis CALCULATE THE MINIMUM REQUIRED EFP APPLIED TO SOIL NAIL WALLS TO ACHIEVE FS=1.0 (SEISMIC)		
	Drawn By R. ZWEIGLER	Scale	Company BYER GEOTECHNICAL, INC.
	Date 2/7/2014, 3:00:17 PM	File Name 21898 Section 3 ver5 efp EQ.slim	

SLIDEINTERPRET 6.035

Surface Options

Surface Type: Circular
 Search Method: Auto Refine Search
 Divisions along slope: 25
 Circles per division: 10
 Number of iterations: 10
 Divisions to use in next iteration: 50%
 Composite Surfaces: Disabled
 Minimum Elevation: Not Defined
 Minimum Depth: Not Defined

Loading

Seismic Load Coefficient (Horizontal): 0.29
 2 Distributed Loads present



Distributed Load 1

Distribution: Triangular
 Magnitude 1 [psf]: 500
 Magnitude 2 [psf]: 0
 Orientation: Horizontal

Distributed Load 2

Distribution: Triangular
 Magnitude 1 [psf]: 1000
 Magnitude 2 [psf]: 500
 Orientation: Horizontal

Material Properties

Property	Fill	Bedrock	Alluvium
Color			
Strength Type	Mohr-Coulomb	Mohr-Coulomb	Mohr-Coulomb
Unit Weight [lbs/ft3]	120	115	110
Cohesion [psf]	400	540	150
Friction Angle [deg]	30	36	30
Water Surface	None	None	None
Ru Value	0	0	0

 BYER GEOTECHNICAL INC.	Project BG 21898 HARVARD WESTLAKE SECTION 3		
	Analysis Description CALCULATE THE MINIMUM REQUIRED EFP APPLIED TO SOIL NAIL WALLS TO ACHIEVE FS=1.0 (SEISMIC)		
	Drawn By R. ZWEIGLER	Scale	Company BYER GEOTECHNICAL, INC.
	Date 2/7/2014, 3:00:17 PM		File Name 21898 Section 3 ver5 efp EQ.slim
SLIDEINTERPRET 6.035			

Global Minimums

Method: bishop simplified

FS: 1.037000
 Center: 183.649, 809.036
 Radius: 104.574
 Left Slip Surface Endpoint: 90.001, 762.500
 Right Slip Surface Endpoint: 134.000, 717.000
 Resisting Moment=7.10082e+006 lb-ft
 Driving Moment=6.84744e+006 lb-ft
 Total Slice Area=818.185 ft2

Valid / Invalid Surfaces

Method: bishop simplified

Number of Valid Surfaces: 12341
 Number of Invalid Surfaces: 0

Slice Data

Global Minimum Query (bishop simplified) - Safety Factor: 1.037

Slice Number	Width [ft]	Weight [lbs]	Base Material	Base Cohesion [psf]	Base Friction Angle [degrees]	Shear Stress [psf]	Shear Strength [psf]	Base Normal Stress [psf]	Pore Pressure [psf]	Effective Normal Stress [psf]
1	1.75998	450.417	Fill	400	30	255.075	264.513	-234.67	0	-234.67
2	1.75998	1322.34	Fill	400	30	405.219	420.212	35.0076	0	35.0076
3	1.75998	2141.26	Fill	400	30	555.993	576.565	305.82	0	305.82
4	1.75998	2915.57	Fill	400	30	706.829	732.982	576.742	0	576.742
5	1.75998	3651.53	Fill	400	30	857.364	889.086	847.123	0	847.123
6	1.75998	4280.93	Fill	400	30	994.158	1030.94	1092.83	0	1092.83
7	1.75998	4769.02	Fill	400	30	1108.95	1149.98	1299	0	1299
8	1.75998	5229.31	Fill	400	30	1221.19	1266.37	1500.6	0	1500.6
9	1.75998	5665.52	Fill	400	30	1331.16	1380.41	1698.12	0	1698.12
10	1.75998	6079.77	Fill	400	30	1438.91	1492.15	1891.66	0	1891.66
11	1.75998	6473.84	Fill	400	30	1544.51	1601.66	2081.33	0	2081.33
12	1.75998	6380.88	Fill	400	30	1552.34	1609.78	2095.41	0	2095.41
13	1.75998	4585.97	Fill	400	30	1205.25	1249.85	1471.98	0	1471.98
14	1.75998	2905.64	Fill	400	30	869.808	901.991	869.474	0	869.474
15	1.75998	2807.01	Fill	400	30	861.706	893.589	854.923	0	854.923
16	1.75998	3119.27	Fill	400	30	941.836	976.684	998.845	0	998.845
17	1.75998	3417.96	Fill	400	30	1020.53	1058.29	1140.19	0	1140.19
18	1.75998	3703.77	Fill	400	30	1097.79	1138.41	1278.96	0	1278.96
19	1.75998	3977.32	Fill	400	30	1173.62	1217.05	1415.17	0	1415.17
20	1.75998	4239.15	Fill	400	30	1248.03	1294.21	1548.82	0	1548.82

 BYER GEOTECHNICAL INC.	Project			BG 21898 HARVARD WESTLAKE SECTION 3			
	Analysis Method: THE MINIMUM REQUIRED EFP APPLIED TO SOIL NAIL WALLS TO ACHIEVE FS=1.0 (SEISMIC)						
	Drawn By	R. ZWEIGLER	Scale	Company			BYER GEOTECHNICAL, INC.
	Date	2/7/2014, 3:00:17 PM		File Name	21898 Section 3 ver5 efp EQ.slim		

21	1.75998	4489.77	Fill	400	30	1321.03	1369.91	1679.93	0	1679.93
22	1.75998	4729.63	Fill	400	30	1392.62	1444.15	1808.52	0	1808.52
23	1.75998	4959.14	Fill	400	30	1462.82	1516.94	1934.59	0	1934.59
24	1.75998	4379.09	Fill	400	30	1340.2	1389.79	1714.37	0	1714.37
25	1.75998	1508.14	Fill	400	30	660.018	684.439	492.662	0	492.662

Interslice Data

Global Minimum Query (bishop simplified) - Safety Factor: 1.037

Slice Number	X coordinate [ft]	Y coordinate - Bottom [ft]	Interslice Normal Force [lbs]	Interslice Shear Force [lbs]	Interslice Force Angle [degrees]
1	90.0005	762.5	0	0	0
2	91.7605	759.115	-1112.7	0	0
3	93.5205	756.003	-1333.39	0	0
4	95.2804	753.12	-809.032	0	0
5	97.0404	750.431	343.519	0	0
6	98.8004	747.91	2028.72	0	0
7	100.56	745.539	4112.53	0	0
8	102.32	743.3	6452.67	0	0
9	104.08	741.18	9000.98	0	0
10	105.84	739.169	11716.6	0	0
11	107.6	737.257	14563.9	0	0
12	109.36	735.437	17511.4	0	0
13	111.12	733.702	19753.7	0	0
14	112.88	732.046	18618	0	0
15	114.64	730.465	16515.6	0	0
16	116.4	728.953	17105.5	0	0
17	118.16	727.508	17796.5	0	0
18	119.92	726.125	18568.7	0	0
19	121.68	724.801	19403.7	0	0
20	123.44	723.534	20284.6	0	0
21	125.2	722.322	21195.9	0	0
22	126.96	721.161	22123	0	0
23	128.72	720.05	23052.7	0	0
24	130.48	718.988	23972.4	0	0
25	132.24	717.971	18099.2	0	0
26	134	717	0	0	0

List Of Coordinates

Distributed Load

 BYER GEOTECHNICAL INC.	Project			BG 21898 HARVARD WESTLAKE SECTION 3			
	Analysis Description						THE MINIMUM REQUIRED EFP APPLIED TO SOIL NAIL WALLS TO ACHIEVE FS=1.0 (SEISMIC)
	Drawn By		R. ZWEIGLER		Scale	Company	
	Date		2/7/2014, 3:00:17 PM		File Name		21898 Section 3 ver5 efp EQ.slim
SLIDEINTERPRET 6.035							

X	Y
114	743
112.449	751.767
110	767

Distributed Load

X	Y
134	717
131	743

External Boundary

X	Y
79	757
55	745
34	745
8.75649	759.641
-16	774
-20	775
-36	780
-64	788
-64	630
0	630
405	630
405	680
405	709.045
405	713
372	713
368	715
328	720
210	720
134	717
131	743
114	743
112.449	751.767
110	767
99	767

Material Boundary

X	Y
117	717
134	714.875
285	696

 BYER GEOTECHNICAL INC.	<i>Project</i> BG 21898 HARVARD WESTLAKE SECTION 3		
	<i>Analysis Description</i> CALCULATE THE MINIMUM REQUIRED EFP APPLIED TO SOIL NAIL WALLS TO ACHIEVE FS=1.0 (SEISMIC)		
	<i>Drawn By</i> R. ZWEIGLER	<i>Scale</i>	<i>Company</i> BYER GEOTECHNICAL, INC.
	<i>Date</i> 2/7/2014, 3:00:17 PM		<i>File Name</i> 21898 Section 3 ver5 efp EQ.slim
<small>SLIDEINTERPRET 6.035</small>			

323	690
405	680

Material Boundary

X	Y
79	757
94	755
112.449	751.767

Material Boundary

X	Y
34	745
117	717
134	717

Material Boundary

X	Y
134	714.875
134	717

 <p>BYER GEOTECHNICAL INC.</p>	<i>Project</i> BG 21898 HARVARD WESTLAKE SECTION 3		
	<i>Analysis Description</i> CALCULATE THE MINIMUM REQUIRED EFP APPLIED TO SOIL NAIL WALLS TO ACHIEVE FS=1.0 (SEISMIC)		
	<i>Drawn By</i> R. ZWEIGLER	<i>Scale</i>	<i>Company</i> BYER GEOTECHNICAL, INC.
	<i>Date</i> 2/7/2014, 3:00:17 PM		<i>File Name</i> 21898 Section 3 ver5 efp EQ.slim

BG 21898 HARVARD WESTLAKE SECTION 3

DETERMINE THE FAILURE SURFACE WITH THE LOWEST FACTOR OF SAFETY TO DEFINE THE ACTIVE WEDGE.

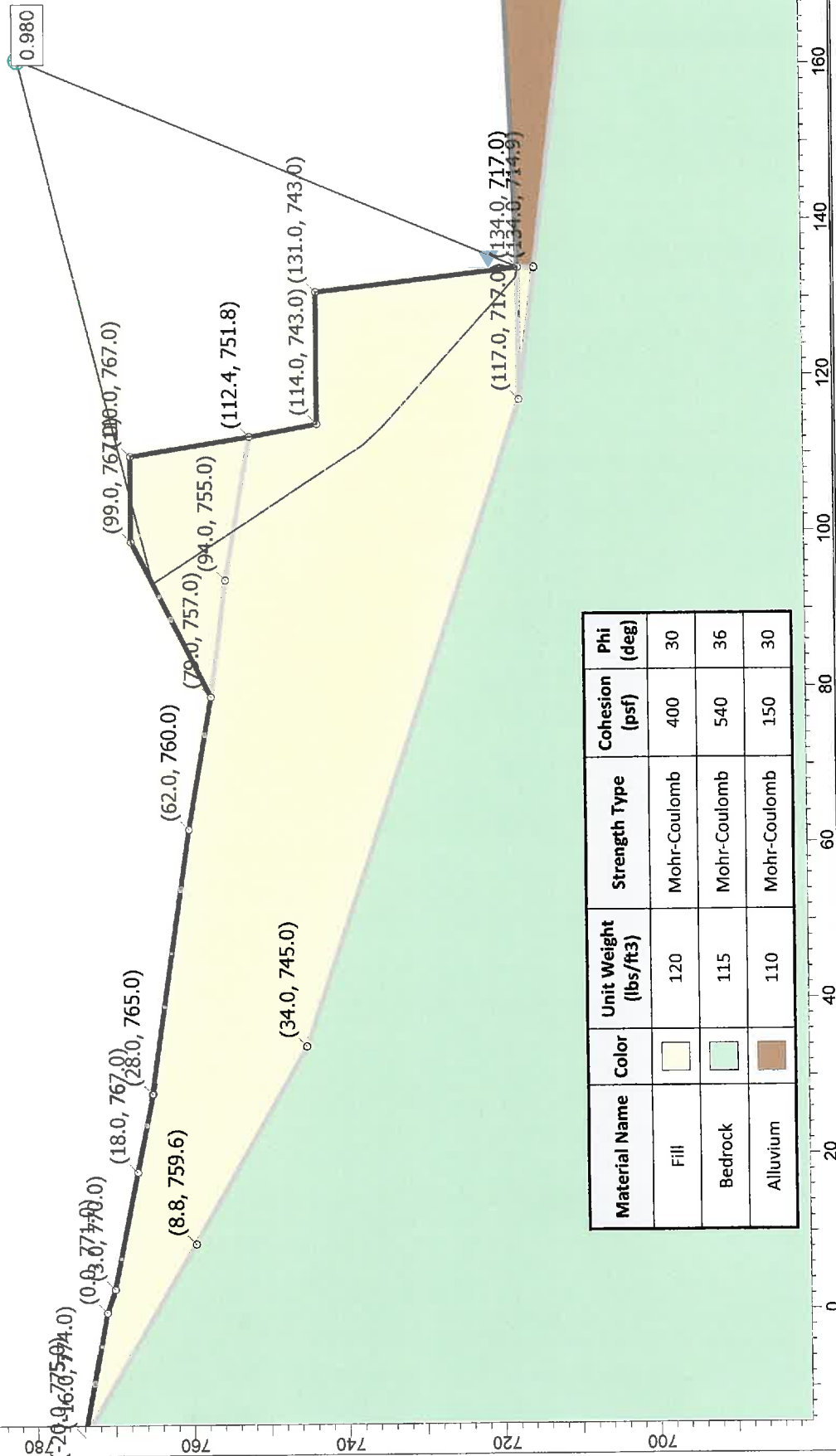

Material Name	Color	Unit Weight (lbs/ft ³)	Strength Type	Cohesion (psf)	Phi (deg)
Fill	[Yellow Box]	120	Mohr-Coulomb	400	30
Bedrock	[Green Box]	115	Mohr-Coulomb	540	36
Alluvium	[Brown Box]	110	Mohr-Coulomb	150	30



BYER GEOTECHNICAL INC.

SLIDEINTERPRET 6.035

Project

BG 21898 HARVARD WESTLAKE SECTION 3

Analysis Description

CALCULATE THE LOCATION OF THE MOST CRITICAL FAILURE THROUGH THE SOIL NAIL WALLS

Drawn By

R. ZWEIGLER

Scale

1:247

Company

BYER GEOTECHNICAL, INC.

Date

5/18/2015

File Name

21898 Section 3 ver4 active wedge.slim

Slide Analysis Information

BG 21898 HARVARD WESTLAKE SECTION 3

Project Summary

File Name: 21898 Section 3 ver4 active wedge
Slide Modeler Version: 6.035
Project Title: BG 21898 HARVARD WESTLAKE SECTION 3
Analysis: CALCULATE THE LOCATION OF THE MOST CRITICAL FAILURE THROUGH THE SOIL NAIL WALLS
Author: R. ZWEIGLER
Company: BYER GEOTECHNICAL, INC.
Date Created: 5/18/2015

General Settings

Units of Measurement: Imperial Units
Time Units: days
Permeability Units: feet/second
Failure Direction: Left to Right
Data Output: Standard
Maximum Material Properties: 20
Maximum Support Properties: 20

Analysis Options

Analysis Methods Used

Janbu corrected

Number of slices: 25
Tolerance: 0.005
Maximum number of iterations: 50
Check malpha < 0.2: Yes
Initial trial value of FS: 1
Steffensen Iteration: Yes

Groundwater Analysis



Groundwater Method: Water Surfaces
Pore Fluid Unit Weight: 62.4 lbs/ft³
Advanced Groundwater Method: None

Random Numbers

 BYER GEOTECHNICAL INC. <small>SLIDEINTERPRET 6.035</small>	<i>Project</i> BG 21898 HARVARD WESTLAKE SECTION 3		
	<i>Analysis Description</i> CALCULATE THE LOCATION OF THE MOST CRITICAL FAILURE THROUGH THE SOIL NAIL WALLS		
	<i>Drawn By</i> R. ZWEIGLER	<i>Scale</i>	<i>Company</i> BYER GEOTECHNICAL, INC.
	<i>Date</i> 5/18/2015		<i>File Name</i> 21898 Section 3 ver4 active wedge.slim

Surface Options

Material Properties

Property	Fill	Bedrock	Alluvium
Color			
Strength Type	Mohr-Coulomb	Mohr-Coulomb	Mohr-Coulomb
Unit Weight [lbs/ft3]	120	115	110
Cohesion [psf]	400	540	150
Friction Angle [deg]	30	36	30
Water Surface	None	None	None
Ru Value	0	0	0

Global Minimums

Method: janbu corrected

FS: 0.979600
 Axis Location: 161.095, 781.054
 Left Slip Surface Endpoint: 93.595, 764.297
 Right Slip Surface Endpoint: 134.000, 717.000
 Resisting Horizontal Force=36615.7 lb
 Driving Horizontal Force=37378.3 lb
 Total Slice Area=634.591 ft2

Global Minimum Coordinates

Method: janbu corrected

X	Y
93.5946	764.297
98.2472	757.142
101.455	752.208
106.344	744.69
111.233	737.171
113.655	734.55
123.272	725.81
132.655	717.282
134	717

 <p>BYER GEOTECHNICAL INC.</p>	Project			BG 21898 HARVARD WESTLAKE SECTION 3	
	Analysis Description				CALCULATE THE LOCATION OF THE MOST CRITICAL FAILURE THROUGH THE SOIL NAIL WALLS
	Drawn By	R. ZWEIGLER	Scale	Company	BYER GEOTECHNICAL, INC.
	Date	5/18/2015		File Name	21898 Section 3 ver4 active wedge.slim

Valid / Invalid Surfaces

Method: janbu corrected

Number of Valid Surfaces: 1

Number of Invalid Surfaces: 0

Slice Data

Global Minimum Query (janbu corrected) - Safety Factor: 0.9796

Slice Number	Width [ft]	Weight [lbs]	Base Material	Base Cohesion [psf]	Base Friction Angle [degrees]	Shear Stress [psf]	Shear Strength [psf]	Base Normal Stress [psf]	Pore Pressure [psf]	Effective Normal Stress [psf]
1	1.55089	294.099	Fill	400	30	268.902	263.416	-236.57	0	-236.57
2	1.55089	882.298	Fill	400	30	384.472	376.629	-40.4804	0	-40.4804
3	1.55089	1470.5	Fill	400	30	500.042	489.841	155.609	0	155.609
4	1.60411	2118.03	Fill	400	30	613.464	600.949	348.055	0	348.055
5	1.60411	2609.9	Fill	400	30	706.901	692.48	506.588	0	506.588
6	1.62964	3137.69	Fill	400	30	797.826	781.55	660.863	0	660.863
7	1.62964	3627.79	Fill	400	30	889.468	871.323	816.354	0	816.354
8	1.62964	4117.89	Fill	400	30	981.111	961.096	971.846	0	971.846
9	1.62964	4607.99	Fill	400	30	1072.75	1050.87	1127.34	0	1127.34
10	1.62964	5098.09	Fill	400	30	1164.39	1140.64	1282.83	0	1282.83
11	1.62964	5020.56	Fill	400	30	1149.9	1126.44	1258.23	0	1258.23
12	2.4215	4680.65	Fill	400	30	933.65	914.604	891.322	0	891.322
13	1.60281	1805.8	Fill	400	30	690.937	676.842	479.503	0	479.503
14	1.60281	2045.54	Fill	400	30	747.738	732.484	575.878	0	575.878
15	1.60281	2325.7	Fill	400	30	814.115	797.507	688.502	0	688.502
16	1.60281	2605.86	Fill	400	30	880.492	862.53	801.125	0	801.125
17	1.60281	2886.02	Fill	400	30	946.869	927.553	913.748	0	913.748
18	1.60281	3166.18	Fill	400	30	1013.25	992.576	1026.37	0	1026.37
19	1.56396	3359.48	Fill	400	30	1078.82	1056.81	1137.63	0	1137.63
20	1.56396	3626.22	Fill	400	30	1143.59	1120.26	1247.53	0	1247.53
21	1.56396	3892.97	Fill	400	30	1208.36	1183.7	1357.41	0	1357.41
22	1.56396	4159.71	Fill	400	30	1273.12	1247.15	1467.31	0	1467.31
23	1.56396	4422.1	Fill	400	30	1336.84	1309.56	1575.41	0	1575.41
24	1.56396	3272.53	Fill	400	30	1057.71	1036.13	1101.81	0	1101.81
25	1.34458	917.329	Fill	400	30	718.743	704.081	526.684	0	526.684

Interslice Data

Global Minimum Query (janbu corrected) - Safety Factor: 0.9796

Slice	X coordinate	Y coordinate	Interslice Bottom	Interslice Normal Force	Interslice Shear Force	Interslice Force Angle
 BYER GEOTECHNICAL INC.						
Project: BG 21898 HARVARD WESTLAKE SECTION 3						
Analysis Description: CALCULATE THE LOCATION OF THE MOST CRITICAL FAILURE THROUGH THE SOIL NAIL WALLS						
Drawn By: R. ZWEIGLER			Scale:		Company: BYER GEOTECHNICAL, INC.	
Date: 5/18/2015			File Name: 21898 Section 3 ver4 active wedge.slim			
SLIDEINTERPRET 6.035						

	[ft]	[ft]	[lbs]	[lbs]	[degrees]
1	93.5946	764.297	0	0	0
2	95.1454	761.912	-994.049	0	0
3	96.6963	759.527	-1705.13	0	0
4	98.2472	757.142	-2133.25	0	0
5	99.8513	754.675	-2288.82	0	0
6	101.455	752.208	-2207.77	0	0
7	103.085	749.702	-1891.51	0	0
8	104.715	747.196	-1339.47	0	0
9	106.344	744.69	-551.657	0	0
10	107.974	742.183	471.926	0	0
11	109.604	739.677	1731.28	0	0
12	111.233	737.171	2953.34	0	0
13	113.655	734.55	2959.68	0	0
14	115.258	733.093	2516.78	0	0
15	116.86	731.637	2120.42	0	0
16	118.463	730.18	1778.46	0	0
17	120.066	728.723	1490.91	0	0
18	121.669	727.267	1257.75	0	0
19	123.272	725.81	1078.99	0	0
20	124.836	724.389	957.008	0	0
21	126.4	722.968	886.815	0	0
22	127.964	721.546	868.417	0	0
23	129.527	720.125	901.812	0	0
24	131.091	718.704	986.158	0	0
25	132.655	717.282	847.287	0	0
26	134	717	0	0	0

List Of Coordinates

External Boundary

X	Y
79	757
62	760
28	765
18	767
3	770
0	771
-16	774
-20	775
-36	780
-64	788
-64	630

 BYER GEOTECHNICAL INC.	Project			BG 21898 HARVARD WESTLAKE SECTION 3		
	Analysis Description					CALCULATE THE LOCATION OF THE MOST CRITICAL FAILURE THROUGH THE SOIL NAIL WALLS
	Drawn By	R. ZWEIGLER	Scale	Company		BYER GEOTECHNICAL, INC.
	Date	5/18/2015		File Name	21898 Section 3 ver4 active wedge.slim	

0	630
405	630
405	680
405	709.045
405	713
372	713
368	715
328	720
210	720
134	717
131	743
114	743
112.449	751.767
110	767
99	767

Material Boundary

X	Y
117	717
134	714.875
285	696
323	690
405	680

Material Boundary

X	Y
79	757
94	755
112.449	751.767

Material Boundary

X	Y
-16	774
8.75649	759.641
34	745
117	717
134	717

Material Boundary

X	Y
134	714.875

 <p>BYER GEOTECHNICAL INC.</p>	<i>Project</i> BG 21898 HARVARD WESTLAKE SECTION 3		
	<i>Analysis Description</i> CALCULATE THE LOCATION OF THE MOST CRITICAL FAILURE THROUGH THE SOIL NAIL WALLS		
	<i>Drawn By</i> R. ZWEIGLER	<i>Scale</i>	<i>Company</i> BYER GEOTECHNICAL, INC.
	<i>Date</i> 5/18/2015		<i>File Name</i> 21898 Section 3 ver4 active wedge.slim

 BYER GEOTECHNICAL INC.	<i>Project</i>		
	BG 21898 HARVARD WESTLAKE SECTION 3		
	<i>Analysis Description</i>		
	CALCULATE THE LOCATION OF THE MOST CRITICAL FAILURE THROUGH THE SOIL NAIL WALLS		
<i>Drawn By</i>	R. ZWEIGLER	<i>Scale</i>	<i>Company</i>
			BYER GEOTECHNICAL, INC.
<i>Date</i>	5/18/2015		<i>File Name</i>
			21898 Section 3 ver4 active wedge.slim
SLIDEINTERPRET 6.035			

BG 21898 HARVARD WESTLAKE SECTION 3

CALCULATE THE MINIMUM REQUIRED EFP TO GENERATE A FACTOR OF SAFETY OF 1.5, APPLIED SO AS TO REPRESENT THE MASS OF EARTH CONSISTING OF A SOIL NAIL RETAINING WALL.

THE RESULTS INDICATE THAT AN EFP OF 21 PCF WILL ACHIEVE A FACTOR OF SAFETY OF GREATER THAN 1.5.

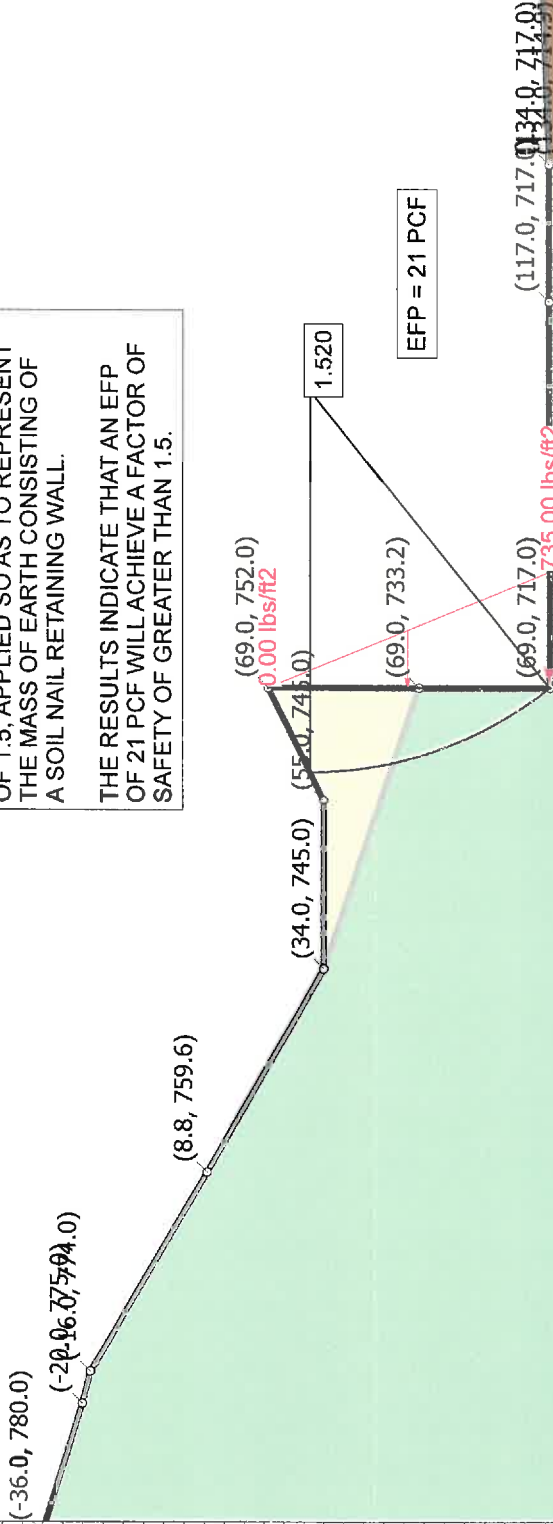

Material Name	Color	Unit Weight (lbs/ft ³)	Strength Type	Cohesion (psf)	Phi (deg)
Fill		120	Mohr-Coulomb	400	30
Bedrock		115	Mohr-Coulomb	540	36
Alluvium		110	Mohr-Coulomb	150	30

BYER GEOTECHNICAL INC.

BG 21898 HARVARD WESTLAKE SECTION 3

ANALYSIS DESCRIPTION: CALCULATE THE MINIMUM REQUIRED EFP TO REPRESENT SOIL NAIL EARTH BLOCK

DRAWN BY: R. ZWEIGLER SCALE: 1:288 COMPANY: BYER GEOTECHNICAL, INC.

DATE: 5/18/2015 FILE NAME: 21898 Section 3 efp on back of soil nail wall VER2.slm

SLIDE/INTERPRET 6.035

Slide Analysis Information

BG 21898 HARVARD WESTLAKE SECTION 3

Project Summary

File Name: 21898 Section 3 efp on back of soil nail wall VER2
Slide Modeler Version: 6.035
Project Title: BG 21898 HARVARD WESTLAKE SECTION 3
Analysis: CALCULATE THE MINIMUM REQUIRED EFP TO REPRESENT SOIL NAIL EARTH BLOCK
Author: R. ZWEIGLER
Company: BYER GEOTECHNICAL, INC.
Date Created: 5/18/2015

General Settings

Units of Measurement: Imperial Units
Time Units: days
Permeability Units: feet/second
Failure Direction: Left to Right
Data Output: Standard
Maximum Material Properties: 20
Maximum Support Properties: 20

Analysis Options

Analysis Methods Used

Bishop simplified

Number of slices: 25
Tolerance: 0.005
Maximum number of iterations: 50
Check $m\alpha < 0.2$: Yes
Initial trial value of FS: 1
Steffensen Iteration: Yes

Groundwater Analysis

Groundwater Method: Water Surfaces
Pore Fluid Unit Weight: 62.4 lbs/ft³
Advanced Groundwater Method: None

Random Numbers

 BYER GEOTECHNICAL INC.	<i>Project</i> BG 21898 HARVARD WESTLAKE SECTION 3		
	<i>Analysis Description</i> CALCULATE THE MINIMUM REQUIRED EFP TO REPRESENT SOIL NAIL EARTH BLOCK		
	<i>Drawn By</i> R. ZWEIGLER	<i>Scale</i>	<i>Company</i> BYER GEOTECHNICAL, INC.
	<i>Date</i> 5/18/2015	<i>File Name</i> 21898 Section 3 efp on back of soil nail wall VER2 slim	

Surface Options

Surface Type: Circular
 Search Method: Auto Refine Search
 Divisions along slope: 25
 Circles per division: 10
 Number of iterations: 10
 Divisions to use in next iteration: 50%
 Composite Surfaces: Disabled
 Minimum Elevation: Not Defined
 Minimum Depth: Not Defined



Loading

1 Distributed Load present

Distributed Load 1

Distribution: Triangular
 Magnitude 1 [psf]: 735
 Magnitude 2 [psf]: 0
 Orientation: Horizontal

Material Properties

Property	Fill	Bedrock	Alluvium
Color			
Strength Type	Mohr-Coulomb	Mohr-Coulomb	Mohr-Coulomb
Unit Weight [lbs/ft3]	120	115	110
Cohesion [psf]	400	540	150
Friction Angle [deg]	30	36	30
Water Surface	None	None	None
Ru Value	0	0	0

Global Minimums

Method: bishop simplified

FS: 1.520050
 Center: 105.917, 746.758
 Radius: 47.402
 Left Slip Surface Endpoint: 58.515, 746.758

 BYER GEOTECHNICAL INC.	Project			BG 21898 HARVARD WESTLAKE SECTION 3		
	Analysis Description					CALCULATE THE MINIMUM REQUIRED EFP TO REPRESENT SOIL NAIL EARTH BLOCK
	Drawn By	R. ZWEIGLER	Scale	Company	BYER GEOTECHNICAL, INC.	
	Date	5/18/2015		File Name	21898 Section 3 erp on back of soil nail wall VER2 slim	

Right Slip Surface Endpoint: 69.000, 717.025
 Left Slope Intercept: 58.515 746.758
 Right Slope Intercept: 69.000 752.000
 Resisting Moment=1.41538e+006 lb-ft
 Driving Moment=931136 lb-ft
 Total Slice Area=239.903 ft²

Valid / Invalid Surfaces

Method: bishop simplified

Number of Valid Surfaces: 14725
 Number of Invalid Surfaces: 0

Slice Data

Global Minimum Query (bishop simplified) - Safety Factor: 1.52005

Slice Number	Width [ft]	Weight [lbs]	Base Material	Base Cohesion [psf]	Base Friction Angle [degrees]	Shear Stress [psf]	Shear Strength [psf]	Base Normal Stress [psf]	Pore Pressure [psf]	Effective Normal Stress [psf]
1	0.387959	145.396	Fill	400	30	58.575	89.037	-538.603	0	-538.603
2	0.387959	353.252	Fill	400	30	177.238	269.41	-226.188	0	-226.188
3	0.387959	464.41	Fill	400	30	251.211	381.854	-31.4298	0	-31.4298
4	0.423665	607.897	Bedrock	540	36	353.435	537.239	-3.8006	0	-3.8006
5	0.423665	697.447	Bedrock	540	36	425.012	646.04	145.951	0	145.951
6	0.423665	777.509	Bedrock	540	36	491.719	747.437	285.512	0	285.512
7	0.423665	850.724	Bedrock	540	36	554.801	843.325	417.491	0	417.491
8	0.423665	918.678	Bedrock	540	36	615.026	934.871	543.493	0	543.493
9	0.423665	982.414	Bedrock	540	36	672.912	1022.86	664.599	0	664.599
10	0.423665	1042.66	Bedrock	540	36	728.829	1107.86	781.587	0	781.587
11	0.423665	1099.96	Bedrock	540	36	783.054	1190.28	895.035	0	895.035
12	0.423665	1154.72	Bedrock	540	36	835.802	1270.46	1005.39	0	1005.39
13	0.423665	1207.25	Bedrock	540	36	887.244	1348.66	1113.02	0	1113.02
14	0.423665	1257.81	Bedrock	540	36	937.52	1425.08	1218.2	0	1218.2
15	0.423665	1306.61	Bedrock	540	36	986.742	1499.9	1321.19	0	1321.19
16	0.423665	1353.83	Bedrock	540	36	1035.01	1573.26	1422.16	0	1422.16
17	0.423665	1399.59	Bedrock	540	36	1082.4	1645.3	1521.32	0	1521.32
18	0.423665	1444.03	Bedrock	540	36	1128.98	1716.11	1618.78	0	1618.78
19	0.423665	1487.26	Bedrock	540	36	1174.82	1785.79	1714.68	0	1714.68
20	0.423665	1529.35	Bedrock	540	36	1219.97	1854.42	1809.14	0	1809.14
21	0.423665	1570.4	Bedrock	540	36	1264.48	1922.07	1902.26	0	1902.26
22	0.423665	1610.47	Bedrock	540	36	1308.38	1988.8	1994.11	0	1994.11
23	0.423665	1649.62	Bedrock	540	36	1351.72	2054.68	2084.77	0	2084.77
24	0.423665	1687.91	Bedrock	540	36	1394.52	2119.74	2174.34	0	2174.34
25	0.423665	1725.39	Bedrock	540	36	1436.83	2184.05	2262.84	0	2262.84

 BYER GEOTECHNICAL INC.	Project			BG 21898 HARVARD WESTLAKE SECTION 3													
	Analysis Description						CALCULATE THE MINIMUM REQUIRED EFP TO REPRESENT SOIL NAIL EARTH BLOCK										
	Drawn By			R. ZWEIGLER			Scale			Company			BYER GEOTECHNICAL, INC.				
	Date						5/18/2015						File Name			BG 21898 Section 3 erp on back of soil nail wall VER2 slim	

Interslice Data

Global Minimum Query (bishop simplified) - Safety Factor: 1.52005

Slice Number	X coordinate [ft]	Y coordinate - Bottom [ft]	Interslice Normal Force [lbs]	Interslice Shear Force [lbs]	Interslice Force Angle [degrees]
1	58.5155	746.758	0	0	0
2	58.9035	740.706	-3282.46	0	0
3	59.2914	738.216	-3914.24	0	0
4	59.6794	736.318	-4071.31	0	0
5	60.103	734.593	-4227.54	0	0
6	60.5267	733.097	-4189.16	0	0
7	60.9504	731.761	-4016	0	0
8	61.374	730.546	-3743.65	0	0
9	61.7977	729.426	-3395.48	0	0
10	62.2214	728.384	-2987.95	0	0
11	62.645	727.407	-2533.22	0	0
12	63.0687	726.486	-2040.62	0	0
13	63.4924	725.614	-1517.53	0	0
14	63.916	724.785	-969.935	0	0
15	64.3397	723.993	-402.765	0	0
16	64.7634	723.236	179.832	0	0
17	65.187	722.51	774.326	0	0
18	65.6107	721.812	1377.67	0	0
19	66.0343	721.14	1987.21	0	0
20	66.458	720.492	2600.6	0	0
21	66.8817	719.866	3215.78	0	0
22	67.3053	719.261	3830.88	0	0
23	67.729	718.676	4444.23	0	0
24	68.1527	718.109	5054.33	0	0
25	68.5763	717.559	5659.78	0	0
26	69	717.025	12844.2	0	0

List Of Coordinates

Distributed Load

X	Y
69	717
69	733.167
69	752

 BYER GEOTECHNICAL INC.	Project			BG 21898 HARVARD WESTLAKE SECTION 3		
	Analysis Description					CALCULATE THE MINIMUM REQUIRED EFP TO REPRESENT SOIL NAIL EARTH BLOCK
	Drawn By	R. ZWEIGLER	Scale	Company		BYER GEOTECHNICAL, INC.
	Date	5/18/2015		File Name	BG 21898 Section 3 erp on back of soil nail wall VER2 slim	

External Boundary

X	Y
117	717
69	717
69	733.167
69	752
55	745
34	745
8.75649	759.641
-16	774
-20	775
-36	780
-64	788
-64	630
0	630
405	630
405	680
405	709.045
405	713
372	713
368	715
328	720
210	720
134	717

Material Boundary

X	Y
117	717
134	714.875
285	696
323	690
405	680

Material Boundary

X	Y
34	745
69	733.167

Material Boundary

X	Y
134	714.875

 <p>BYER GEOTECHNICAL INC.</p>	<i>Project</i> BG 21898 HARVARD WESTLAKE SECTION 3		
	<i>Analysis Description</i> CALCULATE THE MINIMUM REQUIRED EFP TO REPRESENT SOIL NAIL EARTH BLOCK		
	<i>Drawn By</i> R. ZWEIGLER	<i>Scale</i>	<i>Company</i> BYER GEOTECHNICAL, INC.
	<i>Date</i> 5/18/2015		<i>File Name</i> BG 21898 Section 3 erp on back of soil nail wall VER2 slim
<small>SLIDEINTERPRET 6.035</small>			

 <p>BYER GEOTECHNICAL INC.</p>	<i>Project</i>		
	BG 21898 HARVARD WESTLAKE SECTION 3		
	<i>Analysis Description</i>		
	CALCULATE THE MINIMUM REQUIRED EFP TO REPRESENT SOIL NAIL EARTH BLOCK		
<i>Drawn By</i>	R. ZWEIGLER	<i>Scale</i>	<i>Company</i>
			BYER GEOTECHNICAL, INC.
<i>Date</i>	5/18/2015	<i>File Name</i>	21898 Section 3 etp on back of soil nail wall VER2 slim
SLIDEINTERPRET 6.035			

BG 21898 HARVARD WESTLAKE
SECTION 3

CALCULATE THE MINIMUM REQUIRED EFP TO GENERATE A FACTOR OF SAFETY OF 1.0 UNDER SEISMIC LOADING, APPLIED SO AS TO REPRESENT THE MASS OF EARTH CONSISTING OF A SOIL NAIL RETAINING WALL.

THE RESULTS INDICATE THAT AN EFP OF 21 PCF WILL ACHIEVE A FACTOR OF SAFETY OF GREATER THAN 1.0 UNDER SEISMIC LOADING.

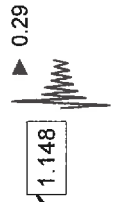

EFP = 30 PCF

EFP = 21 PCF

0.00 lbs/ft²

735.00 lbs/ft²

Material Name	Color	Unit Weight (lbs/ft ³)	Strength Type	Cohesion (psf)	Phi (deg)
Fill		120	Mohr-Coulomb	400	30
Bedrock		115	Mohr-Coulomb	540	36
Alluvium		110	Mohr-Coulomb	150	30

BG 21898 HARVARD WESTLAKE SECTION 3

ANALYSIS DESCRIPTION: CALCULATE THE MINIMUM REQUIRED EFP TO REPRESENT SOIL NAIL EARTH BLOCK (SEISMIC)

DRAWN BY: R. ZWEIGLER
SCALE: 1:489
COMPANY: BYER GEOTECHNICAL, INC.

DATE: 5/18/2015
FILE NAME: 21898 Section 3 efp on back of soil nail wall EQ.slim



Slide Analysis Information

BG 21898 HARVARD WESTLAKE SECTION 3

Project Summary

File Name: 21898 Section 3 efp on back of soil nail wall EQ
Slide Modeler Version: 6.035
Project Title: BG 21898 HARVARD WESTLAKE SECTION 3
Analysis: CALCULATE THE MINIMUM REQUIRED EFP TO REPRESENT SOIL NAIL EARTH BLOCK (SEISMIC)
Author: R. ZWEIGLER
Company: BYER GEOTECHNICAL, INC.
Date Created: 5/18/2015

General Settings

Units of Measurement: Imperial Units
Time Units: days
Permeability Units: feet/second
Failure Direction: Left to Right
Data Output: Standard
Maximum Material Properties: 20
Maximum Support Properties: 20

Analysis Options

Analysis Methods Used

Bishop simplified

Number of slices: 25
Tolerance: 0.005
Maximum number of iterations: 50
Check malpha < 0.2: Yes
Initial trial value of FS: 1
Steffensen Iteration: Yes

Groundwater Analysis

Groundwater Method: Water Surfaces
Pore Fluid Unit Weight: 62.4 lbs/ft³
Advanced Groundwater Method: None

Random Numbers

 BYER GEOTECHNICAL INC.	<i>Project</i> BG 21898 HARVARD WESTLAKE SECTION 3		
	<i>Analysis Description</i> CALCULATE THE MINIMUM REQUIRED EFP TO REPRESENT SOIL NAIL EARTH BLOCK (SEISMIC)		
	<i>Drawn By</i> R. ZWEIGLER	<i>Scale</i>	<i>Company</i> BYER GEOTECHNICAL, INC.
	<i>Date</i> 5/18/2015	<i>File Name</i> 21898 Section 3 efp on back of soil nail wall EQ slim	

SLIDEINTERPRET 6.035

Surface Options

Surface Type: Circular
 Search Method: Auto Refine Search
 Divisions along slope: 25
 Circles per division: 10
 Number of iterations: 10
 Divisions to use in next iteration: 50%
 Composite Surfaces: Disabled
 Minimum Elevation: Not Defined
 Minimum Depth: Not Defined



Loading

Seismic Load Coefficient (Horizontal): 0.29
 1 Distributed Load present

Distributed Load 1

Distribution: Triangular
 Magnitude 1 [psf]: 735
 Magnitude 2 [psf]: 0
 Orientation: Horizontal

Material Properties

Property	Fill	Bedrock	Alluvium
Color			
Strength Type	Mohr-Coulomb	Mohr-Coulomb	Mohr-Coulomb
Unit Weight [lbs/ft ³]	120	115	110
Cohesion [psf]	400	540	150
Friction Angle [deg]	30	36	30
Water Surface	None	None	None
Ru Value	0	0	0

Global Minimums

Method: bishop simplified

FS: 1.147750
 Center: 307.490, 887.865
 Radius: 293.374

 <p>BYER GEOTECHNICAL INC.</p>	Project BG 21898 HARVARD WESTLAKE SECTION 3		
	Analysis Description CALCULATE THE MINIMUM REQUIRED EFP TO REPRESENT SOIL NAIL EARTH BLOCK (SEISMIC)		
	Drawn By R. ZWEIGLER	Scale	Company BYER GEOTECHNICAL, INC.
	Date 5/18/2015		File Name BG 21898 Section 3 erp on back of soil nail wall EQ slim

Left Slip Surface Endpoint: 51.252, 745.000
 Right Slip Surface Endpoint: 69.000, 717.011
 Left Slope Intercept: 51.252 745.000
 Right Slope Intercept: 69.000 752.000
 Resisting Moment=9.66618e+006 lb-ft
 Driving Moment=8.42188e+006 lb-ft
 Total Slice Area=307.706 ft2

Valid / Invalid Surfaces

Method: bishop simplified

Number of Valid Surfaces: 7153
 Number of Invalid Surfaces: 0

Slice Data

Global Minimum Query (bishop simplified) - Safety Factor: 1.14775

Slice Number	Width [ft]	Weight [lbs]	Base Material	Base Cohesion [psf]	Base Friction Angle [degrees]	Shear Stress [psf]	Shear Strength [psf]	Base Normal Stress [psf]	Pore Pressure [psf]	Effective Normal Stress [psf]
1	0.695907	51.8202	Fill	400	30	203.697	233.793	-287.878	0	-287.878
2	0.695907	154.879	Fill	400	30	244.308	280.404	-207.147	0	-207.147
3	0.695907	256.789	Fill	400	30	284.871	326.961	-126.507	0	-126.507
4	0.695907	357.579	Fill	400	30	325.385	373.461	-45.9671	0	-45.9671
5	0.695907	457.276	Fill	400	30	365.845	419.899	34.4652	0	34.4652
6	0.695907	561.384	Fill	400	30	408.39	468.73	119.044	0	119.044
7	0.714354	704.056	Bedrock	540	36	532.66	611.36	98.219	0	98.219
8	0.714354	833.03	Bedrock	540	36	591.514	678.91	191.193	0	191.193
9	0.714354	960.974	Bedrock	540	36	650.486	746.595	284.353	0	284.353
10	0.714354	1087.91	Bedrock	540	36	709.567	814.406	377.688	0	377.688
11	0.714354	1213.87	Bedrock	540	36	768.755	882.338	471.188	0	471.188
12	0.714354	1338.86	Bedrock	540	36	828.04	950.383	564.844	0	564.844
13	0.714354	1462.91	Bedrock	540	36	887.418	1018.53	658.645	0	658.645
14	0.714354	1586.04	Bedrock	540	36	946.883	1086.78	752.585	0	752.585
15	0.714354	1708.27	Bedrock	540	36	1006.43	1155.13	846.659	0	846.659
16	0.714354	1829.61	Bedrock	540	36	1066.06	1223.57	940.845	0	940.845
17	0.714354	1950.09	Bedrock	540	36	1125.75	1292.08	1035.15	0	1035.15
18	0.714354	2069.72	Bedrock	540	36	1185.52	1360.68	1129.57	0	1129.57
19	0.714354	2188.52	Bedrock	540	36	1245.35	1429.35	1224.09	0	1224.09
20	0.714354	2306.51	Bedrock	540	36	1305.24	1498.09	1318.7	0	1318.7
21	0.714354	2423.69	Bedrock	540	36	1365.18	1566.89	1413.4	0	1413.4
22	0.714354	2540.09	Bedrock	540	36	1425.19	1635.76	1508.18	0	1508.18
23	0.714354	2655.72	Bedrock	540	36	1485.24	1704.68	1603.05	0	1603.05
24	0.714354	2770.59	Bedrock	540	36	1545.33	1773.65	1697.98	0	1697.98

 BYER GEOTECHNICAL INC.	Project			BG 21898 HARVARD WESTLAKE SECTION 3								
	Analysis Description						CALCULATE THE MINIMUM REQUIRED EFP TO REPRESENT SOIL NAIL EARTH BLOCK (SEISMIC)					
	Drawn By		R. ZWEIGLER		Scale		Company		BYER GEOTECHNICAL, INC.			
	Date		5/18/2015				File Name		21898 Section 3 erp on back of soil nail wall EQ slim			

Interslice Data

Global Minimum Query (bishop simplified) - Safety Factor: 1.14775

Slice Number	X coordinate [ft]	Y coordinate - Bottom [ft]	Interslice Normal Force [lbs]	Interslice Shear Force [lbs]	Interslice Force Angle [degrees]
1	51.2518	745	0	0	0
2	51.9477	743.759	-483.642	0	0
3	52.6436	742.532	-862.507	0	0
4	53.3395	741.318	-1139.3	0	0
5	54.0355	740.118	-1316.64	0	0
6	54.7314	738.931	-1397.05	0	0
7	55.4273	737.756	-1377.87	0	0
8	56.1416	736.563	-1436.05	0	0
9	56.856	735.382	-1390.25	0	0
10	57.5703	734.214	-1242.93	0	0
11	58.2847	733.058	-996.444	0	0
12	58.999	731.914	-653.107	0	0
13	59.7134	730.782	-215.157	0	0
14	60.4277	729.661	315.226	0	0
15	61.1421	728.55	935.92	0	0
16	61.8565	727.451	1644.86	0	0
17	62.5708	726.363	2440.03	0	0
18	63.2852	725.285	3319.46	0	0
19	63.9995	724.217	4281.26	0	0
20	64.7139	723.159	5323.54	0	0
21	65.4282	722.111	6444.49	0	0
22	66.1426	721.072	7642.33	0	0
23	66.8569	720.043	8915.33	0	0
24	67.5713	719.024	10261.8	0	0
25	68.2856	718.013	11680	0	0
26	69	717.011	12854.1	0	0

List Of Coordinates

Distributed Load

X	Y
69	717
69	733.167
69	752

 <p>BYER GEOTECHNICAL INC.</p>	Project			BG 21898 HARVARD WESTLAKE SECTION 3		
	Analysis Description					CALCULATE THE MINIMUM REQUIRED EFP TO REPRESENT SOIL NAIL EARTH BLOCK (SEISMIC)
	Drawn By		R. ZWEIGLER	Scale	Company	
	Date		5/18/2015		File Name	
					BYER GEOTECHNICAL, INC.	
					21898 Section 3 erp on back of soil nail wall	
					EQ slim	

External Boundary

X	Y
117	717
69	717
69	733.167
69	752
55	745
34	745
8.75649	759.641
-16	774
-20	775
-36	780
-64	788
-64	630
0	630
405	630
405	680
405	709.045
405	713
372	713
368	715
328	720
210	720
134	717

Material Boundary

X	Y
117	717
134	714.875
285	696
323	690
405	680

Material Boundary

X	Y
34	745
69	733.167

Material Boundary

X	Y
134	714.875

 <p>BYER GEOTECHNICAL INC.</p>	<i>Project</i> BG 21898 HARVARD WESTLAKE SECTION 3		
	<i>Analysis Description</i> CALCULATE THE MINIMUM REQUIRED EFP TO REPRESENT SOIL NAIL EARTH BLOCK (SEISMIC)		
	<i>Drawn By</i> R. ZWEIGLER	<i>Scale</i>	<i>Company</i> BYER GEOTECHNICAL, INC.
	<i>Date</i> 5/18/2015		<i>File Name</i> BG 21898 Section 3 erp on back of soil nail wall EQ slim
<small>SLIDEINTERPRET 6.035</small>			

 <p>BYER GEOTECHNICAL INC.</p>	<i>Project</i>		
	BG 21898 HARVARD WESTLAKE SECTION 3		
	<i>Analysis Description</i>		
	CALCULATE THE MINIMUM REQUIRED EFP TO REPRESENT SOIL NAIL EARTH BLOCK (SEISMIC)		
<i>Drawn By</i>	R. ZWEIGLER	<i>Scale</i>	<i>Company</i>
			BYER GEOTECHNICAL, INC.
<i>Date</i>	5/18/2015		<i>File Name</i>
			BG 21898 Section 3 efp on back of soil nail wall EQ.slm
SLIDEINTERPRET 6.035			

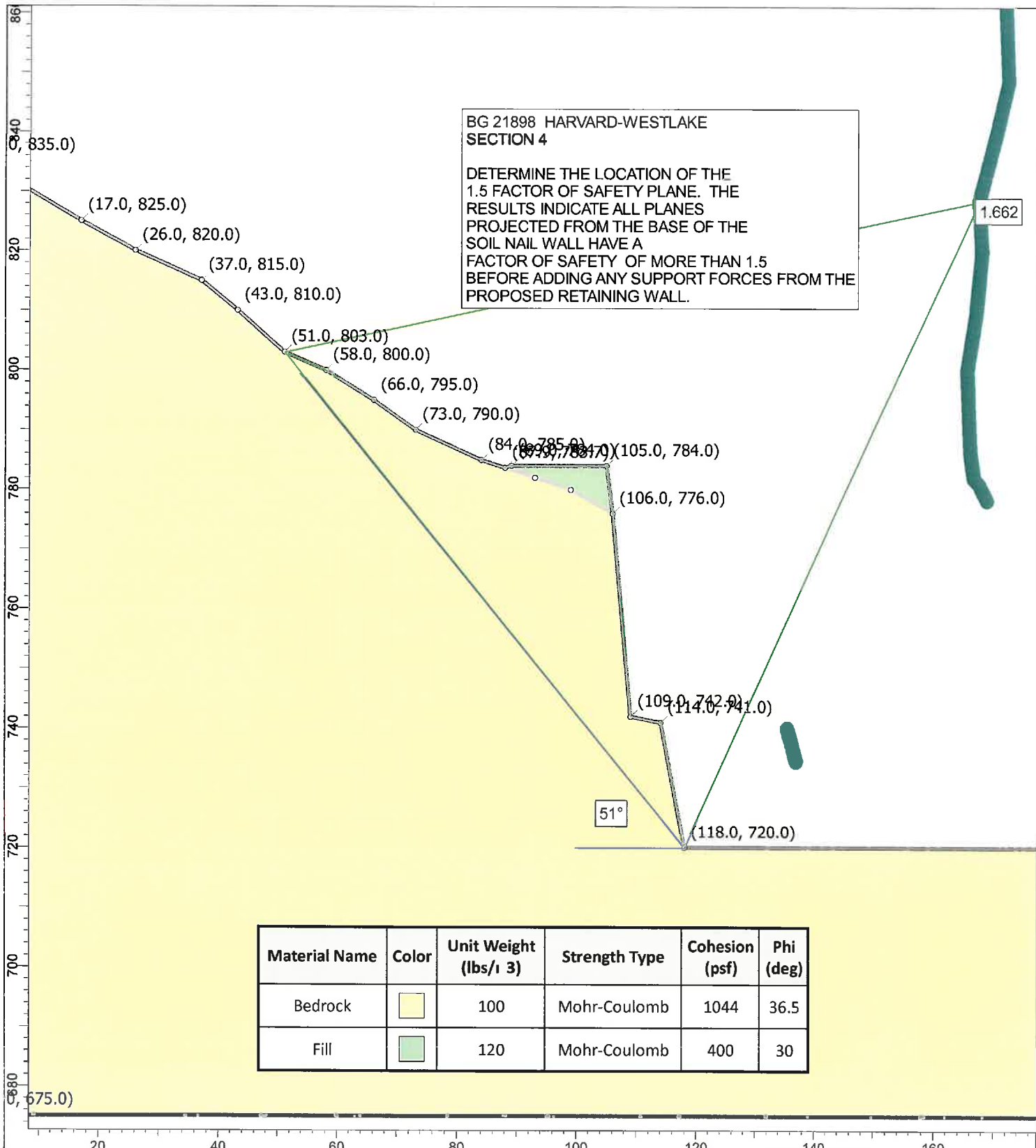

BG 21898 HARVARD-WESTLAKE SECTION 4

DETERMINE THE LOCATION OF THE 1.5 FACTOR OF SAFETY PLANE. THE RESULTS INDICATE ALL PLANES PROJECTED FROM THE BASE OF THE SOIL NAIL WALL HAVE A FACTOR OF SAFETY OF MORE THAN 1.5 BEFORE ADDING ANY SUPPORT FORCES FROM THE PROPOSED RETAINING WALL.

Material Name	Color	Unit Weight (lbs/ft ³)	Strength Type	Cohesion (psf)	Phi (deg)
Bedrock		100	Mohr-Coulomb	1044	36.5
Fill		120	Mohr-Coulomb	400	30

 BYER GEOTECHNICAL INC.	<i>Project</i> BG 21898 HARVARD-WESTLAKE SECTION 4			
	<i>Analysis Description</i> CALCULATE THE LOCATION OF THE 1.5 FACTOR OF SAFETY PLANE			
	<i>Drawn By</i> R. ZWEIGLER	<i>Scale</i> 1:260	<i>Company</i> BYER GEOTECHNICAL, INC.	
	<i>Date</i> 1/23/2014, 12:05:01 PM		<i>File Name</i> 21898 Section 4.slm	

Slide Analysis Information

BG 21898 HARVARD-WESTLAKE SECTION 4

Project Summary

File Name: 21898 Section 4
Slide Modeler Version: 6.033
Project Title: BG 21898 HARVARD-WESTLAKE SECTION 4
Analysis: CALCULATE THE LOCATION OF THE 1.5 FACTOR OF SAFETY PLANE
Author: R. ZWEIGLER
Company: BYER GEOTECHNICAL, INC.
Date Created: 1/23/2014, 12:05:01 PM

General Settings

Units of Measurement: Imperial Units
Time Units: days
Permeability Units: feet/second
Failure Direction: Left to Right
Data Output: Standard
Maximum Material Properties: 20
Maximum Support Properties: 20

Analysis Options

Analysis Methods Used

Janbu corrected

Number of slices: 25
Tolerance: 0.005
Maximum number of iterations: 50
Check malpha < 0.2: Yes
Initial trial value of FS: 1
Steffensen Iteration: Yes

Groundwater Analysis

Groundwater Method: Water Surfaces
Pore Fluid Unit Weight: 62.4 lbs/ft³
Advanced Groundwater Method: None

 BYER GEOTECHNICAL INC.	<i>Project</i> BG 21898 HARVARD-WESTLAKE SECTION 4			
	<i>Analysis Description</i> CALCULATE THE LOCATION OF THE 1.5 FACTOR OF SAFETY PLANE			
	<i>Drawn By</i> R. ZWEIGLER	<i>Scale</i>	<i>Company</i> BYER GEOTECHNICAL, INC.	
	<i>Date</i> 1/23/2014, 12:05:01 PM		<i>File Name</i> 21898 Section 4.slim	

Random Numbers

Pseudo-random Seed: 10116

Random Number Generation Method: Park and Miller v.3

Surface Options

Surface Type: Non-Circular Block Search

Number of Surfaces: 5000

Pseudo-Random Surfaces: Enabled

Convex Surfaces Only: Disabled

Left Projection Angle (Start Angle): 95

Left Projection Angle (End Angle): 220



Right Projection Angle (Start Angle): -85

Right Projection Angle (End Angle): 85

Minimum Elevation: Not Defined

Minimum Depth: Not Defined

Material Properties

Property	Bedrock	Fill
Color		
Strength Type	Mohr-Coulomb	Mohr-Coulomb
Unit Weight [lbs/ft3]	100	120
Cohesion [psf]	1044	400
Friction Angle [deg]	36.5	30
Water Surface	None	None
Ru Value	0	0

Global Minimums

Method: janbu corrected

FS: 1.662150

Axis Location: 167.502, 828.462

Left Slip Surface Endpoint: 51.032, 802.986

Right Slip Surface Endpoint: 118.000, 720.000

Resisting Horizontal Force=109115 lb

Driving Horizontal Force=65647 lb

Total Slice Area=1330.83 ft²

Global Minimum Coordinates

 BYER GEOTECHNICAL INC.	<i>Project</i> BG 21898 HARVARD-WESTLAKE SECTION 4		
	<i>Analysis Description</i> CALCULATE THE LOCATION OF THE 1.5 FACTOR OF SAFETY PLANE		
	<i>Drawn By</i> R. ZWEIGLER	<i>Scale</i>	<i>Company</i> BYER GEOTECHNICAL, INC.
	<i>Date</i> 1/23/2014, 12:05:01 PM	<i>File Name</i> 21898 Section 4.slim	

Method: janbu corrected

X	Y
51.0316	802.986
118	720

Valid / Invalid Surfaces

Method: janbu corrected

Number of Valid Surfaces: 2008
Number of Invalid Surfaces: 2992

Error Codes:

Error Code -105 reported for 39 surfaces
Error Code -107 reported for 84 surfaces
Error Code -108 reported for 2869 surfaces

Error Codes

The following errors were encountered during the computation:

- 105 = More than two surface / slope intersections with no valid slip surface.
- 107 = Total driving moment or total driving force is negative. This will occur if the wrong failure direction is specified, or if high external or anchor loads are applied against the failure direction.
- 108 = Total driving moment or total driving force < 0.1. This is to limit the calculation of extremely high safety factors if the driving force is very small (0.1 is an arbitrary number).

Slice Data

Global Minimum Query (janbu corrected) - Safety Factor: 1.66215

Slice Number	Width [ft]	Weight [lbs]	Base Material	Base Cohesion [psf]	Base Friction Angle [degrees]	Shear Stress [psf]	Shear Strength [psf]	Base Normal Stress [psf]	Pore Pressure [psf]	Effective Normal Stress [psf]
1	2.67874	290.834	Bedrock	1044	36.5	435.958	724.628	-431.608	0	-431.608
2	2.67874	872.503	Bedrock	1044	36.5	498.26	828.183	-291.661	0	-291.661
3	2.67874	1442.97	Bedrock	1044	36.5	559.362	929.744	-154.407	0	-154.407
4	2.67874	1909.18	Bedrock	1044	36.5	609.298	1012.74	-42.2401	0	-42.2401
5	2.67874	2349.9	Bedrock	1044	36.5	656.503	1091.21	63.7949	0	63.7949
6	2.67874	2785.18	Bedrock	1044	36.5	703.125	1168.7	168.521	0	168.521
7	2.67874	3172.9	Bedrock	1044	36.5	744.653	1237.72	261.806	0	261.806
8	2.67874	3549.55	Bedrock	1044	36.5	784.996	1304.78	352.426	0	352.426

 BYER GEOTECHNICAL INC.	Project			BG 21898 HARVARD-WESTLAKE SECTION 4		
	Analysis Description			CALCULATE THE LOCATION OF THE 1.5 FACTOR OF SAFETY PLANE		
	Drawn By	R. ZWEIGLER	Scale	Company	BYER GEOTECHNICAL, INC.	
	Date	1/23/2014, 12:05:01 PM		File Name	21898 Section 4.slim	

9	2.67874	3985.69	Bedrock	1044	36.5	831.71	1382.43	457.358	0	457.358
10	2.67874	4544.95	Bedrock	1044	36.5	891.613	1481.99	591.915	0	591.915
11	2.67874	5107.98	Bedrock	1044	36.5	951.918	1582.23	727.376	0	727.376
12	2.67874	5671.01	Bedrock	1044	36.5	1012.22	1682.47	862.84	0	862.84
13	2.67874	6254.9	Bedrock	1044	36.5	1074.76	1786.42	1003.32	0	1003.32
14	2.67874	6913.86	Bedrock	1044	36.5	1145.34	1903.73	1161.86	0	1161.86
15	2.67874	7854.76	Bedrock	1044	36.5	1246.12	2071.24	1388.24	0	1388.24
16	2.67874	8795.71	Bedrock	1044	36.5	1346.91	2238.76	1614.63	0	1614.63
17	2.67874	9732.74	Bedrock	1044	36.5	1447.27	2405.58	1840.07	0	1840.07
18	2.67874	10669.9	Bedrock	1044	36.5	1547.65	2572.43	2065.55	0	2065.55
19	2.67874	11627.1	Bedrock	1044	36.5	1650.17	2742.83	2295.84	0	2295.84
20	2.67874	12598.3	Bedrock	1044	36.5	1754.2	2915.74	2529.51	0	2529.51
21	2.67874	10910.6	Bedrock	1044	36.5	1573.43	2615.28	2123.47	0	2123.47
22	2.67874	4438.35	Bedrock	1044	36.5	880.194	1463.01	566.265	0	566.265
23	2.67874	3546.84	Bedrock	1044	36.5	784.706	1304.3	351.774	0	351.774
24	2.67874	3851.73	Bedrock	1044	36.5	817.362	1358.58	425.128	0	425.128
25	2.67874	1439.01	Bedrock	1044	36.5	558.938	929.038	-155.362	0	-155.362

Interslice Data

Global Minimum Query (janbu corrected) - Safety Factor: 1.66215

Slice Number	X coordinate [ft]	Y coordinate - Bottom [ft]	Interslice Normal Force [lbs]	Interslice Shear Force [lbs]	Interslice Force Angle [degrees]
1	51.0316	802.986	0	0	0
2	53.7103	799.667	-2600.4	0	0
3	56.389	796.348	-4903.13	0	0
4	59.0678	793.028	-6913.91	0	0
5	61.7465	789.709	-8686.1	0	0
6	64.4252	786.389	-10232.8	0	0
7	67.104	783.07	-11556.7	0	0
8	69.7827	779.75	-12682.1	0	0
9	72.4615	776.431	-13614.9	0	0
10	75.1402	773.111	-14324.4	0	0
11	77.8189	769.792	-14747.7	0	0
12	80.4977	766.472	-14882.9	0	0
13	83.1764	763.153	-14729.9	0	0
14	85.8551	759.834	-14278.2	0	0
15	88.5339	756.514	-13489.2	0	0
16	91.2126	753.195	-12218.6	0	0
17	93.8914	749.875	-10466.6	0	0
18	96.5701	746.556	-8235.02	0	0

 BYER GEOTECHNICAL INC.	<i>Project</i> BG 21898 HARVARD-WESTLAKE SECTION 4		
	<i>Analysis Description</i> CALCULATE THE LOCATION OF THE 1.5 FACTOR OF SAFETY PLANE		
	<i>Drawn By</i> R. ZWEIGLER	<i>Scale</i>	<i>Company</i> BYER GEOTECHNICAL, INC.
	<i>Date</i> 1/23/2014, 12:05:01 PM		<i>File Name</i> 21898 Section 4.slim

19	99.2488	743.236	-5523.82	0	0
20	101.928	739.917	-2322.8	0	0
21	104.606	736.597	1375.24	0	0
22	107.285	733.278	4209.62	0	0
23	109.964	729.958	3731.75	0	0
24	112.643	726.639	2797.64	0	0
25	115.321	723.319	2019.56	0	0
26	118	720	0	0	0

List Of Coordinates

External Boundary

X	Y
87.9478	783.684
84	785
73	790
66	795
58	800
51	803
43	810
37	815
26	820
17	825
0	835
0	675
375	675
375	715
356	715
322	720
118	720
114	741
109	742
106	776
105	784
89	784

Material Boundary

X	Y
93	782
99	780

 <p>BYER GEOTECHNICAL INC.</p>	<i>Project</i> BG 21898 HARVARD-WESTLAKE SECTION 4		
	<i>Analysis Description</i> CALCULATE THE LOCATION OF THE 1.5 FACTOR OF SAFETY PLANE		
	<i>Drawn By</i> R. ZWEIGLER	<i>Scale</i>	<i>Company</i> BYER GEOTECHNICAL, INC.
	<i>Date</i> 1/23/2014, 12:05:01 PM	<i>File Name</i> 21898 Section 4.slim	

Material Boundary

X	Y
87.9478	783.684
93	782
89	784

 BYER GEOTECHNICAL INC.	<i>Project</i> BG 21898 HARVARD-WESTLAKE SECTION 4		
	<i>Analysis Description</i> CALCULATE THE LOCATION OF THE 1.5 FACTOR OF SAFETY PLANE		
	<i>Drawn By</i> R. ZWEIGLER	<i>Scale</i>	<i>Company</i> BYER GEOTECHNICAL, INC.
	<i>Date</i> 1/23/2014, 12:05:01 PM	<i>File Name</i> 21898 Section 4.slim	

BG 21898 HARVARD-WESTLAKE
SECTION 5
DETERMINE THE LOCATION OF THE
1.5 FACTOR OF SAFETY PLANE. THE
RESULTS INDICATE PLANES. THE
AS FLAT AT 17 DEGREES RESULT
IN A FACTOR OF SAFETY OF 1.5 OR LESS.

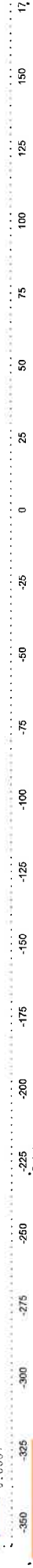
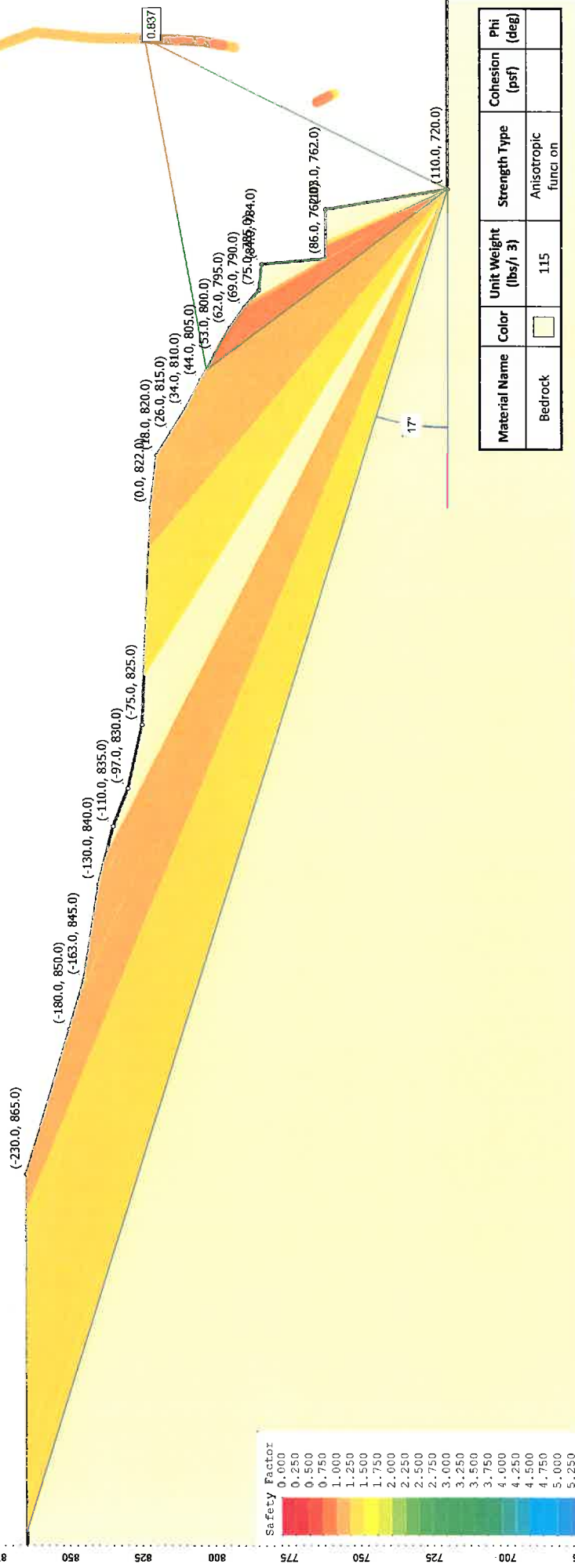

BYER GEOTECHNICAL INC.
Analysis Description
 Project: BG 21898 HARVARD-WESTLAKE SECTION 5
 Scale: 1:393
 Drawn By: R. ZWIEGLER
 Date: 4/17/15
 Company: BYER GEOTECHNICAL, INC.
 File Name: 21898 Section 5.slim



Slide Analysis Information

BG 21898 HARVARD-WESTLAKE SECTION 5

Project Summary

File Name: 21898 Section 5 fs planes
Slide Modeler Version: 6.035
Project Title: BG 21898 HARVARD-WESTLAKE SECTION 5
Analysis: CALCULATE THE LOCATION OF THE 1.5 FACTOR OF SAFETY PLANE
Author: R. ZWEIGLER
Company: BYER GEOTECHNICAL, INC.
Date Created: 4/17/15

General Settings

Units of Measurement: Imperial Units
Time Units: days
Permeability Units: feet/second
Failure Direction: Left to Right
Data Output: Standard
Maximum Material Properties: 20
Maximum Support Properties: 20

Analysis Options

Analysis Methods Used

Janbu corrected

Number of slices: 25
Tolerance: 0.005
Maximum number of iterations: 50
Check $m_{\alpha} < 0.2$: Yes
Initial trial value of FS: 1
Steffensen Iteration: Yes

Groundwater Analysis

Groundwater Method: Water Surfaces
Pore Fluid Unit Weight: 62.4 lbs/ft³
Advanced Groundwater Method: None

Random Numbers

 BYER GEOTECHNICAL INC.	<i>Project</i>			BG 21898 HARVARD-WESTLAKE SECTION 5	
	<i>Analysis Description</i> CALCULATE THE LOCATION OF THE 1.5 FACTOR OF SAFETY PLANE				
	<i>Drawn By</i>	R. ZWEIGLER	<i>Scale</i>	<i>Company</i>	BYER GEOTECHNICAL, INC.
	<i>Date</i>	4/17/15		<i>File Name</i>	21898 Section 5 fs planes.slim
SLIDEINTERPRET 6.035					

Surface Options

Surface Type: Non-Circular Block Search
 Number of Surfaces: 5000
 Pseudo-Random Surfaces: Enabled
 Convex Surfaces Only: Disabled
 Left Projection Angle (Start Angle): 95
 Left Projection Angle (End Angle): 220
 Right Projection Angle (Start Angle): -85
 Right Projection Angle (End Angle): 85
 Minimum Elevation: Not Defined
 Minimum Depth: Not Defined

Material Properties

Property	Bedrock
Color	<input type="checkbox"/>
Strength Type	Anisotropic function
Unit Weight [lbs/ft3]	115
Water Surface	None
Ru Value	0

Anisotropic Functions

Name: User Defined 1

Angle From	Angle To	c	phi
-90	-65	540	36
-65	-53	510	19.5
-53	-27	540	36
-27	-15	510	19.5
-15	90	540	36

Global Minimums

Method: janbu corrected

FS: 0.837050
 Axis Location: 161.810, 824.135
 Left Slip Surface Endpoint: 47.416, 803.102
 Right Slip Surface Endpoint: 110.000, 720.000
 Resisting Horizontal Force=46841.8 lb
 Driving Horizontal Force=55960.5 lb

 BYER GEOTECHNICAL INC.	Project			BG 21898 HARVARD-WESTLAKE SECTION 5		
	Analysis Description					CALCULATE THE LOCATION OF THE 1.5 FACTOR OF SAFETY PLANE
	Drawn By	R. ZWEIGLER	Scale	Company	BYER GEOTECHNICAL, INC.	
	Date	4/17/15			File Name	21898 Section 5 fs planes.slim

Global Minimum Coordinates

Method: janbu corrected

X	Y
47.4159	803.102
110	720

Valid / Invalid Surfaces

Method: janbu corrected

Number of Valid Surfaces: 3917
 Number of Invalid Surfaces: 1083

Error Codes:

Error Code -108 reported for 1083 surfaces

Error Codes

The following errors were encountered during the computation:

-108 = Total driving moment or total driving force < 0.1. This is to limit the calculation of extremely high safety factors if the driving force is very small (0.1 is an arbitrary number).

Slice Data

Global Minimum Query (janbu corrected) - Safety Factor: 0.83705

Slice Number	Width [ft]	Weight [lbs]	Base Material	Base Cohesion [psf]	Base Friction Angle [degrees]	Shear Stress [psf]	Shear Strength [psf]	Base Normal Stress [psf]	Pore Pressure [psf]	Effective Normal Stress [psf]
1	2.50336	278.291	Bedrock	510	19.5	420.28	351.795	-446.757	0	-446.757
2	2.50336	834.872	Bedrock	510	19.5	480.511	402.212	-304.383	0	-304.383
3	2.50336	1391.45	Bedrock	510	19.5	540.744	452.63	-162.008	0	-162.008
4	2.50336	1948.03	Bedrock	510	19.5	600.977	503.047	-19.6335	0	-19.6335
5	2.50336	2504.62	Bedrock	510	19.5	661.209	553.465	122.741	0	122.741
6	2.50336	3059.46	Bedrock	510	19.5	721.253	603.725	264.672	0	264.672
7	2.50336	3540.65	Bedrock	510	19.5	773.328	647.314	387.761	0	387.761
8	2.50336	3982.84	Bedrock	510	19.5	821.18	687.369	500.875	0	500.875
9	2.50336	4418.9	Bedrock	510	19.5	868.37	726.869	612.419	0	612.419
10	2.50336	4791.89	Bedrock	510	19.5	908.734	760.656	707.829	0	707.829
11	2.50336	5148.28	Bedrock	510	19.5	947.302	792.939	798.996	0	798.996

 BYER GEOTECHNICAL INC.	Project		BG 21898 HARVARD-WESTLAKE SECTION 5		
	Analysis Description				CALCULATE THE LOCATION OF THE 1.5 FACTOR OF SAFETY PLANE
	Drawn By	R. ZWEIGLER	Scale	Company	
	Date	4/17/15	File Name		21898 Section 5 fs planes.slim
SLIDEINTERPRET 6.035					

12	2.50336	5755.22	Bedrock	510	19.5	1012.98	847.918	954.25	0	954.25
13	2.50336	6632.01	Bedrock	510	19.5	1107.87	927.342	1178.54	0	1178.54
14	2.50336	7508.9	Bedrock	510	19.5	1202.76	1006.77	1402.85	0	1402.85
15	2.50336	7801.09	Bedrock	510	19.5	1234.39	1033.24	1477.59	0	1477.59
16	2.50336	3675.88	Bedrock	510	19.5	787.961	659.563	422.351	0	422.351
17	2.50336	3957.07	Bedrock	510	19.5	818.391	685.034	494.281	0	494.281
18	2.50336	4914.03	Bedrock	510	19.5	921.952	771.72	739.074	0	739.074
19	2.50336	5870.99	Bedrock	510	19.5	1025.51	858.406	983.868	0	983.868
20	2.50336	6827.96	Bedrock	510	19.5	1129.07	945.091	1228.66	0	1228.66
21	2.50336	7784.92	Bedrock	510	19.5	1232.63	1031.78	1473.45	0	1473.45
22	2.50336	8741.88	Bedrock	510	19.5	1336.2	1118.46	1718.24	0	1718.24
23	2.50336	8328.11	Bedrock	510	19.5	1291.42	1080.98	1612.4	0	1612.4
24	2.50336	5050.73	Bedrock	510	19.5	936.745	784.102	774.042	0	774.042
25	2.50336	1683.58	Bedrock	510	19.5	572.357	479.092	-87.2826	0	-87.2826

Interslice Data

Global Minimum Query (janbu corrected) - Safety Factor: 0.83705

Slice Number	X coordinate [ft]	Y coordinate - Bottom [ft]	Interslice Normal Force [lbs]	Interslice Shear Force [lbs]	Interslice Force Angle [degrees]
1	47.4159	803.102	0	0	0
2	49.9193	799.778	-2536.9	0	0
3	52.4226	796.454	-4751.28	0	0
4	54.926	793.13	-6643.14	0	0
5	57.4294	789.806	-8212.48	0	0
6	59.9327	786.482	-9459.29	0	0
7	62.4361	783.158	-10384.6	0	0
8	64.9394	779.834	-11031.1	0	0
9	67.4428	776.51	-11421.3	0	0
10	69.9462	773.185	-11558.8	0	0
11	72.4495	769.861	-11480.3	0	0
12	74.9529	766.537	-11195.1	0	0
13	77.4563	763.213	-10558.3	0	0
14	79.9596	759.889	-9413.46	0	0
15	82.463	756.565	-7760.45	0	0
16	84.9664	753.241	-5938.13	0	0
17	87.4697	749.917	-6506.23	0	0
18	89.9731	746.593	-6911.4	0	0
19	92.4765	743.269	-6762.03	0	0
20	94.9798	739.945	-6058.13	0	0
21	97.4832	736.62	-4799.71	0	0
22	99.9865	733.296	-2986.75	0	0
23	102.49	729.972	-619.27	0	0

	Project			BG 21898 HARVARD-WESTLAKE SECTION 5	
	Analysis Description			CALCULATE THE LOCATION OF THE 1.5 FACTOR OF SAFETY PLANE	
	Drawn By	R. ZWEIGLER	Scale	Company	BYER GEOTECHNICAL, INC.
	Date	4/17/15		File Name	21898 Section 5 fs planes.slim

24	104.993	726.648	1508.45	0	0
25	107.497	723.324	1737.02	0	0
26	110	720	0	0	0

List Of Coordinates

External Boundary

X	Y
103	762
86	762
84	784
75	785
69	790
62	795
53	800
44	805
34	810
26	815
18	820
0	822
-75	825
-97	830
-110	835
-130	840
-163	845
-180	850
-230	865
-400	865
-400	675
217	675
217	720
110	720

 BYER GEOTECHNICAL INC.	<i>Project</i> BG 21898 HARVARD-WESTLAKE SECTION 5			
	<i>Analysis Description</i> CALCULATE THE LOCATION OF THE 1.5 FACTOR OF SAFETY PLANE			
	<i>Drawn By</i> R. ZWEIGLER	<i>Scale</i>	<i>Company</i> BYER GEOTECHNICAL, INC.	
	<i>Date</i> 4/17/15		<i>File Name</i> 21898 Section 5 fs planes.slim	

BG 21898 HARVARD-WESTLAKE SECTION 5

CALCULATE THE GROSS STABILITY OF FAILURES ABOVE THE PROPOSED SOIL NAIL WALL. SHOW THE 250 MOST CRITICAL TRIALS.

THE FACTORS OF SAFETY ARE IN EXCESS OF 1.5. THEREFORE, THE SLOPE ABOVE THE PROPOSED SOIL NAILS IS CONSIDERED TO BE GROSSLY STABLE.

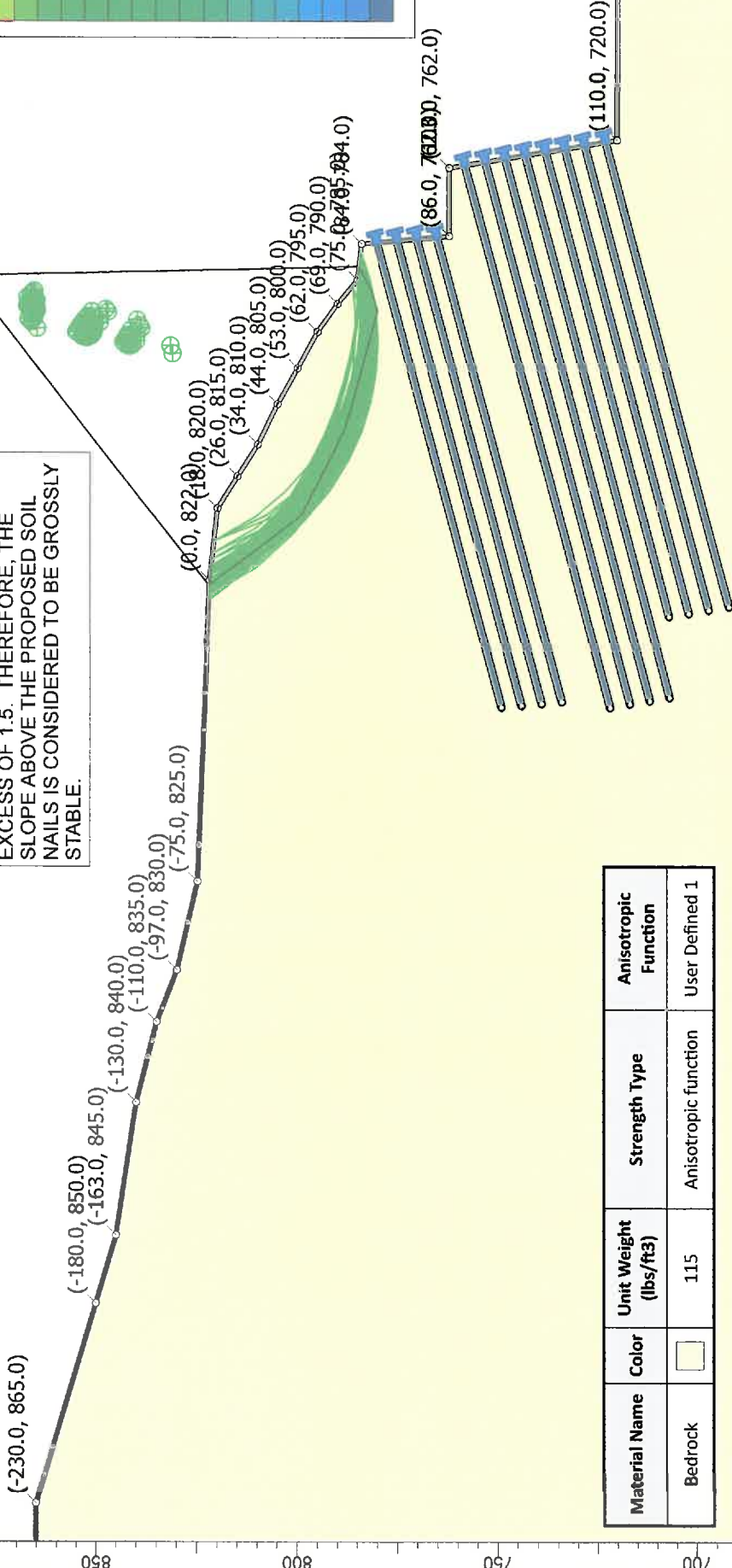
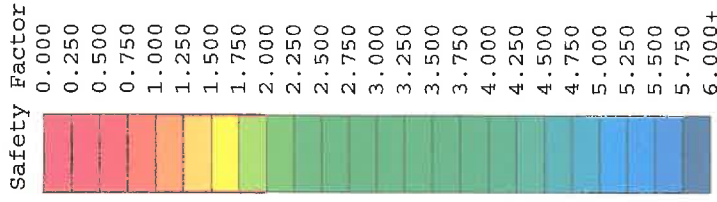

Material Name	Color	Unit Weight (lbs/ft ³)	Strength Type	Anisotropic Function
Bedrock	<input type="checkbox"/>	115	Anisotropic function	User Defined 1



Project
BG 21898 HARVARD-WESTLAKE SECTION 5

Analysis Description
CALCULATE THE GROSS STABILITY OF TRIALS ABOVE THE SOIL NAILS

Drawn By
R. ZWEIGLER

Date
4/17/15

Company
BYER GEOTECHNICAL, INC.

Scale
1:493

File Name
21898 Section 5 Above soil nails.slm

Slide Analysis Information

BG 21898 HARVARD-WESTLAKE SECTION 5

Project Summary

File Name: 21898 Section 5 Above soil nails
Slide Modeler Version: 6.034
Project Title: BG 21898 HARVARD-WESTLAKE SECTION 5
Analysis: CALCULATE THE GROSS STABILITY OF TRIALS ABOVE THE SOIL NAILS
Author: R. ZWEIGLER
Company: BYER GEOTECHNICAL, INC.
Date Created: 4/17/15

General Settings

Units of Measurement: Imperial Units
Time Units: days
Permeability Units: feet/second
Failure Direction: Left to Right
Data Output: Standard
Maximum Material Properties: 20
Maximum Support Properties: 20

Analysis Options

Analysis Methods Used

Janbu corrected

Number of slices: 25
Tolerance: 0.005
Maximum number of iterations: 50
Check $m\alpha < 0.2$: Yes
Initial trial value of FS: 1
Steffensen Iteration: Yes

Groundwater Analysis

Groundwater Method: Water Surfaces
Pore Fluid Unit Weight: 62.4 lbs/ft³
Advanced Groundwater Method: None

 BYER GEOTECHNICAL INC.	<i>Project</i> BG 21898 HARVARD-WESTLAKE SECTION 5		
	<i>Analysis Description</i> CALCULATE THE GROSS STABILITY OF TRIALS ABOVE THE SOIL NAILS		
	<i>Drawn By</i> R. ZWEIGLER	<i>Scale</i>	<i>Company</i> BYER GEOTECHNICAL, INC.
	<i>Date</i> 4/17/15	<i>File Name</i> 21898 Section 5 Above soil nails.slim	

Random Numbers

Pseudo-random Seed: 10116

Random Number Generation Method: Park and Miller v.3

Surface Options

Search Method: Auto Refine Search

Divisions along slope: 10

Circles per division: 10

Number of iterations: 10

Divisions to use in next iteration: 50%

Number of vertices per surface: 12

Minimum Elevation: Not Defined

Minimum Depth: Not Defined

Material Properties

Property	Bedrock
Color	<input type="checkbox"/>
Strength Type	Anisotropic function
Unit Weight [lbs/ft ³]	115
Water Surface	None
Ru Value	0

Anisotropic Functions

Name: User Defined 1

Angle From	Angle To	c	phi
-90	-65	540	36
-65	-53	510	19.5
-53	-27	540	36
-27	-15	510	19.5
-15	90	540	36

Support Properties

Soil Nail

Support Type: Soil Nail

Force Application: Passive

 BYER GEOTECHNICAL INC.	<i>Project</i> BG 21898 HARVARD-WESTLAKE SECTION 5		
	<i>Analysis Description</i> CALCULATE THE GROSS STABILITY OF TRIALS ABOVE THE SOIL NAILS		
	<i>Drawn By</i> R. ZWEIGLER	<i>Scale</i>	<i>Company</i> BYER GEOTECHNICAL, INC.
	<i>Date</i> 4/17/15	<i>File Name</i> 21898 Section 5 Above soil nails.slim	

Out-of-Plane Spacing: 5 ft
 Tensile Capacity: 93750 lb
 Plate Capacity: 37100 lb
 Bond Strength: 2413 lb/ft

Global Minimums

Method: janbu corrected

FS: 1.886700
 Axis Location: 75.968, 882.819
 Left Slip Surface Endpoint: -1.185, 822.047
 Right Slip Surface Endpoint: 78.293, 784.634
 Resisting Horizontal Force=90229.2 lb
 Driving Horizontal Force=47823.8 lb
 Total Slice Area=1167.19 ft2

Global Minimum Coordinates

Method: janbu corrected

X	Y
-1.18498	822.047
8.17445	809.627
14.1696	801.671
16.1541	799.038
20.5441	796.801
32.2639	790.829
38.3173	788.031
44.6005	786.14
54.8935	783.382
67.338	780.048
72.6864	781.597
78.2934	784.634

Valid / Invalid Surfaces

Method: janbu corrected

Number of Valid Surfaces: 2959
 Number of Invalid Surfaces: 1542

Error Codes:

 BYER GEOTECHNICAL INC.	<i>Project</i> BG 21898 HARVARD-WESTLAKE SECTION 5		
	<i>Analysis Description</i> CALCULATE THE GROSS STABILITY OF TRIALS ABOVE THE SOIL NAILS		
	<i>Drawn By</i> R. ZWEIGLER	<i>Scale</i>	<i>Company</i> BYER GEOTECHNICAL, INC.
	<i>Date</i> 4/17/15	<i>File Name</i> 21898 Section 5 Above soil nails.slim	

Error Code -105 reported for 497 surfaces
 Error Code -106 reported for 700 surfaces
 Error Code -107 reported for 2 surfaces
 Error Code -108 reported for 340 surfaces
 Error Code -1000 reported for 3 surfaces

Error Codes

The following errors were encountered during the computation:

- 105 = More than two surface / slope intersections with no valid slip surface.
- 106 = Average slice width is less than 0.0001 * (maximum horizontal extent of soil region). This limitation is imposed to avoid numerical errors which may result from too many slices, or too small a slip region.
- 107 = Total driving moment or total driving force is negative. This will occur if the wrong failure direction is specified, or if high external or anchor loads are applied against the failure direction.
- 108 = Total driving moment or total driving force < 0.1. This is to limit the calculation of extremely high safety factors if the driving force is very small (0.1 is an arbitrary number).
- 1000 = No valid slip surfaces are generated at a grid center. Unable to draw a surface.

Slice Data

Global Minimum Query (Janbu corrected) - Safety Factor: 1.8867

Slice Number	Width [ft]	Weight [lbs]	Base Material	Base Cohesion [psf]	Base Friction Angle [degrees]	Shear Stress [psf]	Shear Strength [psf]	Base Normal Stress [psf]	Pore Pressure [psf]	Effective Normal Stress [psf]
1	3.11981	705	Bedrock	510	19.5	247.314	466.607	-122.538	0	-122.538
2	3.11981	2071.76	Bedrock	510	19.5	312.341	589.293	223.918	0	223.918
3	3.11981	3432.78	Bedrock	510	19.5	377.094	711.464	568.918	0	568.918
4	2.9976	4580.4	Bedrock	510	19.5	440.58	831.242	907.16	0	907.16
5	2.9976	5836.87	Bedrock	510	19.5	502.797	948.627	1238.64	0	1238.64
6	1.98442	4555.24	Bedrock	510	19.5	554.499	1046.17	1514.11	0	1514.11
7	4.39007	10936.8	Bedrock	510	19.5	669.874	1263.85	2128.8	0	2128.8
8	3.9066	9606.73	Bedrock	510	19.5	664.395	1253.51	2099.62	0	2099.62
9	3.9066	9404.07	Bedrock	510	19.5	655.556	1236.84	2052.53	0	2052.53
10	3.9066	9201.4	Bedrock	510	19.5	646.716	1220.16	2005.43	0	2005.43
11	3.02666	6976.62	Bedrock	510	19.5	643.644	1214.36	1989.06	0	1989.06
12	3.02666	6915.26	Bedrock	510	19.5	640.16	1207.79	1970.5	0	1970.5
13	3.1416	7044.28	Bedrock	510	19.5	652.059	1230.24	2033.89	0	2033.89
14	3.1416	6817.16	Bedrock	510	19.5	639.258	1206.09	1965.69	0	1965.69
15	3.431	7115.18	Bedrock	510	19.5	626.11	1181.28	1895.64	0	1895.64
16	3.431	6725.83	Bedrock	510	19.5	605.891	1143.13	1787.92	0	1787.92
17	3.431	6336.48	Bedrock	510	19.5	585.671	1104.99	1680.19	0	1680.19
18	3.11115	5409.18	Bedrock	510	19.5	566.395	1068.62	1577.48	0	1577.48
19	3.11115	5089.04	Bedrock	510	19.5	548.06	1034.03	1479.8	0	1479.8
20	3.11115	4723.64	Bedrock	510	19.5	527.134	994.543	1368.31	0	1368.31

 BYER GEOTECHNICAL INC.	Project		BG 21898 HARVARD-WESTLAKE SECTION 5		
	Analysis Description				CALCULATE THE GROSS STABILITY OF TRIALS ABOVE THE SOIL NAILS
	Drawn By	R. ZWEIGLER	Scale	Company	
	Date	4/17/15	File Name		21898 Section 5 Above soil nails.slim
SLIDEINTERPRET 6.034					

21	3.11115	4233.96	Bedrock	510	19.5	499.089	941.631	1218.89	0	1218.89
22	2.67416	3005.92	Bedrock	540	36	815.694	1538.97	1374.96	0	1374.96
23	2.67416	2101.29	Bedrock	540	36	667.921	1260.17	991.224	0	991.224
24	2.80352	1107.37	Bedrock	540	36	563.042	1062.29	718.872	0	718.872
25	2.80352	295.027	Bedrock	540	36	419.71	791.866	346.663	0	346.663

Interslice Data

Global Minimum Query (Janbu corrected) - Safety Factor: 1.8867

Slice Number	X coordinate [ft]	Y coordinate - Bottom [ft]	Interslice Normal Force [lbs]	Interslice Shear Force [lbs]	Interslice Force Angle [degrees]
1	-1.18498	822.047	0	0	0
2	1.93483	817.907	-1326.66	0	0
3	5.05464	813.767	-1434.38	0	0
4	8.17445	809.627	-328.281	0	0
5	11.1721	805.649	1877.91	0	0
6	14.1696	801.671	5204.69	0	0
7	16.1541	799.038	8023.49	0	0
8	20.5441	796.801	9662.48	0	0
9	24.4507	794.81	11085.6	0	0
10	28.3573	792.82	12451.6	0	0
11	32.2639	790.829	13760.6	0	0
12	35.2906	789.43	14475.2	0	0
13	38.3173	788.031	15175	0	0
14	41.4589	787.085	14922.4	0	0
15	44.6005	786.14	14648.1	0	0
16	48.0315	785.221	14109.6	0	0
17	51.4625	784.301	13545.8	0	0
18	54.8935	783.382	12956.7	0	0
19	58.0046	782.548	12400.5	0	0
20	61.1158	781.715	11823.4	0	0
21	64.2269	780.881	11222.6	0	0
22	67.338	780.048	10589.8	0	0
23	70.0122	780.822	7208.43	0	0
24	72.6864	781.597	4543.91	0	0
25	75.4899	783.115	1775.97	0	0
26	78.2934	784.634	0	0	0

List Of Coordinates

	Project				BG 21898 HARVARD-WESTLAKE SECTION 5		
	Analysis Description				CALCULATE THE GROSS STABILITY OF TRIALS ABOVE THE SOIL NAILS		
	Drawn By		R. ZWEIGLER	Scale		Company	BYER GEOTECHNICAL, INC.
	Date		4/17/15		File Name		21898 Section 5 Above soil nails.slim

External Boundary

X	Y
103	762
86	762
84	784
75	785
69	790
62	795
53	800
44	805
34	810
26	815
18	820
0	822
-75	825
-97	830
-110	835
-130	840
-163	845
-180	850
-230	865
-400	865
-400	675
217	675
217	720
110	720



**BYER
GEOTECHNICAL
INC.**

<i>Project</i>		BG 21898 HARVARD-WESTLAKE SECTION 5	
<i>Analysis Description</i>		CALCULATE THE GROSS STABILITY OF TRIALS ABOVE THE SOIL NAILS	
<i>Drawn By</i>	R. ZWEIGLER	<i>Scale</i>	<i>Company</i> BYER GEOTECHNICAL, INC.
<i>Date</i>	4/17/15	<i>File Name</i>	21898 Section 5 Above soil nails.slim

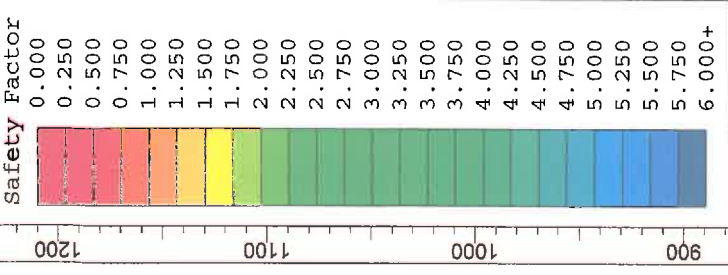

BG 21898 HARVARD-WESTLAKE SECTION 5

CALCULATE THE SEISMIC STABILITY OF FAILURES ABOVE THE PROPOSED SOIL NAIL WALL. SHOW THE 250 MOST CRITICAL TRIALS.

THE FACTORS OF SAFETY ARE IN EXCESS OF 1.0. THEREFORE, THE SLOPE ABOVE THE PROPOSED SOIL NAILS IS CONSIDERED TO BE SEISMICALLY STABLE.

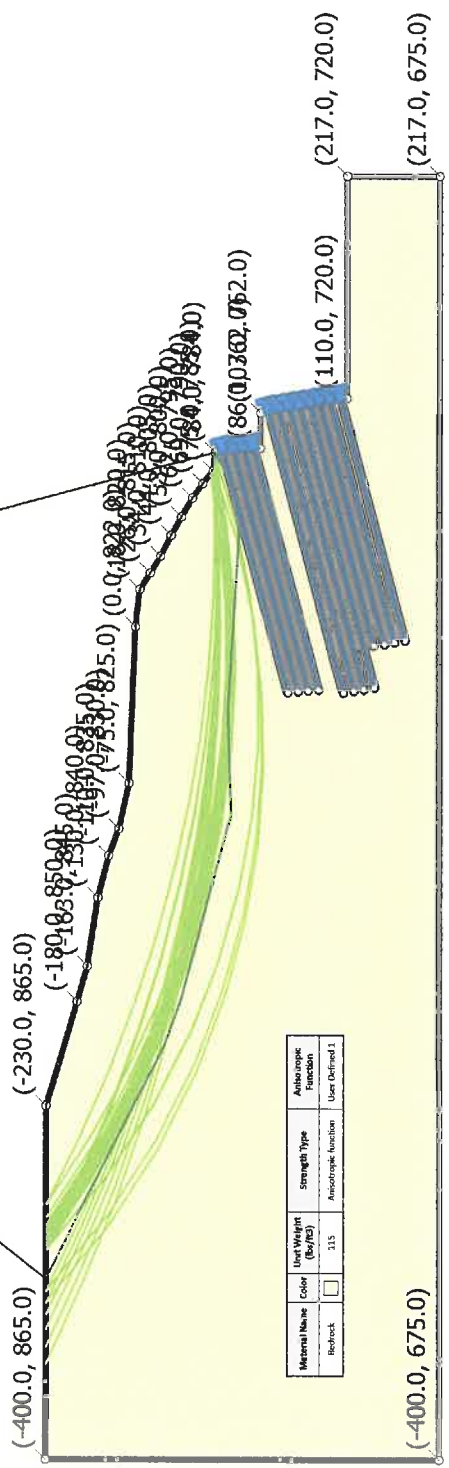

Material Name	Color	Unit Weight (lb/ft ³)	Strength Type	Anisotropic Function
Reinforced		115	Anisotropic Function	User Defined 1

Project BG 21898 HARVARD-WESTLAKE SECTION 5

Analysis Description CALCULATE THE SEISMIC STABILITY OF TRIALS ABOVE THE SOIL NAILS

Drawn By R. ZWEIGLER **Scale** 1:1113 **Company** BYER GEOTECHNICAL, INC.

Date 4/17/15 **File Name** 21898 Section 5 Above soil nails EQ updated.slm

Slide Analysis Information

BG 21898 HARVARD-WESTLAKE SECTION 5

Project Summary

File Name: 21898 Section 5 Above soil nails EQ updated
Slide Modeler Version: 6.034
Project Title: BG 21898 HARVARD-WESTLAKE SECTION 5
Analysis: CALCULATE THE SEISMIC STABILITY OF TRIALS ABOVE THE SOIL NAILS
Author: R. ZWEIGLER
Company: BYER GEOTECHNICAL, INC.
Date Created: 4/17/15

General Settings

Units of Measurement: Imperial Units
Time Units: days
Permeability Units: feet/second
Failure Direction: Left to Right
Data Output: Standard
Maximum Material Properties: 20
Maximum Support Properties: 20

Analysis Options

Analysis Methods Used

Janbu corrected

Number of slices: 25
Tolerance: 0.005
Maximum number of iterations: 50
Check malpha < 0.2: Yes
Initial trial value of FS: 1
Steffensen Iteration: Yes

Groundwater Analysis

Groundwater Method: Water Surfaces
Pore Fluid Unit Weight: 62.4 lbs/ft³
Advanced Groundwater Method: None

 BYER GEOTECHNICAL INC.	<i>Project</i> BG 21898 HARVARD-WESTLAKE SECTION 5		
	<i>Analysis Description</i> CALCULATE THE SEISMIC STABILITY OF TRIALS ABOVE THE SOIL NAILS		
	<i>Drawn By</i> R. ZWEIGLER	<i>Scale</i>	<i>Company</i> BYER GEOTECHNICAL, INC.
	<i>Date</i> 4/17/15	<i>File Name</i> 21898 Section 5 Above soil nails EQ updated.slim	

Random Numbers

Pseudo-random Seed: 10116

Random Number Generation Method: Park and Miller v.3

Surface Options

Search Method: Auto Refine Search

Divisions along slope: 10

Circles per division: 10

Number of iterations: 10

Divisions to use in next iteration: 50%

Number of vertices per surface: 12

Minimum Elevation: Not Defined

Minimum Depth: Not Defined

Loading

Seismic Load Coefficient (Horizontal): 0.29

Material Properties

Property	Bedrock
Color	<input type="checkbox"/>
Strength Type	Anisotropic function
Unit Weight [lbs/ft3]	115
Water Surface	None
Ru Value	0

Anisotropic Functions

Name: User Defined 1

Angle From	Angle To	c	phi
-90	-65	825	37
-65	-53	700	23
-53	-27	825	37
-27	-15	700	23
-15	90	825	37

Support Properties

 BYER GEOTECHNICAL INC.	Project			BG 21898 HARVARD-WESTLAKE SECTION 5
	Analysis Description			CALCULATE THE SEISMIC STABILITY OF TRIALS ABOVE THE SOIL NAILS
	Drawn By	R. ZWEIGLER	Scale	Company BYER GEOTECHNICAL, INC.
	Date	4/17/15		File Name 21898 Section 5 Above soil nails EQ updated.slim

Soil Nail

Support Type: Soil Nail
Force Application: Passive
Out-of-Plane Spacing: 5 ft
Tensile Capacity: 125000 lb
Plate Capacity: 37100 lb
Bond Strength: 3217 lb/ft

Global Minimums

Method: janbu corrected

FS: 1.594220
Axis Location: -33.574, 1221.648
Left Slip Surface Endpoint: -313.148, 865.000
Right Slip Surface Endpoint: 84.000, 784.000
Resisting Horizontal Force=1.32295e+006 lb
Driving Horizontal Force=829841 lb
Total Slice Area=15548.5 ft²

Global Minimum Coordinates

Method: janbu corrected

X	Y
-313.148	865
-275.162	845.645
-229.37	822.313
-201.313	808.017
-180.137	800.322
-123.037	785.022
-90.3557	776.265
-39.5336	777.603
2.76093	775.022
45.0555	772.441
62.2639	774.223
72.0743	777.253
84	784

Valid / Invalid Surfaces

 BYER GEOTECHNICAL INC.	Project BG 21898 HARVARD-WESTLAKE SECTION 5		
	Analysis Description CALCULATE THE SEISMIC STABILITY OF TRIALS ABOVE THE SOIL NAILS		
	Drawn By R. ZWEIGLER	Scale	Company BYER GEOTECHNICAL, INC.
	Date 4/17/15	File Name 21898 Section 5 Above soil nails EQ updated.slim	

Method: janbu corrected

Number of Valid Surfaces: 3207
 Number of Invalid Surfaces: 1294

Error Codes:

- Error Code -105 reported for 204 surfaces
- Error Code -106 reported for 890 surfaces
- Error Code -108 reported for 196 surfaces
- Error Code -112 reported for 1 surface
- Error Code -1000 reported for 3 surfaces

Error Codes

The following errors were encountered during the computation:

- 105 = More than two surface / slope intersections with no valid slip surface.
- 106 = Average slice width is less than 0.0001 * (maximum horizontal extent of soil region). This limitation is imposed to avoid numerical errors which may result from too many slices, or too small a slip region.
- 108 = Total driving moment or total driving force < 0.1. This is to limit the calculation of extremely high safety factors if the driving force is very small (0.1 is an arbitrary number).
- 112 = The coefficient M-Alpha = $\cos(\alpha)(1+\tan(\alpha)\tan(\phi)/F) < 0.2$ for the final iteration of the safety factor calculation. This screens out some slip surfaces which may not be valid in the context of the analysis, in particular, deep seated slip surfaces with many high negative base angle slices in the passive zone.
- 1000 = No valid slip surfaces are generated at a grid center. Unable to draw a surface.

Slice Data

Global Minimum Query (janbu corrected) - Safety Factor: 1.59422

Slice Number	Width [ft]	Weight [lbs]	Base Material	Base Cohesion [psf]	Base Friction Angle [degrees]	Shear Stress [psf]	Shear Strength [psf]	Base Normal Stress [psf]	Pore Pressure [psf]	Effective Normal Stress [psf]
1	18.9932	10568.9	Bedrock	700	23	514.351	819.989	282.677	0	282.677
2	18.9932	31706.6	Bedrock	700	23	773.891	1233.75	1257.44	0	1257.44
3	15.2641	40801.5	Bedrock	700	23	1007.95	1606.9	2136.52	0	2136.52
4	15.2641	54453.9	Bedrock	700	23	1216.53	1939.42	2919.9	0	2919.9
5	15.2641	68099.5	Bedrock	700	23	1425.01	2271.78	3702.89	0	3702.89
6	14.0284	70932.2	Bedrock	700	23	1563.76	2492.97	4223.96	0	4223.96
7	14.0284	75674.1	Bedrock	700	23	1642.58	2618.64	4520.02	0	4520.02
8	21.1754	119440	Bedrock	700	23	1762.76	2810.22	4971.34	0	4971.34
9	19.0335	108310	Bedrock	700	23	1818.68	2899.38	5181.45	0	5181.45
10	19.0335	110753	Bedrock	700	23	1850.48	2950.08	5300.86	0	5300.86
11	19.0335	115329	Bedrock	700	23	1910.06	3045.06	5524.61	0	5524.61
12	16.3406	100233	Bedrock	700	23	1928.57	3074.56	5594.12	0	5594.12
13	16.3406	98365.2	Bedrock	700	23	1900.25	3029.42	5487.76	0	5487.76

 <p>BYER GEOTECHNICAL INC.</p>	Project		BG 21898 HARVARD-WESTLAKE SECTION 5		
	Analysis Description		CALCULATE THE SEISMIC STABILITY OF TRIALS ABOVE THE SOIL NAILS		
	Drawn By	R. ZWEIGLER	Scale	Company	BYER GEOTECHNICAL, INC.
	Date	4/17/15		File Name	21898 Section 5 Above soil nails EQ updated.slim

14	16.9407	97585.3	Bedrock	825	37	3282.99	5233.81	5850.69	0	5850.69
15	16.9407	92857.3	Bedrock	825	37	3149.33	5020.73	5567.92	0	5567.92
16	16.9407	90668.5	Bedrock	825	37	3087.45	4922.08	5437.01	0	5437.01
17	14.0982	74784.6	Bedrock	825	37	2936.36	4681.21	5117.36	0	5117.36
18	14.0982	75265.2	Bedrock	825	37	2952	4706.14	5150.45	0	5150.45
19	14.0982	75714.6	Bedrock	825	37	2966.63	4729.46	5181.4	0	5181.4
20	14.0982	75095.4	Bedrock	825	37	2946.48	4697.33	5138.75	0	5138.75
21	14.0982	68989.6	Bedrock	825	37	2747.75	4380.52	4718.33	0	4718.33
22	14.0982	57012	Bedrock	825	37	2357.92	3759.04	3893.61	0	3893.61
23	17.2084	52048.9	Bedrock	825	37	2052.13	3271.54	3246.67	0	3246.67
24	9.81043	17501.1	Bedrock	825	37	1605.54	2559.58	2301.87	0	2301.87
25	11.9257	5890.88	Bedrock	825	37	1042.12	1661.37	1109.9	0	1109.9

Interslice Data

Global Minimum Query (janbu corrected) - Safety Factor: 1.59422

Slice Number	X coordinate [ft]	Y coordinate - Bottom [ft]	Interslice Normal Force [lbs]	Interslice Shear Force [lbs]	Interslice Force Angle [degrees]
1	-313.148	865	0	0	0
2	-294.155	855.322	-4404.89	0	0
3	-275.162	845.645	1603.82	0	0
4	-259.898	837.868	13980.3	0	0
5	-244.634	830.09	33082.7	0	0
6	-229.37	822.313	58907.6	0	0
7	-215.341	815.165	86753.4	0	0
8	-201.313	808.017	116935	0	0
9	-180.137	800.322	150832	0	0
10	-161.104	795.222	172505	0	0
11	-142.07	790.122	194864	0	0
12	-123.037	785.022	218506	0	0
13	-106.696	780.644	239146	0	0
14	-90.3557	776.265	259262	0	0
15	-73.415	776.711	226852	0	0
16	-56.4743	777.157	195564	0	0
17	-39.5336	777.603	164793	0	0
18	-25.4354	776.743	147637	0	0
19	-11.3373	775.882	130419	0	0
20	2.76093	775.022	113142	0	0
21	16.8591	774.162	95945.4	0	0
22	30.9573	773.301	79543.4	0	0
23	45.0555	772.441	64699.7	0	0

 BYER GEOTECHNICAL INC.	Project			BG 21898 HARVARD-WESTLAKE SECTION 5	
	Analysis Description			CALCULATE THE SEISMIC STABILITY OF TRIALS ABOVE THE SOIL NAILS	
	Drawn By	R. ZWEIGLER	Scale	Company	BYER GEOTECHNICAL, INC.
	Date	4/17/15		File Name	21898 Section 5 Above soil nails EQ updated.slim

24	62.2639	774.223	37116.1	0	0
25	72.0743	777.253	18763.4	0	0
26	84	784	0	0	0

List Of Coordinates

External Boundary

X	Y
103	762
86	762
84	784
75	785
69	790
62	795
53	800
44	805
34	810
26	815
18	820
0	822
-75	825
-97	830
-110	835
-130	840
-163	845
-180	850
-230	865
-400	865
-400	675
217	675
217	720
110	720

 BYER GEOTECHNICAL INC.	<i>Project</i>			
	BG 21898 HARVARD-WESTLAKE SECTION 5			
	<i>Analysis Description</i>			
	CALCULATE THE SEISMIC STABILITY OF TRIALS ABOVE THE SOIL NAILS			
<i>Drawn By</i>	R. ZWEIGLER	<i>Scale</i>	<i>Company</i>	BYER GEOTECHNICAL, INC.
<i>Date</i>	4/17/15	<i>File Name</i>	21898 Section 5 Above soil nails EQ updated.slim	

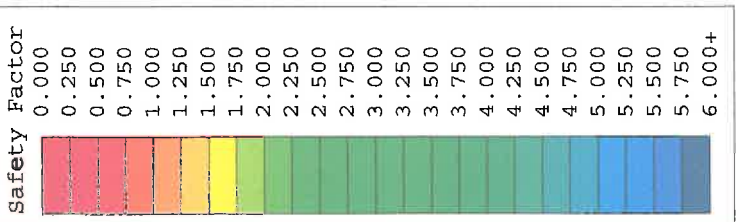

BG 21898 HARVARD-WESTLAKE SECTION 5

CALCULATE THE GROSS STABILITY OF FAILURES BELOW THE PROPOSED SOIL NAIL WALL. SHOW THE 40 MOST CRITICAL TRIALS.

THE FACTORS OF SAFETY ARE IN EXCESS OF 1.5. THEREFORE, THE SLOPE BELOW THE PROPOSED SOIL NAILS IS CONSIDERED TO BE GROSSLY STABLE.

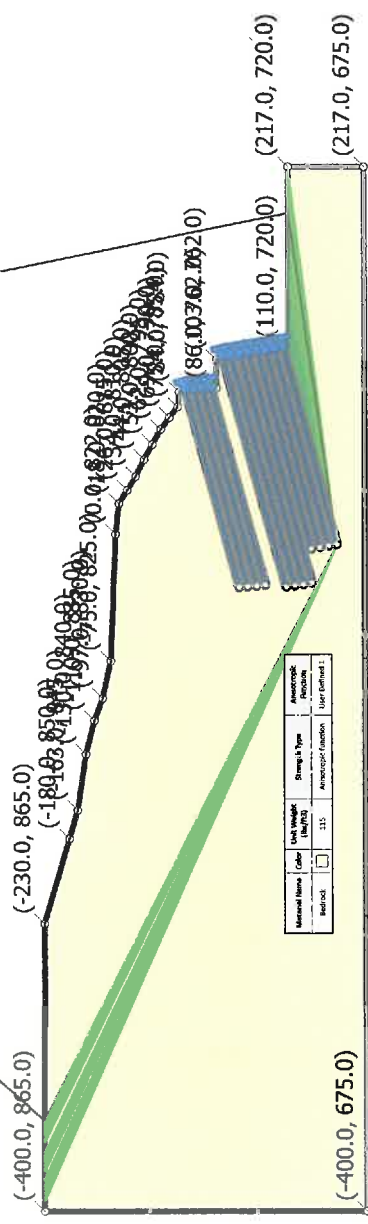
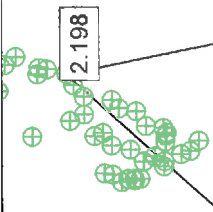

BYER GEOTECHNICAL INC.		BG 21898 HARVARD-WESTLAKE SECTION 5	
ANALYSIS DESCRIPTION: CALCULATE THE GROSS STABILITY OF TRIALS BELOW THE SOIL NAILS			
Drawn By	R. ZWEIGLER	Scale	1:1367
Date	4/17/15	Company	BYER GEOTECHNICAL, INC.
Project	BG 21898 HARVARD-WESTLAKE SECTION 5	File Name	21898 Section 5 Below soil nails updated.slim

Support Type: Soil Nail
 Force Application: Passive
 Out-of-Plane Spacing: 5 ft
 Tensile Capacity: 93750 lb
 Plate Capacity: 37100 lb
 Bond Strength: 2413 lb/ft

Global Minimums

Method: janbu corrected

FS: 2.198050
 Axis Location: 66.516, 1328.339
 Left Slip Surface Endpoint: -346.403, 865.000
 Right Slip Surface Endpoint: 189.436, 720.000
 Resisting Horizontal Force=2.28145e+006 lb
 Driving Horizontal Force=1.03794e+006 lb
 Total Slice Area=34883.3 ft2

Global Minimum Coordinates

Method: janbu corrected

X	Y
-346.403	865
-6.39	691.94
189.436	720

Valid / Invalid Surfaces

Method: janbu corrected

Number of Valid Surfaces: 2066
 Number of Invalid Surfaces: 2934

Error Codes:

Error Code -107 reported for 239 surfaces
 Error Code -108 reported for 2489 surfaces
 Error Code -112 reported for 206 surfaces

Error Codes

The following errors were encountered during the computation:

 BYER GEOTECHNICAL INC.	Project			BG 21898 HARVARD-WESTLAKE SECTION 5	
	Analysis Description				CALCULATE THE GROSS STABILITY OF TRIALS BELOW THE SOIL NAILS
	Drawn By	R. ZWEIGLER	Scale	Company	BYER GEOTECHNICAL, INC.
	Date	4/17/15		File Name	BG 21898 Section 5 Below soil nails updated.slim

- 107 = Total driving moment or total driving force is negative. This will occur if the wrong failure direction is specified, or if high external or anchor loads are applied against the failure direction.
- 108 = Total driving moment or total driving force < 0.1. This is to limit the calculation of extremely high safety factors if the driving force is very small (0.1 is an arbitrary number).
- 112 = The coefficient $M\text{-Alpha} = \cos(\alpha)(1 + \tan(\alpha)\tan(\phi))/F < 0.2$ for the final iteration of the safety factor calculation. This screens out some slip surfaces which may not be valid in the context of the analysis, in particular, deep seated slip surfaces with many high negative base angle slices in the passive zone.

Slice Data

Global Minimum Query (janbu corrected) - Safety Factor: 2.19805

Slice Number	Width [ft]	Weight [lbs]	Base Material	Base Cohesion [psf]	Base Friction Angle [degrees]	Shear Stress [psf]	Shear Strength [psf]	Base Normal Stress [psf]	Pore Pressure [psf]	Effective Normal Stress [psf]
1	21.2508	13216.6	Bedrock	510	19.5	305.688	671.918	457.243	0	457.243
2	21.2508	39649.8	Bedrock	510	19.5	490.078	1077.22	1601.77	0	1601.77
3	21.2508	66083	Bedrock	510	19.5	674.468	1482.51	2746.3	0	2746.3
4	21.2508	92516.3	Bedrock	510	19.5	858.857	1887.81	3890.83	0	3890.83
5	21.2508	118949	Bedrock	510	19.5	1043.25	2293.11	5035.34	0	5035.34
6	21.2508	143257	Bedrock	510	19.5	1212.81	2665.81	6087.84	0	6087.84
7	21.2508	155886	Bedrock	510	19.5	1300.91	2859.46	6634.7	0	6634.7
8	21.2508	166744	Bedrock	510	19.5	1376.65	3025.94	7104.82	0	7104.82
9	21.2508	178303	Bedrock	510	19.5	1457.28	3203.18	7605.3	0	7605.3
10	21.2508	195396	Bedrock	510	19.5	1576.52	3465.26	8345.41	0	8345.41
11	21.2508	212255	Bedrock	510	19.5	1694.12	3723.75	9075.37	0	9075.37
12	21.2508	223395	Bedrock	510	19.5	1771.83	3894.57	9557.73	0	9557.73
13	21.2508	236119	Bedrock	510	19.5	1860.59	4089.67	10108.7	0	10108.7
14	21.2508	257581	Bedrock	510	19.5	2010.3	4418.74	11038	0	11038
15	21.2508	281937	Bedrock	510	19.5	2180.2	4792.19	12092.5	0	12092.5
16	21.2508	306293	Bedrock	510	19.5	2350.1	5165.63	13147.1	0	13147.1
17	21.7584	320123	Bedrock	540	36	5378.4	11822	15528.4	0	15528.4
18	21.7584	295699	Bedrock	540	36	4987.78	10963.4	14346.6	0	14346.6
19	21.7584	257678	Bedrock	540	36	4379.71	9626.83	12506.9	0	12506.9
20	21.7584	217003	Bedrock	540	36	3729.19	8196.95	10538.9	0	10538.9
21	21.7584	151293	Bedrock	540	36	2678.28	5887	7359.51	0	7359.51
22	21.7584	47097.5	Bedrock	540	36	1011.87	2224.15	2318.04	0	2318.04
23	21.7584	19503.4	Bedrock	540	36	570.559	1254.12	982.9	0	982.9
24	21.7584	11702	Bedrock	540	36	445.791	979.872	605.432	0	605.432
25	21.7584	3900.68	Bedrock	540	36	321.023	705.625	227.963	0	227.963

Interslice Data

 BYER GEOTECHNICAL INC.	Project			BG 21898 HARVARD-WESTLAKE SECTION 5		
	Analysis Description			CALCULATE THE GROSS STABILITY OF TRIALS BELOW THE SOIL NAILS		
	Drawn By	R. ZWEIGLER	Scale	Company	BYER GEOTECHNICAL, INC.	
	Date	4/17/15		File Name	21898 Section 5 Below soil nails updated.slim	

Global Minimum Query (janbu corrected) - Safety Factor: 2.19805

Slice Number	X coordinate [ft]	Y coordinate - Bottom [ft]	Interslice Normal Force [lbs]	Interslice Shear Force [lbs]	Interslice Force Angle [degrees]
1	-346.403	865	0	0	0
2	-325.152	854.184	-1930.5	0	0
3	-303.901	843.367	4370.84	0	0
4	-282.65	832.551	18904	0	0
5	-261.4	821.735	41669	0	0
6	-240.149	810.919	72665.8	0	0
7	-218.898	800.102	111232	0	0
8	-197.647	789.286	153732	0	0
9	-176.396	778.47	199613	0	0
10	-155.146	767.654	249094	0	0
11	-133.895	756.837	303898	0	0
12	-112.644	746.021	363951	0	0
13	-91.3932	735.205	427475	0	0
14	-70.1424	724.389	494961	0	0
15	-48.8916	713.572	569130	0	0
16	-27.6408	702.756	650884	0	0
17	-6.39	691.94	740224	0	0
18	15.3684	695.058	567938	0	0
19	37.1269	698.176	408333	0	0
20	58.8853	701.293	268469	0	0
21	80.6437	704.411	149723	0	0
22	102.402	707.529	65092.8	0	0
23	124.161	710.647	34560.9	0	0
24	145.919	713.764	18355.7	0	0
25	167.677	716.882	6200.95	0	0
26	189.436	720	0	0	0

List Of Coordinates

External Boundary

X	Y
103	762
86	762
84	784
75	785
69	790
62	795

 <p>BYER GEOTECHNICAL INC.</p>	Project			BG 21898 HARVARD-WESTLAKE SECTION 5	
	Analysis Description			CALCULATE THE GROSS STABILITY OF TRIALS BELOW THE SOIL NAILS	
	Drawn By	R. ZWEIGLER	Scale	Company	BYER GEOTECHNICAL, INC.
	Date	4/17/15		File Name	21898 Section 5 Below soil nails updated.slim

53	800
44	805
34	810
26	815
18	820
0	822
-75	825
-97	830
-110	835
-130	840
-163	845
-180	850
-230	865
-400	865
-400	675
217	675
217	720
110	720



**BYER
GEOTECHNICAL
INC.**

<i>Project</i>			
BG 21898 HARVARD-WESTLAKE SECTION 5			
<i>Analysis Description</i>			
CALCULATE THE GROSS STABILITY OF TRIALS BELOW THE SOIL NAILS			
<i>Drawn By</i>	R. ZWEIGLER	<i>Scale</i>	<i>Company</i>
			BYER GEOTECHNICAL, INC.
<i>Date</i>	4/17/15		<i>File Name</i>
			21898 Section 5 Below soil nails updated.slim

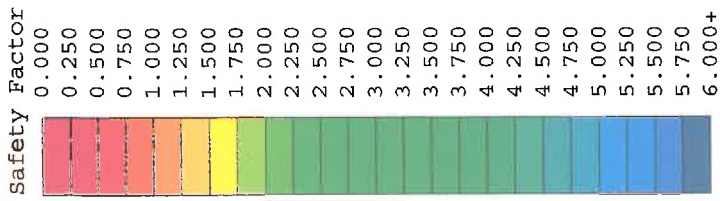

1.240



BG 21898 HARVARD-WESTLAKE SECTION 5

CALCULATE THE SEISMIC STABILITY OF FAILURES BELOW THE PROPOSED SOIL NAIL WALL. SHOW THE 40 MOST CRITICAL TRIALS.

THE FACTORS OF SAFETY ARE IN EXCESS OF 1.0. THEREFORE, THE SLOPE BELOW THE PROPOSED SOIL NAILS IS CONSIDERED TO BE SEISMICALLY STABLE.

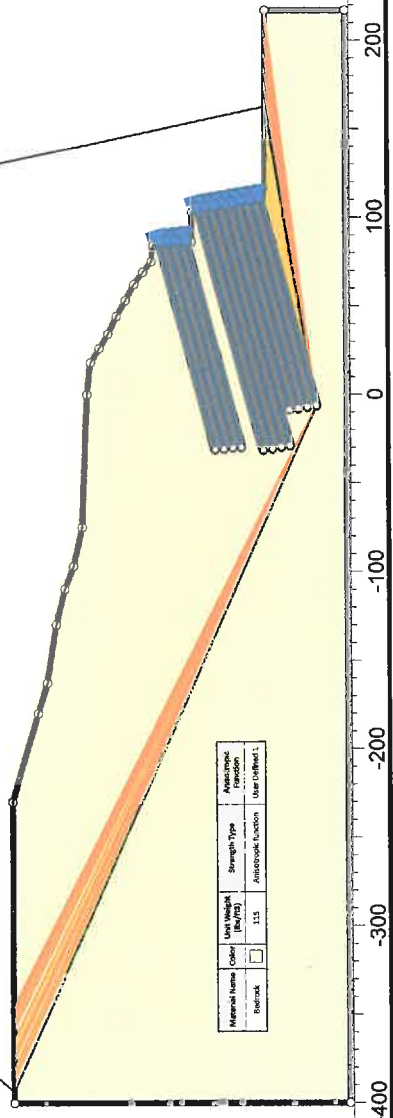

Material Name	Color	Unit Weight (lb/ft ³)	Strength Type	Associated Extension
Backfill	<input type="checkbox"/>	115	Anisotropic function	Use (d)Red 1

BYER
GEOTECHNICAL
INC.

Project
BG 21898 HARVARD-WESTLAKE SECTION 5

Analysis Description
CALCULATE THE SEISMIC STABILITY OF TRIALS BELOW THE SOIL NAILS

Drawn By
R. ZWEIGLER

Date
4/17/15

Company
BYER GEOTECHNICAL, INC.

Scale
1:1308

File Name
21898 Section 5 Below soil nails EQ updated.slm

SLIDEINTERPRET 6.034

Slide Analysis Information

BG 21898 HARVARD-WESTLAKE SECTION 5

Project Summary

File Name: 21898 Section 5 Below soil nails EQ updated
Slide Modeler Version: 6.034
Project Title: BG 21898 HARVARD-WESTLAKE SECTION 5
Analysis: CALCULATE THE SEISMIC STABILITY OF TRIALS BELOW THE SOIL NAILS
Author: R. ZWEIGLER
Company: BYER GEOTECHNICAL, INC.
Date Created: 4/17/15

General Settings

Units of Measurement: Imperial Units
Time Units: days
Permeability Units: feet/second
Failure Direction: Left to Right
Data Output: Standard
Maximum Material Properties: 20
Maximum Support Properties: 20

Analysis Options

Analysis Methods Used

Janbu corrected

Number of slices: 25
Tolerance: 0.005
Maximum number of iterations: 50
Check malpha < 0.2: Yes
Initial trial value of FS: 1
Steffensen Iteration: Yes

Groundwater Analysis

Groundwater Method: Water Surfaces
Pore Fluid Unit Weight: 62.4 lbs/ft³
Advanced Groundwater Method: None

Random Numbers

 BYER GEOTECHNICAL INC.	<i>Project</i> BG 21898 HARVARD-WESTLAKE SECTION 5		
	<i>Analysis Description</i> CALCULATE THE SEISMIC STABILITY OF TRIALS BELOW THE SOIL NAILS		
	<i>Drawn By</i> R. ZWEIGLER	<i>Scale</i>	<i>Company</i> BYER GEOTECHNICAL, INC.
	<i>Date</i> 4/17/15	<i>File Name</i> 21898 Section 5 Below soil nails EQ updated.slim	
SLIDEINTERPRET 6.035			

Surface Options

Surface Type: Non-Circular Block Search
 Number of Surfaces: 5000
 Pseudo-Random Surfaces: Enabled
 Convex Surfaces Only: Disabled
 Left Projection Angle (Start Angle): 95
 Left Projection Angle (End Angle): 220
 Right Projection Angle (Start Angle): -85
 Right Projection Angle (End Angle): 85
 Minimum Elevation: Not Defined
 Minimum Depth: Not Defined

Loading

Seismic Load Coefficient (Horizontal): 0.29

Material Properties

Property	Bedrock
Color	<input type="checkbox"/>
Strength Type	Anisotropic function
Unit Weight [lbs/ft3]	115
Water Surface	None
Ru Value	0

Anisotropic Functions

Name: User Defined 1

Angle From	Angle To	c	phi
-90	-65	825	37
-65	-53	700	23
-53	-27	825	37
-27	-15	700	23
-15	90	825	37

Support Properties

Soil Nail

Support Type: Soil Nail

 BYER GEOTECHNICAL INC.	Project BG 21898 HARVARD-WESTLAKE SECTION 5		
	Analysis Description CALCULATE THE SEISMIC STABILITY OF TRIALS BELOW THE SOIL NAILS		
	Drawn By R. ZWEIGLER	Scale	Company BYER GEOTECHNICAL, INC.
	Date 4/17/15		File Name 21898 Section 5 Below soil nails EQ updated.slim

Force Application: Passive
 Out-of-Plane Spacing: 5 ft
 Tensile Capacity: 125000 lb
 Plate Capacity: 37100 lb
 Bond Strength: 3217 lb/ft

Global Minimums

Method: janbu corrected

FS: 1.240360
 Axis Location: 29.425, 1348.544
 Left Slip Surface Endpoint: -393.597, 865.000
 Right Slip Surface Endpoint: 162.446, 720.000
 Resisting Horizontal Force=2.75554e+006 lb
 Driving Horizontal Force=2.22156e+006 lb
 Total Slice Area=38588.4 ft²

Global Minimum Coordinates

Method: janbu corrected

X	Y
-393.597	865
-6.39	691.94
162.446	720

Valid / Invalid Surfaces

Method: janbu corrected

Number of Valid Surfaces: 2004
 Number of Invalid Surfaces: 2996

Error Codes:

Error Code -108 reported for 2750 surfaces
 Error Code -112 reported for 245 surfaces
 Error Code -200 reported for 1 surface

Error Codes

The following errors were encountered during the computation:

- 108 = Total driving moment or total driving force < 0.1. This is to limit the calculation of extremely high safety factors if the driving force is very small (0.1 is an arbitrary number).
- 112 = The coefficient M-Alpha = $\cos(\alpha)(1 + \tan(\alpha)\tan(\phi))/F < 0.2$ for the final iteration of the safety factor calculation. This screens out some slip surfaces which may not be valid in the context of the analysis, in particular, deep

 BYER GEOTECHNICAL INC.	<i>Project</i> BG 21898 HARVARD-WESTLAKE SECTION 5		
	<i>Analysis Description</i> CALCULATE THE SEISMIC STABILITY OF TRIALS BELOW THE SOIL NAILS		
	<i>Drawn By</i> R. ZWEIGLER	<i>Scale</i>	<i>Company</i> BYER GEOTECHNICAL, INC.
	<i>Date</i> 4/17/15	<i>File Name</i> 21898 Section 5 Below soil nails EQ updated.slim	
<small>SLIDEINTERPRET 6.035</small>			

seated slip surfaces with many high negative base angle slices in the passive zone.

-200 = Factor of Safety <= min iteration value. Could mean 0 Normal/Shear resistance along part of the slip surface

Slice Data

Global Minimum Query (janbu corrected) - Safety Factor: 1.24036

Slice Number	Width [ft]	Weight [lbs]	Base Material	Base Cohesion [psf]	Base Friction Angle [degrees]	Shear Stress [psf]	Shear Strength [psf]	Base Normal Stress [psf]	Pore Pressure [psf]	Effective Normal Stress [psf]
1	22.7769	13332.5	Bedrock	700	23	658.852	817.214	276.139	0	276.139
2	22.7769	39997.4	Bedrock	700	23	1004.05	1245.38	1284.83	0	1284.83
3	22.7769	66662.3	Bedrock	700	23	1349.24	1673.55	2293.53	0	2293.53
4	22.7769	93327.2	Bedrock	700	23	1694.44	2101.71	3302.22	0	3302.22
5	22.7769	119992	Bedrock	700	23	2039.63	2529.88	4310.91	0	4310.91
6	22.7769	146657	Bedrock	700	23	2384.82	2958.04	5319.59	0	5319.59
7	22.7769	173322	Bedrock	700	23	2730.02	3386.21	6328.32	0	6328.32
8	22.7769	194008	Bedrock	700	23	2997.81	3718.36	7110.82	0	7110.82
9	22.7769	203073	Bedrock	700	23	3115.16	3863.92	7453.72	0	7453.72
10	22.7769	211907	Bedrock	700	23	3229.53	4005.78	7787.93	0	7787.93
11	22.7769	224263	Bedrock	700	23	3389.48	4204.18	8255.34	0	8255.34
12	22.7769	241287	Bedrock	700	23	3609.87	4477.54	8899.35	0	8899.35
13	22.7769	252792	Bedrock	700	23	3758.8	4662.27	9334.53	0	9334.53
14	22.7769	261819	Bedrock	700	23	3875.67	4807.23	9676.04	0	9676.04
15	22.7769	280645	Bedrock	700	23	4119.38	5109.52	10388.2	0	10388.2
16	22.7769	304924	Bedrock	700	23	4433.69	5499.37	11306.6	0	11306.6
17	22.7769	329202	Bedrock	700	23	4747.98	5889.21	12225	0	12225
18	21.1045	310113	Bedrock	825	37	10729.9	13308.9	16566.6	0	16566.6
19	21.1045	286717	Bedrock	825	37	9976.46	12374.4	15326.6	0	15326.6
20	21.1045	249706	Bedrock	825	37	8784.71	10896.2	13365	0	13365
21	21.1045	210429	Bedrock	825	37	7519.96	9327.46	11283.2	0	11283.2
22	21.1045	149596	Bedrock	825	37	5561.11	6897.78	8058.84	0	8058.84
23	21.1045	56866.1	Bedrock	825	37	2575.14	3194.1	3143.9	0	3143.9
24	21.1045	12769.2	Bedrock	825	37	1155.19	1432.85	806.641	0	806.641
25	21.1045	4256.39	Bedrock	825	37	881.071	1092.85	355.442	0	355.442

Interslice Data

Global Minimum Query (janbu corrected) - Safety Factor: 1.24036

Slice Number	X coordinate [ft]	Y coordinate [ft]	Interslice Bottom	Interslice Normal Force [lbs]	Interslice Shear Force [lbs]	Interslice Force Angle [degrees]
1	-393.597	865		0	0	0
2	-370.82	854.82		-9080.32	0	0
3	-348.043	844.64		-8415.34	0	0

 BYER GEOTECHNICAL INC.	Project			BG 21898 HARVARD-WESTLAKE SECTION 5			
	Analysis Description						CALCULATE THE SEISMIC STABILITY OF TRIALS BELOW THE SOIL NAILS
	Drawn By			R. ZWEIGLER	Scale		Company
	Date			4/17/15	File Name		21898 Section 5 Below soil nails EQ updated.slim

4	-325.267	834.46	1994.92	0	0
5	-302.49	824.28	22150.5	0	0
6	-279.713	814.1	52051.3	0	0
7	-256.936	803.92	91697.5	0	0
8	-234.159	793.74	141089	0	0
9	-211.382	783.56	198040	0	0
10	-188.605	773.38	258305	0	0
11	-165.828	763.2	321798	0	0
12	-143.051	753.02	389807	0	0
13	-120.274	742.84	464038	0	0
14	-97.4976	732.66	542473	0	0
15	-74.7207	722.48	624208	0	0
16	-51.9438	712.3	712823	0	0
17	-29.1669	702.12	810311	0	0
18	-6.39	691.94	916673	0	0
19	14.7145	695.448	710714	0	0
20	35.8191	698.955	519014	0	0
21	56.9236	702.463	349874	0	0
22	78.0281	705.97	204673	0	0
23	99.1327	709.478	96549.3	0	0
24	120.237	712.985	44945.6	0	0
25	141.342	716.493	20219.2	0	0
26	162.446	720	0	0	0

List Of Coordinates

External Boundary

X	Y
103	762
86	762
84	784
75	785
69	790
62	795
53	800
44	805
34	810
26	815
18	820
0	822
-75	825
-97	830
-110	835

 <p>BYER GEOTECHNICAL INC.</p>	<i>Project</i> BG 21898 HARVARD-WESTLAKE SECTION 5		
	<i>Analysis Description</i> CALCULATE THE SEISMIC STABILITY OF TRIALS BELOW THE SOIL NAILS		
	<i>Drawn By</i> R. ZWEIGLER	<i>Scale</i>	<i>Company</i> BYER GEOTECHNICAL, INC.
	<i>Date</i> 4/17/15		<i>File Name</i> 21898 Section 5 Below soil nails EQ updated.slim

-130	840
-163	845
-180	850
-230	865
-400	865
-400	675
217	675
217	720
110	720



BYER
GEOTECHNICAL
INC.

SLIDEINTERPRET 6.035

<i>Project</i>			
BG 21898 HARVARD-WESTLAKE SECTION 5			
<i>Analysis Description</i>			
CALCULATE THE SEISMIC STABILITY OF TRIALS BELOW THE SOIL NAILS			
<i>Drawn By</i>	R. ZWEIGLER	<i>Scale</i>	<i>Company</i>
			BYER GEOTECHNICAL, INC.
<i>Date</i>	4/17/15	<i>File Name</i>	21898 Section 5 Below soil nails EQ updated.slim

BG 21898 HARVARD WESTLAKE SECTION 5

DETERMINE THE FAILURE SURFACE WITH THE LOWEST FACTOR OF SAFETY TO DEFINE THE ACTIVE WEDGE.

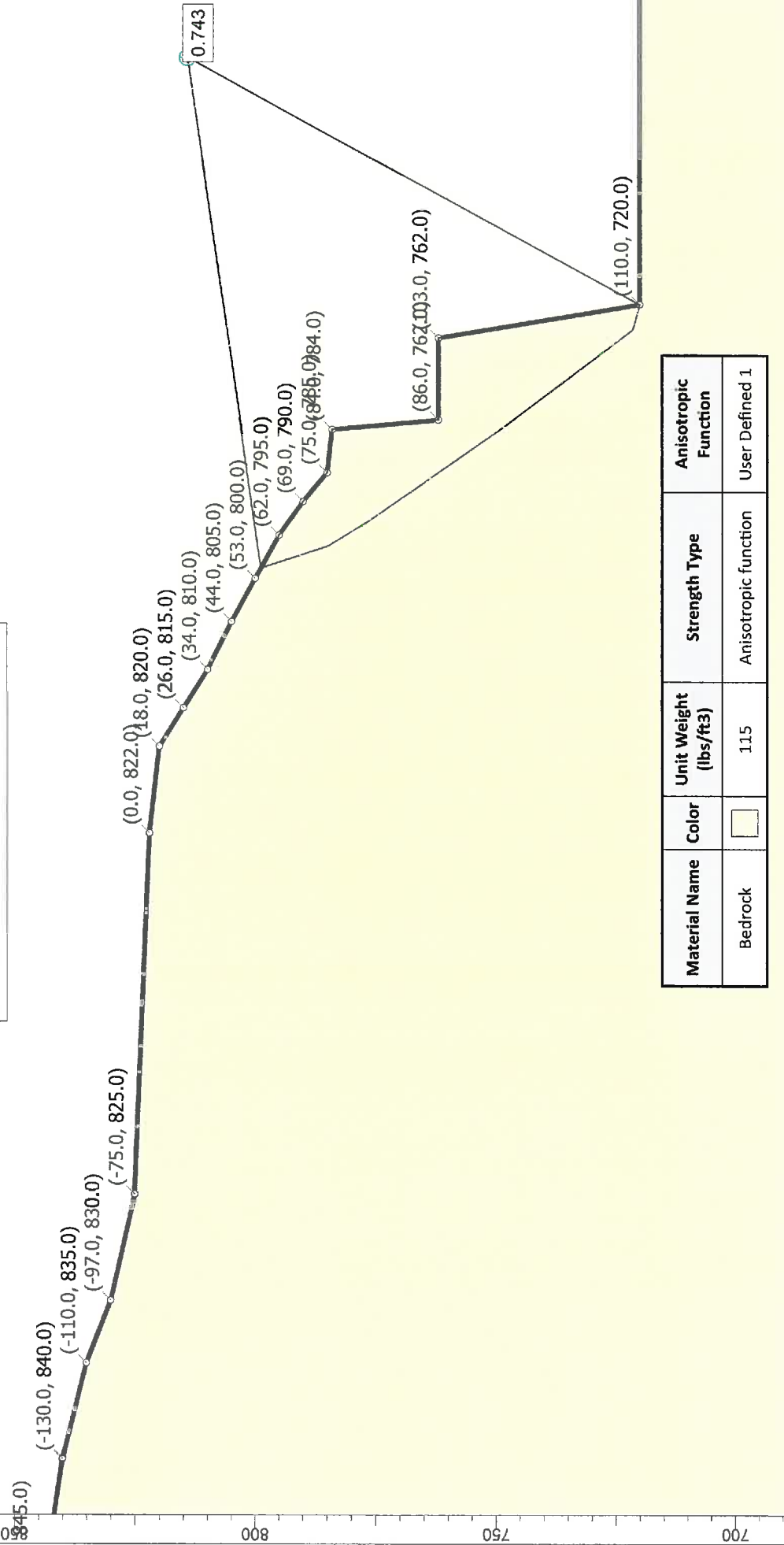

Material Name	Color	Unit Weight (lbs/ft ³)	Strength Type	Anisotropic Function
Bedrock	<input type="checkbox"/>	115	Anisotropic function	User Defined 1

BYER GEOTECHNICAL INC.		BG 21898 HARVARD-WESTLAKE SECTION 5	
		Project BG 21898 HARVARD-WESTLAKE SECTION 5	
CALCULATE THE LOCATION OF THE MOST CRITICAL FAILURE THROUGH THE SOIL NAIL WALLS			
Analysis Description R. ZWEIGLER		Scale 1:379	
Drawn By R. ZWEIGLER		Company BYER GEOTECHNICAL, INC.	
Date 5/18/15		File Name 21898 Section 5 active wedge ver 2.slim	

Slide Analysis Information

BG 21898 HARVARD-WESTLAKE SECTION 5

Project Summary

File Name: 21898 Section 5 active wedge ver 2
Slide Modeler Version: 6.035
Project Title: BG 21898 HARVARD-WESTLAKE SECTION 5
Analysis: CALCULATE THE LOCATION OF THE MOST CRITICAL FAILURE THROUGH THE SOIL NAIL WALLS
Author: R. ZWEIGLER
Company: BYER GEOTECHNICAL, INC.
Date Created: 5/18/15

General Settings

Units of Measurement: Imperial Units
Time Units: days
Permeability Units: feet/second
Failure Direction: Left to Right
Data Output: Standard
Maximum Material Properties: 20
Maximum Support Properties: 20

Analysis Options

Analysis Methods Used

Janbu corrected

Number of slices: 25
Tolerance: 0.005
Maximum number of iterations: 50
Check malpha < 0.2: Yes
Initial trial value of FS: 1
Steffensen Iteration: Yes

Groundwater Analysis

Groundwater Method: Water Surfaces
Pore Fluid Unit Weight: 62.4 lbs/ft³
Advanced Groundwater Method: None

Random Numbers

 BYER GEOTECHNICAL INC.	<i>Project</i> BG 21898 HARVARD-WESTLAKE SECTION 5		
	<i>Analysis Description</i> CALCULATE THE LOCATION OF THE MOST CRITICAL FAILURE THROUGH THE SOIL NAIL WALLS		
	<i>Drawn By</i> R. ZWEIGLER	<i>Scale</i>	<i>Company</i> BYER GEOTECHNICAL, INC.
	<i>Date</i> 5/18/15	<i>File Name</i> 21898 Section 5 active wedge ver 2.slim	
SLIDEINTERPRET 6.035			

Surface Options

Material Properties

Property	Bedrock
Color	<input type="checkbox"/>
Strength Type	Anisotropic function
Unit Weight [lbs/ft3]	115
Water Surface	None
Ru Value	0

Anisotropic Functions

Name: User Defined 1

Angle From	Angle To	c	phi
-90	-65	540	36
-65	-53	510	19.5
-53	-27	540	36
-27	-15	510	19.5
-15	90	540	36

Global Minimums

Method: janbu corrected

FS: 0.742970
 Axis Location: 161.383, 814.317
 Left Slip Surface Endpoint: 55.100, 798.834
 Right Slip Surface Endpoint: 110.000, 720.000
 Resisting Horizontal Force=47796.5 lb
 Driving Horizontal Force=64331.7 lb
 Total Slice Area=1207.36 ft²

Global Minimum Coordinates

Method: janbu corrected

X	Y
55.0996	798.834
59.5976	785.004

 BYER GEOTECHNICAL INC.	Project			BG 21898 HARVARD-WESTLAKE SECTION 5	
	Analysis Description				CALCULATE THE LOCATION OF THE MOST CRITICAL FAILURE THROUGH THE SOIL NAIL WALLS
	Drawn By	R. ZWEIGLER	Scale	Company	BYER GEOTECHNICAL, INC.
	Date	5/18/15	File Name	21898 Section 5 active wedge ver 2.slim	
SLIDEINTERPRET 6.035					

64.8738	776.534
83.1645	750.27
84.862	747.89
96.7602	732.101
104.786	721.45
110	720

Valid / Invalid Surfaces

Method: janbu corrected

Number of Valid Surfaces: 1

Number of Invalid Surfaces: 0

Slice Data

Global Minimum Query (janbu corrected) - Safety Factor: 0.74297

Slice Number	Width [ft]	Weight [lbs]	Base Material	Base Cohesion [psf]	Base Friction Angle [degrees]	Shear Stress [psf]	Shear Strength [psf]	Base Normal Stress [psf]	Pore Pressure [psf]	Effective Normal Stress [psf]
1	2.24899	732.596	Bedrock	540	36	256.507	190.577	-480.94	0	-480.94
2	2.24899	2197.79	Bedrock	540	36	412.832	306.722	-321.079	0	-321.079
3	2.6381	3857	Bedrock	510	19.5	775.949	576.507	187.81	0	187.81
4	2.6381	4622.89	Bedrock	510	19.5	853.569	634.176	350.663	0	350.663
5	2.28633	4532.42	Bedrock	510	19.5	959.546	712.914	573.01	0	573.01
6	2.28633	4964.87	Bedrock	510	19.5	1012.57	752.312	684.268	0	684.268
7	2.28633	5350.29	Bedrock	510	19.5	1059.84	787.426	783.425	0	783.425
8	2.28633	5712.54	Bedrock	510	19.5	1104.26	820.429	876.624	0	876.624
9	2.28633	6145.57	Bedrock	510	19.5	1157.35	859.88	988.029	0	988.029
10	2.28633	6902.03	Bedrock	510	19.5	1250.11	928.797	1182.65	0	1182.65
11	2.28633	7698.43	Bedrock	510	19.5	1347.77	1001.35	1387.54	0	1387.54
12	2.28633	8494.84	Bedrock	510	19.5	1445.43	1073.91	1592.43	0	1592.43
13	1.69747	6351.23	Bedrock	510	19.5	1467.07	1089.99	1637.84	0	1637.84
14	1.98303	4337	Bedrock	510	19.5	1049.7	779.897	762.165	0	762.165
15	1.98303	4117.95	Bedrock	510	19.5	1017.73	756.146	695.095	0	695.095
16	1.98303	4718.07	Bedrock	510	19.5	1105.31	821.215	878.844	0	878.844
17	1.98303	5318.2	Bedrock	510	19.5	1192.89	886.284	1062.59	0	1062.59
18	1.98303	5918.33	Bedrock	510	19.5	1280.47	951.353	1246.34	0	1246.34
19	1.98303	6518.46	Bedrock	510	19.5	1368.05	1016.42	1430.09	0	1430.09
20	2.00654	7206.58	Bedrock	510	19.5	1456.15	1081.88	1614.93	0	1614.93
21	2.00654	7821.03	Bedrock	510	19.5	1544.77	1147.72	1800.86	0	1800.86
22	2.00654	8435.47	Bedrock	510	19.5	1633.39	1213.56	1986.78	0	1986.78
23	2.00654	7949.01	Bedrock	510	19.5	1563.23	1161.43	1839.58	0	1839.58
24	2.60683	6707.5	Bedrock	510	19.5	1684.49	1251.53	2094.01	0	2094.01

 BYER GEOTECHNICAL INC.	Project			BG 21898 HARVARD-WESTLAKE SECTION 5											
	Analysis Description						CALCULATE THE LOCATION OF THE MOST CRITICAL FAILURE THROUGH THE SOIL NAIL WALLS								
	Drawn By			R. ZWEIGLER			Scale			Company			BYER GEOTECHNICAL, INC.		
	Date						5/18/15			File Name			21898 Section 5 active wedge ver 2.slim		
SLIDEINTERPRET 6.035															

Interslice Data

Global Minimum Query (Janbu corrected) - Safety Factor: 0.74297

Slice Number	X coordinate [ft]	Y coordinate - Bottom [ft]	Interslice Normal Force [lbs]	Interslice Shear Force [lbs]	Interslice Force Angle [degrees]
1	55.0996	798.834	0	0	0
2	57.3486	791.919	-3915.57	0	0
3	59.5976	785.004	-7085.4	0	0
4	62.2357	780.769	-8383.88	0	0
5	64.8738	776.534	-9202.09	0	0
6	67.1602	773.251	-9564.94	0	0
7	69.4465	769.968	-9686.54	0	0
8	71.7328	766.685	-9593.13	0	0
9	74.0192	763.402	-9297.63	0	0
10	76.3055	760.119	-8760.57	0	0
11	78.5918	756.836	-7801.5	0	0
12	80.8782	753.553	-6398.15	0	0
13	83.1645	750.27	-4550.52	0	0
14	84.862	747.89	-3200.31	0	0
15	86.845	745.258	-3323.86	0	0
16	88.828	742.627	-3559.07	0	0
17	90.8111	739.995	-3488.37	0	0
18	92.7941	737.364	-3111.77	0	0
19	94.7771	734.732	-2429.28	0	0
20	96.7602	732.101	-1440.88	0	0
21	98.7667	729.438	-129.399	0	0
22	100.773	726.775	1495.28	0	0
23	102.78	724.112	3433.15	0	0
24	104.786	721.45	5123.06	0	0
25	107.393	720.725	2149.01	0	0
26	110	720	0	0	0

List Of Coordinates

External Boundary

X	Y
103	762
86	762
84	784
75	785

 BYER GEOTECHNICAL INC.	<i>Project</i> BG 21898 HARVARD-WESTLAKE SECTION 5		
	<i>Analysis Description</i> CALCULATE THE LOCATION OF THE MOST CRITICAL FAILURE THROUGH THE SOIL NAIL WALLS		
	<i>Drawn By</i> R. ZWEIGLER	<i>Scale</i>	<i>Company</i> BYER GEOTECHNICAL, INC.
	<i>Date</i> 5/18/15		<i>File Name</i> 21898 Section 5 active wedge ver 2.slim

69	790
62	795
53	800
44	805
34	810
26	815
18	820
0	822
-75	825
-97	830
-110	835
-130	840
-163	845
-180	850
-230	865
-400	865
-400	675
217	675
217	720
110	720



BYER
GEOTECHNICAL
INC.

<i>Project</i>			
BG 21898 HARVARD-WESTLAKE SECTION 5			
<i>Analysis Description</i>			
CALCULATE THE LOCATION OF THE MOST CRITICAL FAILURE THROUGH THE SOIL NAIL WALLS			
<i>Drawn By</i>	R. ZWEIGLER	<i>Scale</i>	<i>Company</i>
			BYER GEOTECHNICAL, INC.
<i>Date</i>	5/18/15	<i>File Name</i>	21898 Section 5 active wedge ver 2.slim

BG 21898 HARVARD WESTLAKE SECTION 5

CALCULATE THE MINIMUM REQUIRED EFP APPLIED TO THE FACE OF THE PROPOSED SOIL NAIL CONFIGURATION TO ACHIEVE A FACTOR OF SAFETY OF 1.5.

THE RESULTS INDICATE THAT AN EFP OF 85 POUNDS PER CUBIC FOOT WILL ACHIEVE A FACTOR OF SAFETY OF 1.5.

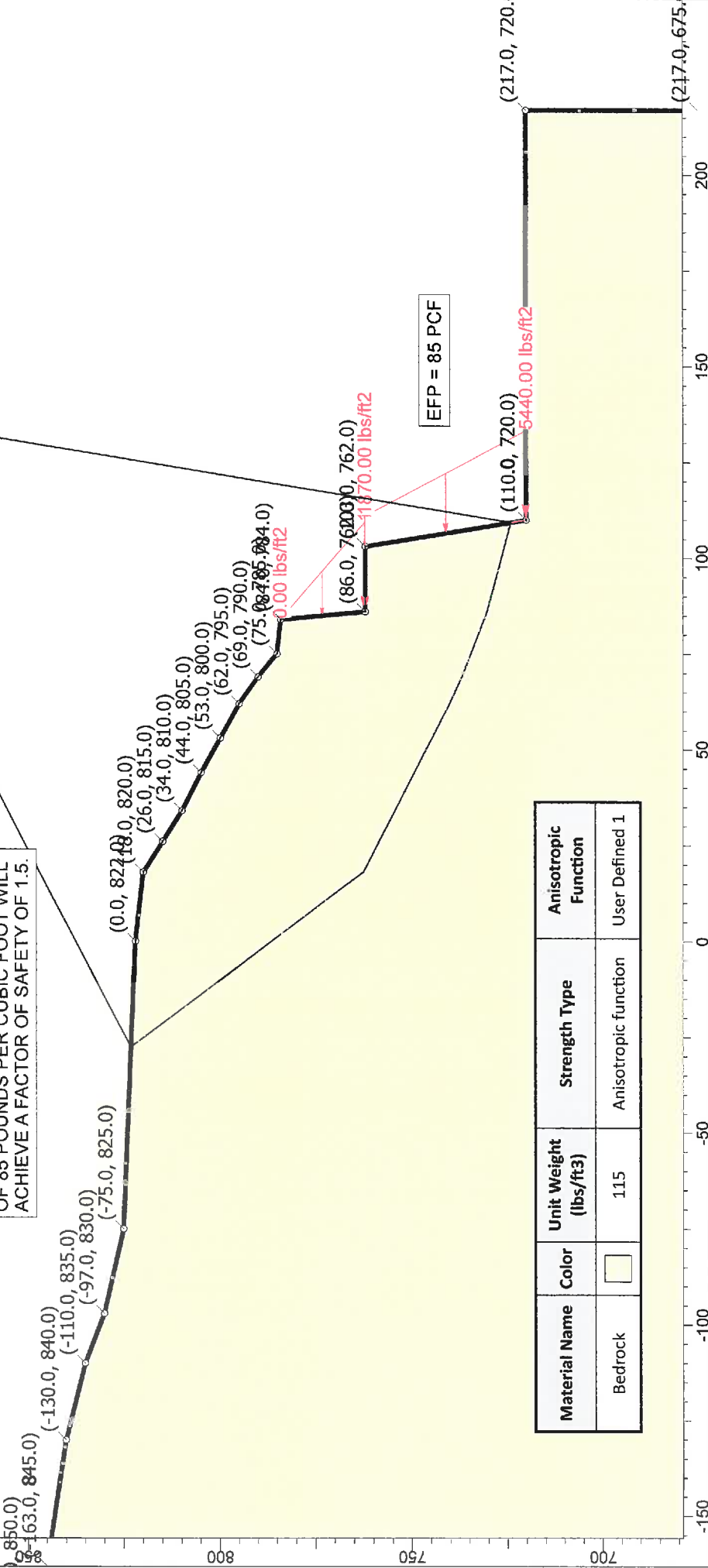

Material Name	Color	Unit Weight (lbs/ft ³)	Strength Type	Anisotropic Function
Bedrock	<input type="checkbox"/>	115	Anisotropic function	User Defined 1

BG 21898 HARVARD-WESTLAKE SECTION 5

Analysis Description		CALCULATE THE MINIMUM REQUIRED EFP APPLIED TO SOIL NAIL WALLS TO ACHIEVE FS=1.5	
Drawn By	R. ZWEIGLER	Scale	1:468
Date	5/18/15	Company	BYER GEOTECHNICAL, INC.
		File Name	21898 Section 5 efp.slm



Slide Analysis Information

BG 21898 HARVARD-WESTLAKE SECTION 5

Project Summary

File Name: 21898 Section 5 efp
Slide Modeler Version: 6.035
Project Title: BG 21898 HARVARD-WESTLAKE SECTION 5
Analysis: CALCULATE THE MINIMUM REQUIRED EFP APPLIED TO SOIL NAIL WALLS TO ACHIEVE FS=1.5
Author: R. ZWEIGLER
Company: BYER GEOTECHNICAL, INC.
Date Created: 5/18/15

General Settings

Units of Measurement: Imperial Units
Time Units: days
Permeability Units: feet/second
Failure Direction: Left to Right
Data Output: Standard
Maximum Material Properties: 20
Maximum Support Properties: 20

Analysis Options

Analysis Methods Used

Spencer

Number of slices: 25
Tolerance: 0.005
Maximum number of iterations: 50
Check $m\alpha < 0.2$: Yes
Initial trial value of FS: 1
Steffensen Iteration: Yes

Groundwater Analysis

Groundwater Method: Water Surfaces
Pore Fluid Unit Weight: 62.4 lbs/ft³
Advanced Groundwater Method: None

Random Numbers

 BYER GEOTECHNICAL INC.	<i>Project</i> BG 21898 HARVARD-WESTLAKE SECTION 5		
	<i>Analysis Description</i> CALCULATE THE MINIMUM REQUIRED EFP APPLIED TO SOIL NAIL WALLS TO ACHIEVE FS=1.5		
	<i>Drawn By</i> R. ZWEIGLER	<i>Scale</i>	<i>Company</i> BYER GEOTECHNICAL, INC.
	<i>Date</i> 5/18/15	<i>File Name</i> 21898 Section 5 efp.slim	

SLIDEINTERPRET 6.035

Surface Options

Loading

2 Distributed Loads present

Distributed Load 1

Distribution: Triangular
 Magnitude 1 [psf]: 1870
 Magnitude 2 [psf]: 0
 Orientation: Horizontal

Distributed Load 2

Distribution: Triangular
 Magnitude 1 [psf]: 5440
 Magnitude 2 [psf]: 1870
 Orientation: Horizontal

Material Properties

Property	Bedrock
Color	<input type="checkbox"/>
Strength Type	Anisotropic function
Unit Weight [lbs/ft ³]	115
Water Surface	None
Ru Value	0

Anisotropic Functions

Name: User Defined 1

Angle From	Angle To	c	phi
-90	-65	540	36
-65	-53	510	19.5
-53	-27	540	36
-27	-15	510	19.5
-15	90	540	36

Global Minimums

 BYER GEOTECHNICAL INC.	<i>Project</i> BG 21898 HARVARD-WESTLAKE SECTION 5		
	<i>Analysis Description</i> CALCULATE THE MINIMUM REQUIRED EFP APPLIED TO SOIL NAIL WALLS TO ACHIEVE FS=1.5		
	<i>Drawn By</i> R. ZWEIGLER	<i>Scale</i>	<i>Company</i> BYER GEOTECHNICAL, INC.
	<i>Date</i> 5/18/15	<i>File Name</i> 21898 Section 5 efp.slim	

Method: spencer

FS: 1.650350
Axis Location: 139.906, 910.498
Left Slip Surface Endpoint: -27.592, 823.104
Right Slip Surface Endpoint: 109.323, 724.063
Resisting Moment=6.03918e+007 lb-ft
Driving Moment=3.65934e+007 lb-ft
Resisting Horizontal Force=267557 lb
Driving Horizontal Force=162122 lb
Total Slice Area=5712.48 ft2

Global Minimum Coordinates

Method: spencer

X	Y
-27.5918	823.104
-12.2058	802.686
18.0912	762.48
20.2522	761.379
61.0471	740.593
69.4692	736.759
86	730.313
109.323	724.063

Valid / Invalid Surfaces

Method: spencer

Number of Valid Surfaces: 1
Number of Invalid Surfaces: 0

Slice Data

Global Minimum Query (spencer) - Safety Factor: 1.65035

Slice Number	Width [ft]	Weight [lbs]	Base Material	Base Cohesion [psf]	Base Friction Angle [degrees]	Shear Stress [psf]	Shear Strength [psf]	Base Normal Stress [psf]	Pore Pressure [psf]	Effective Normal Stress [psf]
1	5.12866	1946.57	Bedrock	510	19.5	316.128	521.722	33.1013	0	33.1013
2	5.12866	5839.71	Bedrock	510	19.5	418.997	691.491	512.514	0	512.514
3	5.12866	9732.85	Bedrock	510	19.5	521.864	861.259	991.926	0	991.926
4	5.0495	13386.1	Bedrock	510	19.5	623.939	1029.72	1467.63	0	1467.63
5	5.0495	17160	Bedrock	510	19.5	725.219	1196.87	1939.65	0	1939.65
6	5.0495	20898.4	Bedrock	510	19.5	825.55	1362.45	2407.24	0	2407.24

 BYER GEOTECHNICAL INC.	Project		BG 21898 HARVARD-WESTLAKE SECTION 5					
	Analysis Description				CALCULATE THE MINIMUM REQUIRED EFP APPLIED TO SOIL NAIL WALLS TO ACHIEVE FS=1.5			
	Drawn By		R. ZWEIGLER	Scale	Company		BYER GEOTECHNICAL, INC.	
	Date			5/18/15		File Name		21898 Section 5 efp.slim

7	5.0495	24481.9	Bedrock	510	19.5	921.72	1521.16	2855.44	0	2855.44
8	5.0495	28047.3	Bedrock	510	19.5	1017.41	1679.08	3301.37	0	3301.37
9	5.0495	31612.4	Bedrock	510	19.5	1113.09	1836.98	3747.27	0	3747.27
10	2.16107	14249.8	Bedrock	510	19.5	1486.02	2452.46	5485.34	0	5485.34
11	5.82784	38118.8	Bedrock	510	19.5	1476.44	2436.65	5440.7	0	5440.7
12	5.82784	37667.8	Bedrock	510	19.5	1462.47	2413.59	5375.57	0	5375.57
13	5.82784	37317.1	Bedrock	510	19.5	1451.61	2395.66	5324.95	0	5324.95
14	5.82784	37322.8	Bedrock	510	19.5	1451.79	2395.96	5325.78	0	5325.78
15	5.82784	37267.2	Bedrock	510	19.5	1450.06	2393.11	5317.74	0	5317.74
16	5.82784	37088	Bedrock	510	19.5	1444.51	2383.95	5291.87	0	5291.87
17	5.82784	36908.2	Bedrock	510	19.5	1438.94	2374.76	5265.92	0	5265.92
18	8.42215	52288.7	Bedrock	510	19.5	1444.49	2383.92	5291.78	0	5291.78
19	5.51025	32716.1	Bedrock	510	19.5	1428.58	2357.65	5217.61	0	5217.61
20	5.51025	32419.4	Bedrock	510	19.5	1418.36	2340.79	5170	0	5170
21	5.51025	30888.4	Bedrock	510	19.5	1556.58	2568.91	5814.2	0	5814.2
22	5.83069	21771	Bedrock	510	19.5	1056.55	1743.68	3483.81	0	3483.81
23	5.83069	22818.6	Bedrock	510	19.5	1092.52	1803.04	3651.43	0	3651.43
24	5.83069	23782.7	Bedrock	510	19.5	1180.67	1948.52	4062.26	0	4062.26
25	5.83069	11205.2	Bedrock	510	19.5	1873.14	3091.33	7289.46	0	7289.46

Interslice Data

Global Minimum Query (spencer) - Safety Factor: 1.65035

Slice Number	X coordinate [ft]	Y coordinate - Bottom [ft]	Interslice Normal Force [lbs]	Interslice Shear Force [lbs]	Interslice Force Angle [degrees]
1	-27.5918	823.104	0	0	0
2	-22.4631	816.298	-1396.03	-374.758	15.0265
3	-17.3345	809.492	-56.7792	-15.2421	15.0265
4	-12.2058	802.686	4017.76	1078.55	15.0265
5	-7.15631	795.985	10701.7	2872.81	15.0265
6	-2.10682	789.284	20037.1	5378.86	15.0265
7	2.94268	782.583	31999.1	8590.01	15.0265
8	7.99218	775.882	46478.9	12477	15.0265
9	13.0417	769.181	63463.7	17036.5	15.0265
10	18.0912	762.48	82953.3	22268.4	15.0265
11	20.2522	761.379	85781.9	23027.7	15.0265
12	26.0801	758.41	93333.1	25054.8	15.0265
13	31.9079	755.44	100772	27051.9	15.0266
14	37.7358	752.471	108125	29025.6	15.0265
15	43.5636	749.501	115479	30999.6	15.0264
16	49.3914	746.532	122818	32970	15.0266
17	55.2193	743.563	130114	34928.4	15.0265
18	61.0471	740.593	137365	36874.9	15.0265

 BYER GEOTECHNICAL INC.	Project			
	BG 21898 HARVARD-WESTLAKE SECTION 5			
	Analysis Description			
	CALCULATE THE MINIMUM REQUIRED EFP APPLIED TO SOIL NAIL WALLS TO ACHIEVE FS=1.5			
Drawn By	R. ZWEIGLER	Scale	Company	BYER GEOTECHNICAL, INC.
Date	5/18/15		File Name	21898 Section 5 efp.slim

19	69.4692	736.759	145491	39056.4	15.0265
20	74.9795	734.61	148830	39952.6	15.0265
21	80.4898	732.461	152122	40836.5	15.0265
22	86	730.313	135383	36342.8	15.0265
23	91.8307	728.75	134665	36150.2	15.0265
24	97.6614	727.188	134000	35971.6	15.0265
25	103.492	725.626	127489	34223.9	15.0265
26	109.323	724.063	0	0	0

List Of Coordinates

Distributed Load

X	Y
86	762
84	784

Distributed Load

X	Y
110	720
103	762

External Boundary

X	Y
103	762
86	762
84	784
75	785
69	790
62	795
53	800
44	805
34	810
26	815
18	820
0	822
-75	825
-97	830
-110	835
-130	840
-163	845
-180	850

 <p>BYER GEOTECHNICAL INC.</p>	<i>Project</i> BG 21898 HARVARD-WESTLAKE SECTION 5		
	<i>Analysis Description</i> CALCULATE THE MINIMUM REQUIRED EFP APPLIED TO SOIL NAIL WALLS TO ACHIEVE FS=1.5		
	<i>Drawn By</i> R. ZWEIGLER	<i>Scale</i>	<i>Company</i> BYER GEOTECHNICAL, INC.
	<i>Date</i> 5/18/15		<i>File Name</i> 21898 Section 5 efp.slim

-230	865
-400	865
-400	675
217	675
217	720
110	720

 BYER GEOTECHNICAL INC.	<i>Project</i>			BG 21898 HARVARD-WESTLAKE SECTION 5	
	<i>Analysis Description</i>				
	CALCULATE THE MINIMUM REQUIRED EFP APPLIED TO SOIL NAIL WALLS TO ACHIEVE FS=1.5				
	<i>Drawn By</i>	R. ZWEIGLER	<i>Scale</i>	<i>Company</i>	BYER GEOTECHNICAL, INC.
<i>Date</i>	5/18/15		<i>File Name</i>	21898 Section 5 efp.slim	

BG 21898 HARVARD WESTLAKE SECTION 5

CALCULATE THE MINIMUM REQUIRED EFP APPLIED TO THE FACE OF THE PROPOSED SOIL NAIL CONFIGURATION TO ACHIEVE A FACTOR OF SAFETY OF 1.0 UNDER SEISMIC LOADING.

NOTE: THE SEARCH WAS LIMITED TO THE UPSLOPE DISTANCE RESULTING IN THE MOST CRITICAL FAILURE UNDER STATIC CONDITIONS.

THE RESULTS INDICATE THAT AN EFP OF 110 PCF WILL ACHIEVE A FACTOR OF SAFETY IN EXCESS OF 1.0.

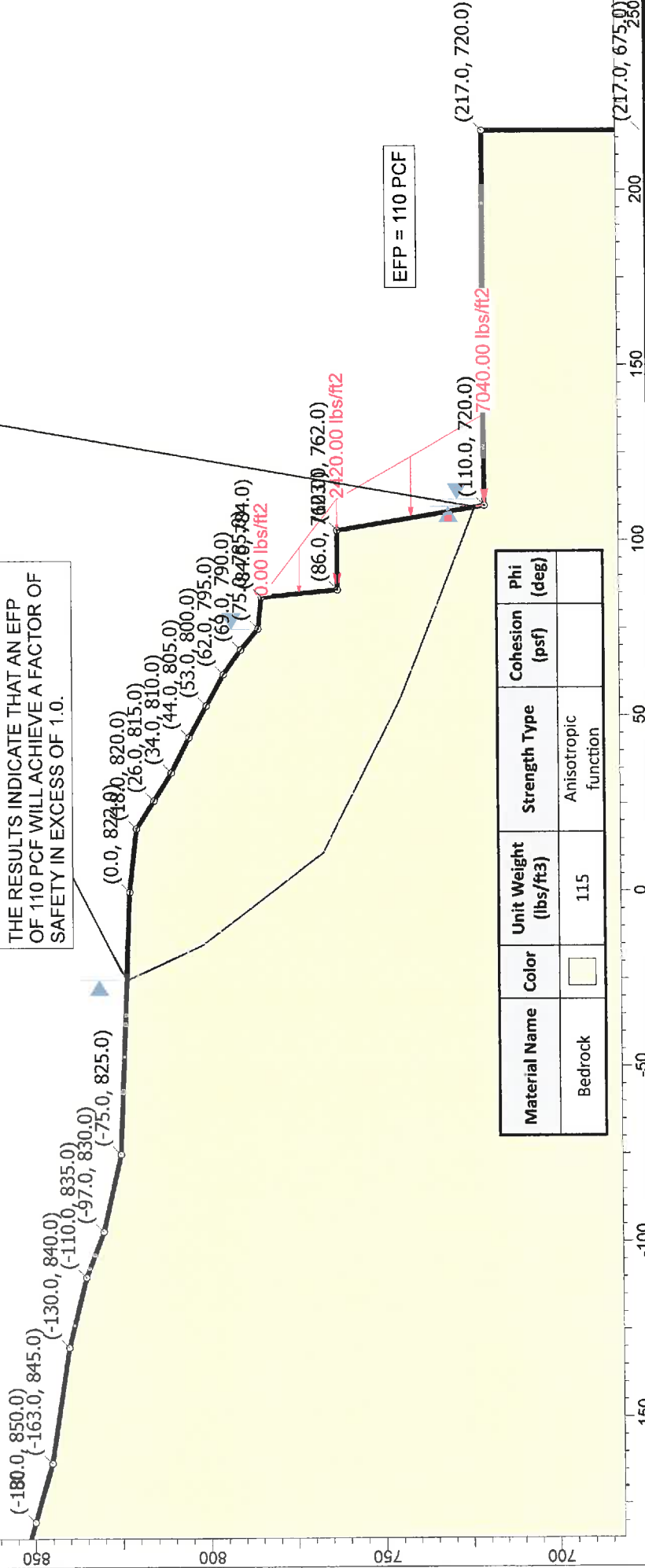

EFP = 110 PCF

Material Name	Color	Unit Weight (lbs/ft ³)	Strength Type	Cohesion (psf)	Phi (deg)
Bedrock	[White Box]	115	Anisotropic function		

BG 21898 HARVARD-WESTLAKE SECTION 5

Project



Analysis Description: CALCULATE THE MINIMUM REQUIRED EFP APPLIED TO SOIL NAIL WALLS TO ACHIEVE FS=1.0 (SEISMIC)

Company: BYER GEOTECHNICAL, INC.

Scale: 1:520

Drawn By: R. ZWEIGLER

Date: 5/18/15

File Name: 21898 Section 5 efp EQ.slim

Slide Analysis Information

BG 21898 HARVARD-WESTLAKE SECTION 5

Project Summary

File Name: 21898 Section 5 efp EQ
Slide Modeler Version: 6.035
Project Title: BG 21898 HARVARD-WESTLAKE SECTION 5
Analysis: CALCULATE THE MINIMUM REQUIRED EFP APPLIED TO SOIL NAIL WALLS TO ACHIEVE FS=1.0 (SEISMIC)
Author: R. ZWEIGLER
Company: BYER GEOTECHNICAL, INC.
Date Created: 5/18/15

General Settings

Units of Measurement: Imperial Units
Time Units: days
Permeability Units: feet/second
Failure Direction: Left to Right
Data Output: Standard
Maximum Material Properties: 20
Maximum Support Properties: 20

Analysis Options

Analysis Methods Used

Spencer

Number of slices: 25
Tolerance: 0.005
Maximum number of iterations: 50
Check $\alpha < 0.2$: Yes
Initial trial value of FS: 1
Steffensen Iteration: Yes

Groundwater Analysis

Groundwater Method: Water Surfaces
Pore Fluid Unit Weight: 62.4 lbs/ft³
Advanced Groundwater Method: None

Random Numbers

 BYER GEOTECHNICAL INC.	<i>Project</i> BG 21898 HARVARD-WESTLAKE SECTION 5		
	<i>Analysis Description</i> CALCULATE THE MINIMUM REQUIRED EFP APPLIED TO SOIL NAIL WALLS TO ACHIEVE FS=1.0 (SEISMIC)		
	<i>Drawn By</i> R. ZWEIGLER	<i>Scale</i>	<i>Company</i> BYER GEOTECHNICAL, INC.
	<i>Date</i> 5/18/15	<i>File Name</i> 21898 Section 5 efp EQ.slim	
SLIDEINTERPRET 6.035			

Surface Options

Loading

Seismic Load Coefficient (Horizontal): 0.29
 2 Distributed Loads present

Distributed Load 1

Distribution: Triangular
 Magnitude 1 [psf]: 2420
 Magnitude 2 [psf]: 0
 Orientation: Horizontal

Distributed Load 2

Distribution: Triangular
 Magnitude 1 [psf]: 7040
 Magnitude 2 [psf]: 2420
 Orientation: Horizontal

Material Properties

Property	Bedrock
Color	<input type="checkbox"/>
Strength Type	Anisotropic function
Unit Weight [lbs/ft ³]	115
Water Surface	None
Ru Value	0

Anisotropic Functions

Name: User Defined 1

Angle From	Angle To	c	phi
-90	-65	827	37
-65	-53	510	19.5
-53	-27	827	37
-27	-15	510	19.5
-15	90	827	37

Global Minimums

 BYER GEOTECHNICAL INC.	Project BG 21898 HARVARD-WESTLAKE SECTION 5		
	Analysis Description CALCULATE THE MINIMUM REQUIRED EFP APPLIED TO SOIL NAIL WALLS TO ACHIEVE FS=1.0 (SEISMIC)		
	Drawn By R. ZWEIGLER	Scale	Company BYER GEOTECHNICAL, INC.
	Date 5/18/15		File Name 21898 Section 5 efp EQ.slim
SLIDEINTERPRET 6.035			

Method: spencer

FS: 1.000240
Axis Location: 142.293, 907.856
Left Slip Surface Endpoint: -25.420, 823.017
Right Slip Surface Endpoint: 109.536, 722.782
Resisting Moment=5.56936e+007 lb-ft
Driving Moment=5.56805e+007 lb-ft
Resisting Horizontal Force=253180 lb
Driving Horizontal Force=253121 lb
Total Slice Area=5797.83 ft²

Global Minimum Coordinates

Method: spencer

X	Y
-25.4201	823.017
-15.2894	801.489
10.9416	766.68
42.8289	750.432
55.5274	744.192
71.2501	737.96
98.5913	727.121
109.536	722.782

Valid / Invalid Surfaces

Method: spencer

Number of Valid Surfaces: 1
Number of Invalid Surfaces: 0

Slice Data

Global Minimum Query (spencer) - Safety Factor: 1.00024

Slice Number	Width [ft]	Weight [lbs]	Base Material	Base Cohesion [psf]	Base Friction Angle [degrees]	Shear Stress [psf]	Shear Strength [psf]	Base Normal Stress [psf]	Pore Pressure [psf]	Effective Normal Stress [psf]
1	5.06535	3076	Bedrock	510	19.5	470.995	471.108	-109.827	0	-109.827
2	5.06535	9228	Bedrock	510	19.5	605.263	605.408	269.424	0	269.424
3	5.2462	14780.1	Bedrock	510	19.5	860.927	861.134	991.571	0	991.571
4	5.2462	18853.7	Bedrock	510	19.5	977.405	977.64	1320.57	0	1320.57
5	5.2462	22926.5	Bedrock	510	19.5	1093.86	1094.12	1649.51	0	1649.51
6	5.2462	26869.1	Bedrock	510	19.5	1206.59	1206.88	1967.94	0	1967.94

 BYER GEOTECHNICAL INC.	Project		BG 21898 HARVARD-WESTLAKE SECTION 5		
	Analysis Description: THE MINIMUM REQUIRED EFP APPLIED TO SOIL NAIL WALLS TO ACHIEVE FS=1.0 (SETSMIC)				
	Drawn By	R. ZWEIGLER	Scale	Company	BYER GEOTECHNICAL, INC.
	Date	5/18/15		File Name	21898 Section 5 efp EQ.slim

7	5.2462	30717.7	Bedrock	510	19.5	1316.64	1316.95	2278.76	0	2278.76
8	5.31454	33714.3	Bedrock	510	19.5	2013.97	2014.45	4248.45	0	4248.45
9	5.31454	34631.6	Bedrock	510	19.5	2054.79	2055.28	4363.74	0	4363.74
10	5.31454	34346.4	Bedrock	510	19.5	2042.1	2042.59	4327.9	0	4327.9
11	5.31454	33971.3	Bedrock	510	19.5	2025.4	2025.89	4280.75	0	4280.75
12	5.31454	33685	Bedrock	510	19.5	2012.67	2013.15	4244.77	0	4244.77
13	5.31454	33692.7	Bedrock	510	19.5	2013.01	2013.49	4245.73	0	4245.73
14	6.34925	40165.3	Bedrock	510	19.5	2031.81	2032.3	4298.85	0	4298.85
15	6.34925	39872.2	Bedrock	510	19.5	2020.76	2021.24	4267.61	0	4267.61
16	5.24089	32537.8	Bedrock	510	19.5	2127.09	2127.6	4567.98	0	4567.98
17	5.24089	31888.5	Bedrock	510	19.5	2095.26	2095.76	4478.05	0	4478.05
18	5.24089	30863.6	Bedrock	510	19.5	2045.01	2045.5	4336.11	0	4336.11
19	5.46825	30917.8	Bedrock	510	19.5	1984.63	1985.11	4165.58	0	4165.58
20	5.46825	31315	Bedrock	510	19.5	2003.3	2003.78	4218.3	0	4218.3
21	5.46825	25664.7	Bedrock	510	19.5	2537	2537.61	5725.79	0	5725.79
22	5.46825	19888.9	Bedrock	510	19.5	1466.35	1466.71	2701.65	0	2701.65
23	5.46825	21252.1	Bedrock	510	19.5	1530.41	1530.78	2882.6	0	2882.6
24	5.4725	22242.9	Bedrock	510	19.5	2111.9	2112.41	4525.06	0	4525.06
25	5.4725	9649.49	Bedrock	510	19.5	5885.97	5887.38	15185.3	0	15185.3

Interslice Data

Global Minimum Query (spencer) - Safety Factor: 1.00024

Slice Number	X coordinate [ft]	Y coordinate - Bottom [ft]	Interslice Normal Force [lbs]	Interslice Shear Force [lbs]	Interslice Force Angle [degrees]
1	-25.4201	823.017	0	0	0
2	-20.3547	812.253	-2675.87	-1437.36	28.2427
3	-15.2894	801.489	-165.632	-88.9703	28.2428
4	-10.0432	794.527	6507.24	3495.4	28.2427
5	-4.79697	787.566	16040.9	8616.46	28.2427
6	0.449223	780.604	28434.7	15273.9	28.2428
7	5.69542	773.642	43597.4	23418.6	28.2427
8	10.9416	766.68	61462.8	33015.1	28.2427
9	16.2562	763.972	72040.9	38697.2	28.2427
10	21.5707	761.264	82980.3	44573.4	28.2428
11	26.8852	758.556	93807.4	50389.2	28.2427
12	32.1998	755.848	104487	56125.7	28.2427
13	37.5143	753.14	115053	61801.6	28.2428
14	42.8289	750.432	125623	67479.1	28.2427
15	49.1781	747.312	137783	74010.7	28.2427
16	55.5274	744.192	149830	80482.1	28.2427
17	60.7683	742.115	157608	84660.3	28.2428
18	66.0092	740.037	165179	88726.7	28.2427

 BYER GEOTECHNICAL INC.	Project			BG 21898 HARVARD-WESTLAKE SECTION 5		
	Analysis Description					TO ACHIEVE THE MINIMUM REQUIRED EFP APPLIED TO SOIL NAIL WALLS TO ACHIEVE FS=1.0 (SFTSMIC)
	Drawn By	R. ZWEIGLER	Scale	Company	BYER GEOTECHNICAL, INC.	
	Date	5/18/15		File Name	21898 Section 5 efp EQ.slim	

19	71.2501	737.96	172420	92616.5	28.2428
20	76.7183	735.792	179564	96453.7	28.2427
21	82.1866	733.624	186835	100359	28.2426
22	87.6548	731.456	166087	89214.4	28.2427
23	93.1231	729.289	169692	91151.3	28.2428
24	98.5913	727.121	173736	93323.1	28.2427
25	104.064	724.952	160514	86221	28.2427
26	109.536	722.782	0	0	0

List Of Coordinates

Distributed Load

X	Y
86	762
84	784

Distributed Load

X	Y
110	720
103	762

External Boundary

X	Y
103	762
86	762
84	784
75	785
69	790
62	795
53	800
44	805
34	810
26	815
18	820
0	822
-75	825
-97	830
-110	835
-130	840
-163	845
-180	850

 <p>BYER GEOTECHNICAL INC.</p>	<i>Project</i> BG 21898 HARVARD-WESTLAKE SECTION 5			
	<i>Analysis Description</i> CALCULATE THE MINIMUM REQUIRED EFP APPLIED TO SOIL NAIL WALLS TO ACHIEVE FS=1.0 (SEISMIC)			
	<i>Drawn By</i> R. ZWEIGLER	<i>Scale</i>	<i>Company</i> BYER GEOTECHNICAL, INC.	
	<i>Date</i> 5/18/15		<i>File Name</i> 21898 Section 5 efp EQ.slim	
<small>SLIDEINTERPRET 6.035</small>				

-230	865
-400	865
-400	675
217	675
217	720
110	720



BYER
GEOTECHNICAL
INC.

SLIDEINTERPRET 6.035

<i>Project</i>			
BG 21898 HARVARD-WESTLAKE SECTION 5			
<i>Analysis Description</i>			
CALCULATE THE MINIMUM REQUIRED EFP APPLIED TO SOIL NAIL WALLS TO ACHIEVE FS=1.0 (SEISMIC)			
<i>Drawn By</i>	R. ZWEIGLER	<i>Scale</i>	<i>Company</i>
			BYER GEOTECHNICAL, INC.
<i>Date</i>	5/18/15	<i>File Name</i>	21898 Section 5 efp EQ.slim

BG 21898 HARVARD WESTLAKE SECTION 5

CALCULATE THE MINIMUM REQUIRED EFP TO GENERATE A FACTOR OF SAFETY OF 1.5 APPLIED SO AS TO REPRESENT THE MASS OF EARTH CONSISTING OF A SOIL NAIL WALL.

THE RESULTS INDICATE THAT AN EFP OF 67 PCF WILL ACHIEVE A FACTOR OF SAFETY OF GREATER THAN 1.5.

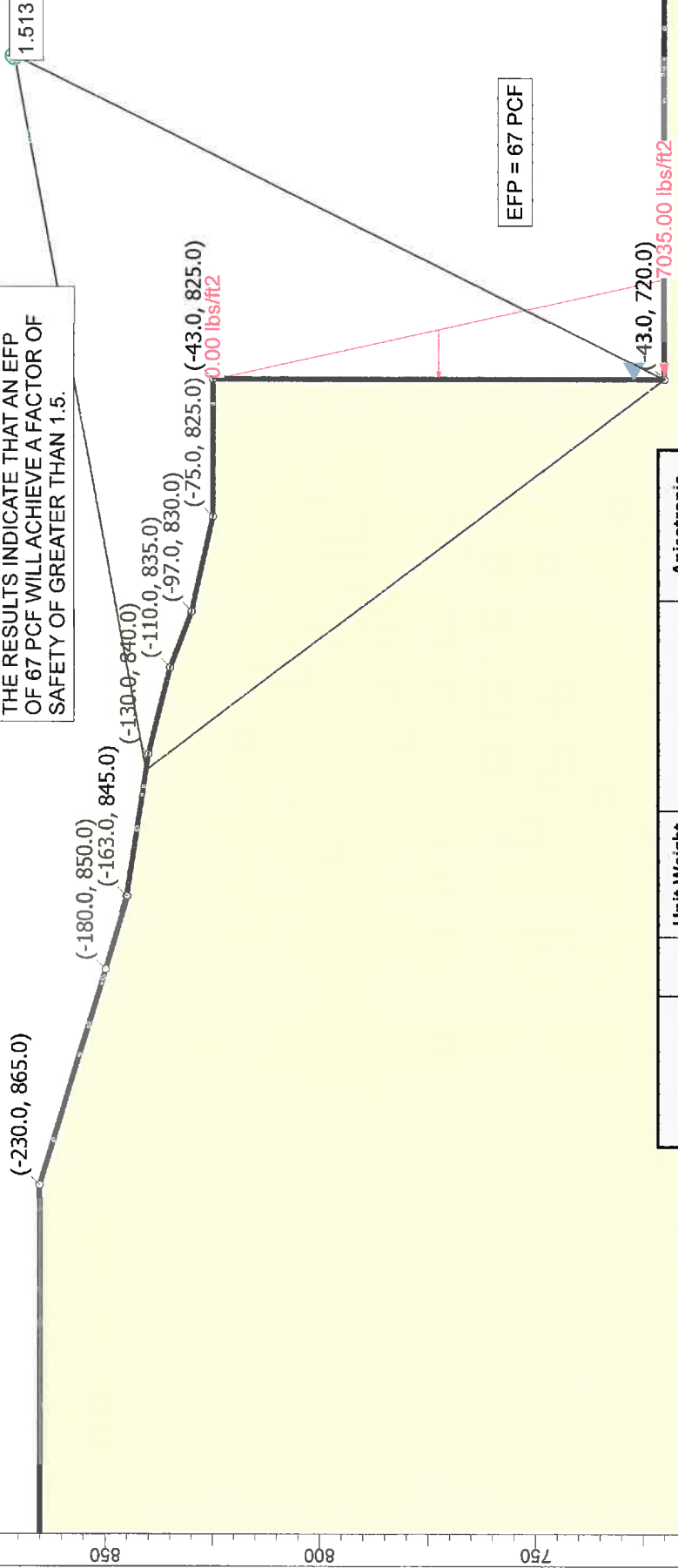

Material Name	Color	Unit Weight (lbs/ft3)	Strength Type	Anisotropic Function
Bedrock		115	Anisotropic function	User Defined 1

BYER GEOTECHNICAL INC.

Project: BG 21898 HARVARD-WESTLAKE SECTION 5
 Analysis Description: CALCULATE THE MINIMUM REQUIRED EFP TO REPRESENT THE SOIL NAIL EARTH BLOCK
 Drawn By: R. ZWEIGLER
 Date: 5/18/15
 Scale: 1:468
 Company: BYER GEOTECHNICAL, INC.
 File Name: 21898 Section 5 efp on back of soil nail wall.slm

Slide Analysis Information

BG 21898 HARVARD-WESTLAKE SECTION 5

Project Summary

File Name: 21898 Section 5 efp on back of soil nail wall
Slide Modeler Version: 6.035
Project Title: BG 21898 HARVARD-WESTLAKE SECTION 5
Analysis: CALCULATE THE MINIMUM REQUIRED EFP TO REPRESENT THE SOIL NAIL EARTH BLOCK
Author: R. ZWEIGLER
Company: BYER GEOTECHNICAL, INC.
Date Created: 5/18/15

General Settings

Units of Measurement: Imperial Units
Time Units: days
Permeability Units: feet/second
Failure Direction: Left to Right
Data Output: Standard
Maximum Material Properties: 20
Maximum Support Properties: 20

Analysis Options

Analysis Methods Used

Spencer

Number of slices: 25
Tolerance: 0.005
Maximum number of iterations: 50
Check $\alpha < 0.2$: Yes
Initial trial value of FS: 1
Steffensen Iteration: Yes

Groundwater Analysis

Groundwater Method: Water Surfaces
Pore Fluid Unit Weight: 62.4 lbs/ft³
Advanced Groundwater Method: None

Random Numbers

 BYER GEOTECHNICAL INC.	<i>Project</i> BG 21898 HARVARD-WESTLAKE SECTION 5		
	<i>Analysis Description</i> CALCULATE THE MINIMUM REQUIRED EFP TO REPRESENT THE SOIL NAIL EARTH BLOCK		
	<i>Drawn By</i> R. ZWEIGLER	<i>Scale</i>	<i>Company</i> BYER GEOTECHNICAL, INC.
	<i>Date</i> 5/18/15	<i>File Name</i> 21898 Section 5 efp on back of soil nail wall.slim	
SLIDEINTERPRET 6.035			

Surface Options

Loading

1 Distributed Load present

Distributed Load 1

Distribution: Triangular
 Magnitude 1 [psf]: 0
 Magnitude 2 [psf]: 7035
 Orientation: Horizontal

Material Properties

Property	Bedrock
Color	<input type="checkbox"/>
Strength Type	Anisotropic function
Unit Weight [lbs/ft3]	115
Water Surface	None
Ru Value	0

Anisotropic Functions

Name: User Defined 1

Angle From	Angle To	c	phi
-90	-65	540	36
-65	-53	510	19.5
-53	-27	540	36
-27	-15	510	19.5
-15	90	540	36

Global Minimums

Method: spencer

FS: 1.513150
 Axis Location: 32.147, 871.117
 Left Slip Surface Endpoint: -133.816, 840.578
 Right Slip Surface Endpoint: -43.000, 720.023
 Left Slope Intercept: -133.816 840.578

 BYER GEOTECHNICAL INC.	Project BG 21898 HARVARD-WESTLAKE SECTION 5		
	Analysis Description CALCULATE THE MINIMUM REQUIRED EFP TO REPRESENT THE SOIL NAIL EARTH BLOCK		
	Drawn By R. ZWEIGLER	Scale	Company BYER GEOTECHNICAL, INC.
	Date 5/18/15		File Name 21898 Section 5 efp on back of soil nail wall.slim

Right Slope Intercept: -43.000 825.000
 Resisting Moment=4.40995e+007 lb-ft
 Driving Moment=2.91441e+007 lb-ft
 Resisting Horizontal Force=175802 lb
 Driving Horizontal Force=116182 lb
 Total Slice Area=4520.66 ft²

Global Minimum Coordinates

Method: spencer

X	Y
-133.816	840.578
-119.546	821.632
-106.918	804.866
-97.8836	792.871
-85.4903	776.42
-61.1254	744.081
-58.0085	739.944
-43	720.023
-42.999	825

Valid / Invalid Surfaces

Method: spencer

Number of Valid Surfaces: 1
 Number of Invalid Surfaces: 0

Slice Data

Global Minimum Query (spencer) - Safety Factor: 1.51315

Slice Number	Width [ft]	Weight [lbs]	Base Material	Base Cohesion [psf]	Base Friction Angle [degrees]	Shear Stress [psf]	Shear Strength [psf]	Base Normal Stress [psf]	Pore Pressure [psf]	Effective Normal Stress [psf]
1	3.56752	860.751	Bedrock	510	19.5	301.861	456.761	-150.343	0	-150.343
2	3.56752	2519.87	Bedrock	510	19.5	383.65	580.52	199.143	0	199.143
3	3.56752	4097.57	Bedrock	510	19.5	461.426	698.207	531.479	0	531.479
4	3.56752	5674.93	Bedrock	510	19.5	539.184	815.867	863.743	0	863.743
5	3.157	6337.43	Bedrock	510	19.5	612.469	926.758	1176.89	0	1176.89
6	3.157	7572.65	Bedrock	510	19.5	681.28	1030.88	1470.92	0	1470.92
7	3.157	8807.88	Bedrock	510	19.5	750.091	1135	1764.95	0	1764.95
8	3.157	9969.56	Bedrock	510	19.5	814.806	1232.92	2041.47	0	2041.47
9	4.51708	16144.4	Bedrock	510	19.5	887.995	1343.67	2354.21	0	2354.21
10	4.51708	18357.3	Bedrock	510	19.5	974.152	1474.04	2722.35	0	2722.35

 BYER GEOTECHNICAL INC.	Project			BG 21898 HARVARD-WESTLAKE SECTION 5						
	Analysis Description						CALCULATE THE MINIMUM REQUIRED EFP TO REPRESENT THE SOIL NAIL EARTH BLOCK			
	Drawn By		R. ZWEIGLER		Scale		Company		BYER GEOTECHNICAL, INC.	
	Date		5/18/15		File Name		21898 Section 5 efp on back of soil nail wall.slim			

11	4.13109	18821.1	Bedrock	510	19.5	1060.74	1605.06	3092.34	0	3092.34
12	4.13109	20973.1	Bedrock	510	19.5	1152.36	1743.69	3483.83	0	3483.83
13	4.13109	23132.2	Bedrock	510	19.5	1244.28	1882.78	3876.61	0	3876.61
14	3.4807	21166.2	Bedrock	510	19.5	1328.98	2010.95	4238.55	0	4238.55
15	3.4807	22698.8	Bedrock	510	19.5	1406.42	2128.13	4569.48	0	4569.48
16	3.4807	24231.4	Bedrock	510	19.5	1483.87	2245.32	4900.39	0	4900.39
17	3.4807	25918	Bedrock	510	19.5	1569.09	2374.27	5264.54	0	5264.54
18	3.4807	27767.2	Bedrock	510	19.5	1662.54	2515.67	5663.82	0	5663.82
19	3.4807	29616.5	Bedrock	510	19.5	1755.98	2657.06	6063.11	0	6063.11
20	3.4807	31465.7	Bedrock	510	19.5	1849.43	2798.46	6462.39	0	6462.39
21	3.11697	29747.1	Bedrock	510	19.5	1937.98	2932.46	6840.82	0	6840.82
22	3.75212	37775.7	Bedrock	510	19.5	2030.19	3071.98	7234.82	0	7234.82
23	3.75212	39924.6	Bedrock	510	19.5	2130.92	3224.4	7665.23	0	7665.23
24	3.75212	42073.5	Bedrock	510	19.5	2231.65	3376.82	8095.66	0	8095.66
25	3.75212	44222.4	Bedrock	510	19.5	2648.58	4007.7	9877.21	0	9877.21

Interslice Data

Global Minimum Query (spencer) - Safety Factor: 1.51315

Slice Number	X coordinate [ft]	Y coordinate - Bottom [ft]	Interslice Normal Force [lbs]	Interslice Shear Force [lbs]	Interslice Force Angle [degrees]
1	-133.816	840.578	0	0	0
2	-130.248	835.842	-1789.01	-32.689	1.0468
3	-126.681	831.105	-2214.42	-40.4623	1.0468
4	-123.113	826.368	-1343.16	-24.5424	1.0468
5	-119.546	821.632	824.497	15.0653	1.0468
6	-116.389	817.44	3823.92	69.8713	1.0468
7	-113.232	813.249	7838.55	143.227	1.0468
8	-110.075	809.057	12868.4	235.133	1.0468
9	-106.918	804.866	18853	344.484	1.0468
10	-102.401	798.868	28960.8	529.176	1.0468
11	-97.8836	792.871	40887.4	747.101	1.0468
12	-93.7525	787.387	53462.4	976.874	1.0468
13	-89.6214	781.904	67805.8	1238.96	1.0468
14	-85.4903	776.42	83923.1	1533.46	1.0468
15	-82.0096	771.8	98879.1	1806.73	1.0468
16	-78.5289	767.18	115094	2103.02	1.0468
17	-75.0482	762.56	132569	2422.32	1.0468
18	-71.5675	757.941	151429	2766.93	1.0468
19	-68.0868	753.321	171809	3139.31	1.0468
20	-64.6061	748.701	193708	3539.45	1.0468
21	-61.1254	744.081	217126	3967.36	1.0468
22	-58.0085	739.944	239387	4374.11	1.0468

 <p>BYER GEOTECHNICAL INC.</p>	Project			BG 21898 HARVARD-WESTLAKE SECTION 5																			
	Analysis Description						CALCULATE THE MINIMUM REQUIRED EFP TO REPRESENT THE SOIL NAIL EARTH BLOCK																
	Drawn By			R. ZWEIGLER			Scale			Company			BYER GEOTECHNICAL, INC.										
	Date						5/18/15						File Name						21898 Section 5 efp on back of soil nail wall.slim				

23	-54.2563	734.964	267800	4893.28	1.0468
24	-50.5042	729.983	297979	5444.71	1.0468
25	-46.7521	725.003	329923	6028.4	1.0468
26	-43	720.023	369175	0	0

List Of Coordinates

Distributed Load

X	Y
-43	825
-43	720

External Boundary

X	Y
-43	720
-43	825
-75	825
-97	830
-110	835
-130	840
-163	845
-180	850
-230	865
-400	865
-400	675
217	675
217	720
110	720

 <p>BYER GEOTECHNICAL INC.</p>	<i>Project</i>		
	BG 21898 HARVARD-WESTLAKE SECTION 5		
	<i>Analysis Description</i>		
	CALCULATE THE MINIMUM REQUIRED EFP TO REPRESENT THE SOIL NAIL EARTH BLOCK		
<i>Drawn By</i>	R. ZWEIGLER	<i>Scale</i>	<i>Company</i>
			BYER GEOTECHNICAL, INC.
<i>Date</i>	5/18/15		<i>File Name</i>
			21898 Section 5 efp on back of soil nail wall.slim

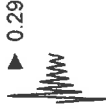

BG 21898 HARVARD WESTLAKE SECTION 5

CALCULATE THE MINIMUM REQUIRED EFP APPLIED TO THE FACE OF THE PROPOSED SOIL NAIL CONFIGURATION TO ACHIEVE A FACTOR OF SAFETY OF 1.0 UNDER SEISMIC LOADING. NOTE: THE SEARCH WAS LIMITED TO THE UPSLOPE DISTANCE RESULTING IN THE MOST CRITICAL FAILURE UNDER STATIC CONDITIONS.

THE RESULTS INDICATE THAT AN EFP OF 75 PCF WILL ACHIEVE A FACTOR OF SAFETY IN EXCESS OF 1.0.

1.018

EFP = 75 PCF

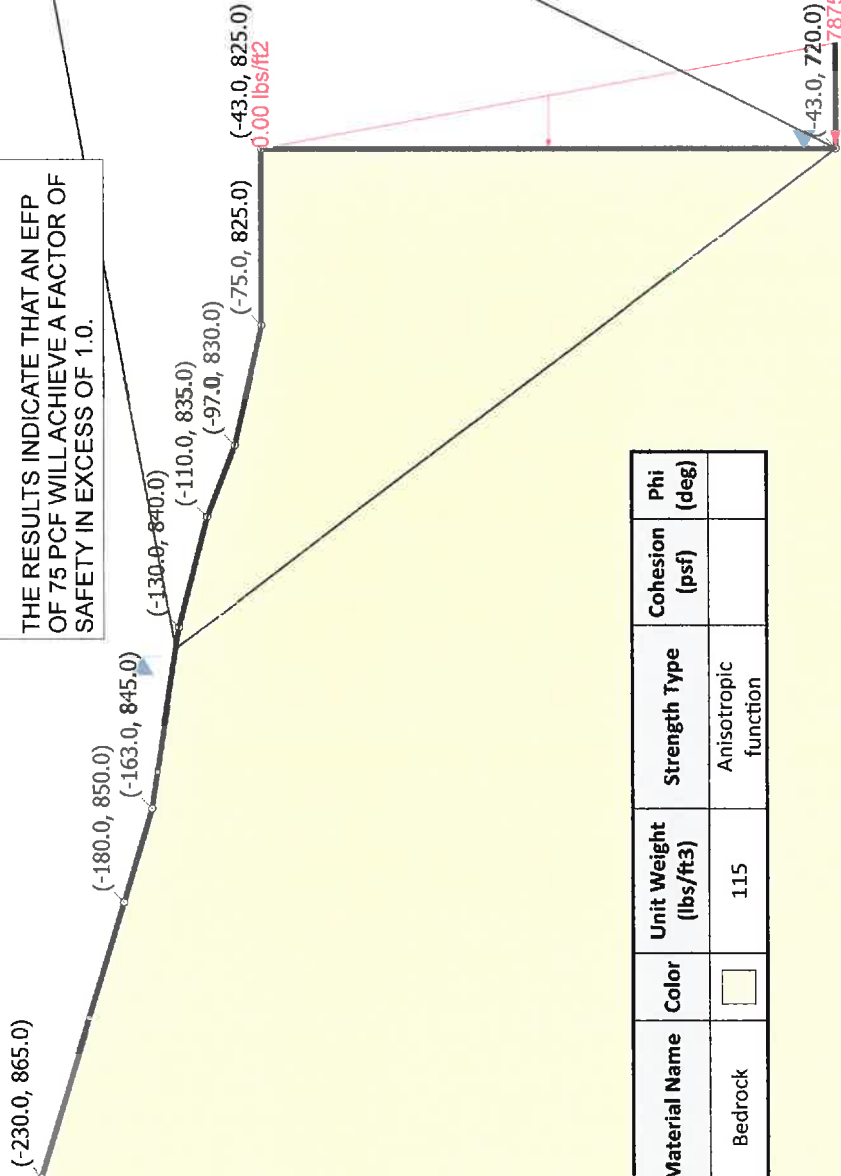

Material Name	Color	Unit Weight (lbs/ft3)	Strength Type	Cohesion (psf)	Phi (deg)
Bedrock	<input type="checkbox"/>	115	Anisotropic function		

BG 21898 HARVARD-WESTLAKE SECTION 5

ANALYSIS DESCRIPTION: CALCULATE THE MINIMUM REQUIRED EFP TO REPRESENT THE SOIL NAIL EARTH BLOCK (SEISMIC)
 DRAWN BY: R. ZWIEGLER
 SCALE: 1:421
 COMPANY: BYER GEOTECHNICAL, INC.

DATE: 5/18/15
 FILE NAME: 21898 Section 5 efp on back of soil nail wall EQ.slim



Slide Analysis Information

BG 21898 HARVARD-WESTLAKE SECTION 5

Project Summary

File Name: 21898 Section 5 efp on back of soil nail wall EQ
Slide Modeler Version: 6.035
Project Title: BG 21898 HARVARD-WESTLAKE SECTION 5
Analysis: CALCULATE THE MINIMUM REQUIRED EFP TO REPRESENT THE SOIL NAIL EARTH BLOCK (SEISMIC)
Author: R. ZWEIGLER
Company: BYER GEOTECHNICAL, INC.
Date Created: 5/18/15

General Settings

Units of Measurement: Imperial Units
Time Units: days
Permeability Units: feet/second
Failure Direction: Left to Right
Data Output: Standard
Maximum Material Properties: 20
Maximum Support Properties: 20

Analysis Options

Analysis Methods Used

Spencer

Number of slices: 25
Tolerance: 0.005
Maximum number of iterations: 50
Check $\alpha < 0.2$: Yes
Initial trial value of FS: 1
Steffensen Iteration: Yes

Groundwater Analysis

Groundwater Method: Water Surfaces
Pore Fluid Unit Weight: 62.4 lbs/ft³
Advanced Groundwater Method: None

Random Numbers

 BYER GEOTECHNICAL INC. SLIDEINTERPRET 6.035	<i>Project</i> BG 21898 HARVARD-WESTLAKE SECTION 5		
	<i>Analysis Description</i> CALCULATE THE MINIMUM REQUIRED EFP TO REPRESENT THE SOIL NAIL EARTH BLOCK		
	<i>Drawn By</i> R. ZWEIGLER	<i>Scale</i>	<i>Company</i> BYER GEOTECHNICAL, INC.
	<i>Date</i> 5/18/15	<i>File Name</i> 21898 Section 5 efp on back of soil nail wall EQ slim	

Surface Options

Loading

Seismic Load Coefficient (Horizontal): 0.29
 1 Distributed Load present

Distributed Load 1

Distribution: Triangular
 Magnitude 1 [psf]: 0
 Magnitude 2 [psf]: 7875
 Orientation: Horizontal

Material Properties

Property	Bedrock
Color	<input type="checkbox"/>
Strength Type	Anisotropic function
Unit Weight [lbs/ft3]	115
Water Surface	None
Ru Value	0

Anisotropic Functions

Name: User Defined 1

Angle From	Angle To	c	phi
-90	-65	827	37
-65	-53	510	19.5
-53	-27	827	37
-27	-15	510	19.5
-15	90	827	37

Global Minimums

Method: spencer

FS: 1.018210
 Axis Location: 32.159, 871.134
 Left Slip Surface Endpoint: -133.841, 840.582
 Right Slip Surface Endpoint: -43.000, 720.003

 BYER GEOTECHNICAL INC.	<i>Project</i> BG 21898 HARVARD-WESTLAKE SECTION 5		
	<i>Analysis Description</i> CALCULATE THE MINIMUM REQUIRED EFP TO REPRESENT THE SOIL NAIL EARTH BLOCK		
	<i>Drawn By</i> R. ZWEIGLER	<i>Scale</i>	<i>Company</i> BYER GEOTECHNICAL, INC.
	<i>Date</i> 5/18/15	<i>File Name</i> 21898 Section 5 erp on back of soil nail wall EQ slim	

Left Slope Intercept: -133.841 840.582
 Right Slope Intercept: -43.000 825.000
 Resisting Moment=3.9568e+007 lb-ft
 Driving Moment=3.88604e+007 lb-ft
 Resisting Horizontal Force=157709 lb
 Driving Horizontal Force=154889 lb
 Total Slice Area=4522.73 ft2

Global Minimum Coordinates

Method: spencer

X	Y
-133.841	840.582
-123.775	827.22
-112.197	811.85
-99.134	794.509
-73.7434	760.807
-70.2052	756.111
-52.7919	732.999
-43	720.003
-42.999	825

Valid / Invalid Surfaces

Method: spencer

Number of Valid Surfaces: 1
 Number of Invalid Surfaces: 0

Slice Data

Global Minimum Query (spencer) - Safety Factor: 1.01821

Slice Number	Width [ft]	Weight [lbs]	Base Material	Base Cohesion [psf]	Base Friction Angle [degrees]	Shear Stress [psf]	Shear Strength [psf]	Base Normal Stress [psf]	Pore Pressure [psf]	Effective Normal Stress [psf]
1	3.35533	761.248	Bedrock	510	19.5	442.928	450.994	-166.628	0	-166.628
2	3.35533	2237.12	Bedrock	510	19.5	520.766	530.249	57.1819	0	57.1819
3	3.35533	3633.45	Bedrock	510	19.5	594.408	605.233	268.928	0	268.928
4	3.85933	5904.26	Bedrock	510	19.5	673.505	685.77	496.361	0	496.361
5	3.85933	7749.8	Bedrock	510	19.5	758.128	771.934	739.681	0	739.681
6	3.85933	9595.34	Bedrock	510	19.5	842.751	858.098	982.999	0	982.999
7	3.26585	9552.61	Bedrock	510	19.5	920.39	937.15	1206.23	0	1206.23
8	3.26585	10746.4	Bedrock	510	19.5	985.078	1003.02	1392.23	0	1392.23
9	3.26585	11902.9	Bedrock	510	19.5	1047.74	1066.82	1572.41	0	1572.41

 BYER GEOTECHNICAL INC.	Project			BG 21898 HARVARD-WESTLAKE SECTION 5																			
	Analysis Description						CALCULATE THE MINIMUM REQUIRED EFP TO REPRESENT THE SOIL NAIL EARTH BLOCK																
	Drawn By			R. ZWEIGLER			Scale			Company			BYER GEOTECHNICAL, INC.										
	Date						5/18/15						File Name						BG 21898 Section 5 efp on back of soil nail wall EQ slim				

10	3.26585	13059.4	Bedrock	510	19.5	1110.4	1130.63	1752.59	0	1752.59
11	3.62723	15880	Bedrock	510	19.5	1177.56	1199	1945.68	0	1945.68
12	3.62723	17503.2	Bedrock	510	19.5	1256.75	1279.64	2173.4	0	2173.4
13	3.62723	19167.7	Bedrock	510	19.5	1337.96	1362.33	2406.89	0	2406.89
14	3.62723	20832.1	Bedrock	510	19.5	1419.17	1445.01	2640.39	0	2640.39
15	3.62723	22496.5	Bedrock	510	19.5	1500.37	1527.69	2873.88	0	2873.88
16	3.62723	24160.9	Bedrock	510	19.5	1581.58	1610.38	3107.37	0	3107.37
17	3.62723	25846	Bedrock	510	19.5	1663.79	1694.09	3343.75	0	3343.75
18	3.53819	27074.8	Bedrock	510	19.5	1757.02	1789.02	3611.84	0	3611.84
19	4.35333	35934.3	Bedrock	510	19.5	1863.6	1897.54	3918.31	0	3918.31
20	4.35333	38827	Bedrock	510	19.5	1981.2	2017.28	4256.42	0	4256.42
21	4.35333	41719.7	Bedrock	510	19.5	2098.8	2137.02	4594.56	0	4594.56
22	4.35333	44612.4	Bedrock	510	19.5	2216.39	2256.75	4932.67	0	4932.67
23	3.26397	35346.2	Bedrock	510	19.5	2319.28	2361.51	5228.49	0	5228.49
24	3.26397	36972.3	Bedrock	510	19.5	2407.44	2451.28	5482.01	0	5482.01
25	3.26397	38598.4	Bedrock	510	19.5	10539.2	10731.1	28863.6	0	28863.6

Interslice Data

Global Minimum Query (spencer) - Safety Factor: 1.01821

Slice Number	X coordinate [ft]	Y coordinate - Bottom [ft]	Interslice Normal Force [lbs]	Interslice Shear Force [lbs]	Interslice Force Angle [degrees]
1	-133.841	840.582	0	0	0
2	-130.486	836.128	-2007.58	-652.499	18.0051
3	-127.131	831.674	-2851.47	-926.775	18.005
4	-123.775	827.22	-2594.37	-843.216	18.0051
5	-119.916	822.097	-938.509	-305.031	18.005
6	-116.057	816.974	2172.53	706.11	18.0051
7	-112.197	811.85	6738.75	2190.21	18.0051
8	-108.932	807.515	11732.5	3813.27	18.0051
9	-105.666	803.18	17667.6	5742.28	18.0051
10	-102.4	798.845	24514.6	7967.66	18.005
11	-99.134	794.509	32273.4	10489.4	18.005
12	-95.5068	789.695	41974.9	13642.6	18.0051
13	-91.8796	784.88	52956.2	17211.7	18.0051
14	-88.2523	780.066	65249.8	21207.3	18.005
15	-84.6251	775.251	78855.7	25629.5	18.0051
16	-80.9979	770.437	93773.9	30478.1	18.005
17	-77.3707	765.622	110004	35753.3	18.0051
18	-73.7434	760.807	127564	41460.3	18.005
19	-70.2052	756.111	146160	47504.6	18.0051
20	-65.8519	750.333	171108	55613.2	18.0051
21	-61.4986	744.555	198337	64463	18.0051

 BYER GEOTECHNICAL INC.	Project			BG 21898 HARVARD-WESTLAKE SECTION 5		
	Analysis Description					CALCULATE THE MINIMUM REQUIRED EFP TO REPRESENT THE SOIL NAIL EARTH BLOCK
	Drawn By		R. ZWEIGLER	Scale		Company
	Date		5/18/15	File Name		BYER GEOTECHNICAL, INC. BG 21898 Section 5 erp on back of soil nail wall EQ slim

22	-57.1452	738.777	227847	74054.1	18.005
23	-52.7919	732.999	259637	84386.4	18.005
24	-49.5279	728.667	284968	92619.4	18.005
25	-46.264	724.335	311581	101269	18.005
26	-43	720.003	413417	0	0

List Of Coordinates

Distributed Load

X	Y
-43	825
-43	720

External Boundary

X	Y
-43	720
-43	825
-75	825
-97	830
-110	835
-130	840
-163	845
-180	850
-230	865
-400	865
-400	675
217	675
217	720
110	720

 <p>BYER GEOTECHNICAL INC.</p>	<i>Project</i>			
	BG 21898 HARVARD-WESTLAKE SECTION 5			
	<i>Analysis Description</i>			
	CALCULATE THE MINIMUM REQUIRED EFP TO REPRESENT THE SOIL NAIL EARTH BLOCK			
<i>Drawn By</i>		<i>Scale</i>	<i>Company</i>	
R. ZWEIGLER			BYER GEOTECHNICAL, INC.	
<i>Date</i>		<i>File Name</i>		
5/18/15		BG 21898 Section 5 erp on back of soil nail wall		EQ slim

BG 21898 HARVARD-WESTLAKE SECTION 6

DETERMINE THE LOCATION OF THE 1.5 FACTOR OF SAFETY PLANE BEFORE ADDING ANY SUPPORT FORCES FROM THE PROPOSED RETAINING WALL.

THE MINIMUM FS IS > 1.5.

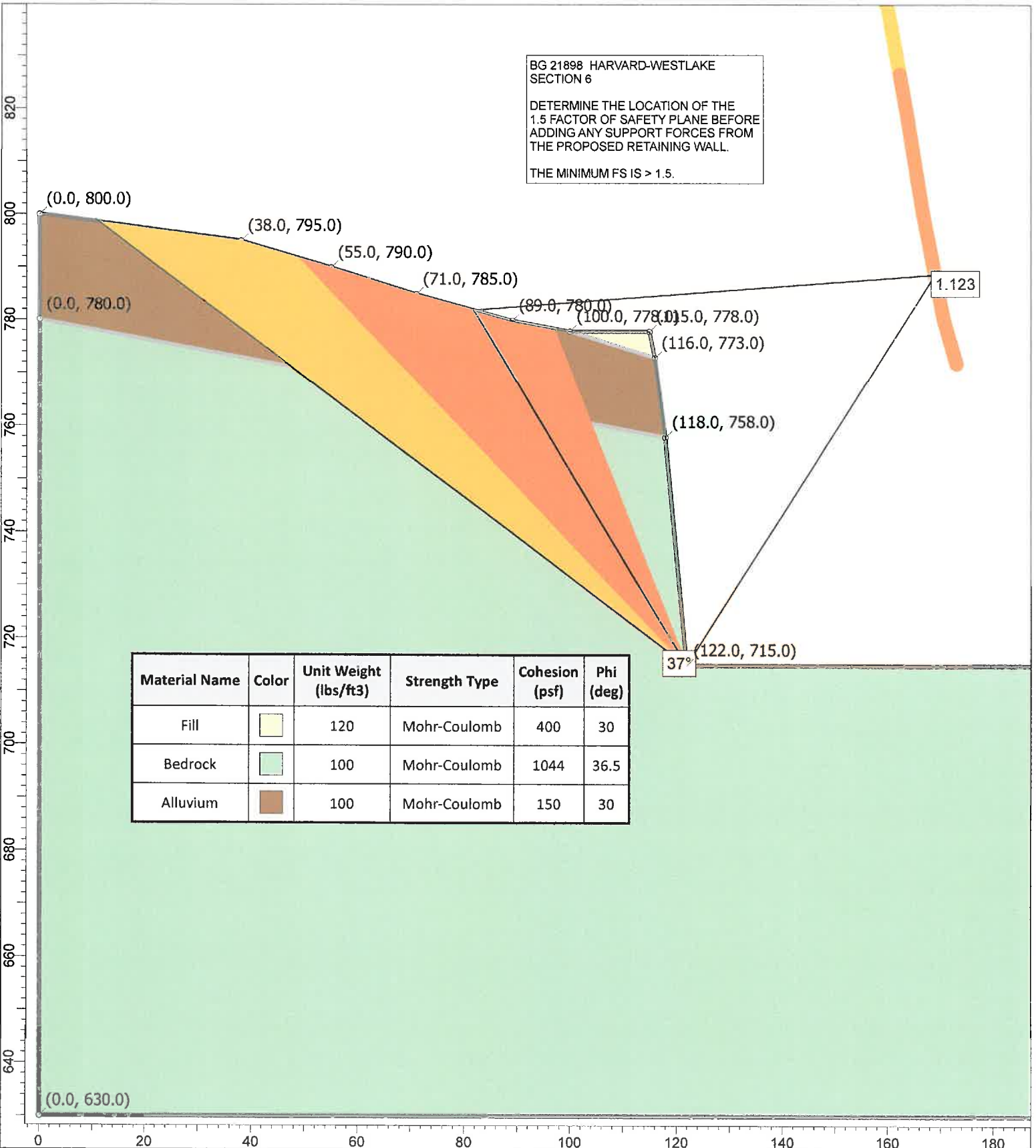

Material Name	Color	Unit Weight (lbs/ft ³)	Strength Type	Cohesion (psf)	Phi (deg)
Fill		120	Mohr-Coulomb	400	30
Bedrock		100	Mohr-Coulomb	1044	36.5
Alluvium		100	Mohr-Coulomb	150	30

	Project				
	BG 21898 HARVARD WESTLAKE SECTION 6				
	Analysis Description				
	CALCULATE THE LOCATION OF THE 1.5 FACTOR OF SAFETY PLANE				
Drawn By	R. ZWEIGLER	Scale	1:291	Company	BYER GEOTECHNICAL, INC.
Date	3/11/15	File Name	21898 Section 6.slim		

Slide Analysis Information

BG 21898 HARVARD WESTLAKE SECTION 6

Project Summary

File Name: 21898 Section 6
Slide Modeler Version: 6.033
Project Title: BG 21898 HARVARD WESTLAKE SECTION 6
Analysis: CALCULATE THE LOCATION OF THE 1.5 FACTOR OF SAFETY PLANE
Author: R. ZWEIGLER
Company: BYER GEOTECHNICAL, INC.
Date Created: 3/11/15

General Settings

Units of Measurement: Imperial Units
Time Units: days
Permeability Units: feet/second
Failure Direction: Left to Right
Data Output: Standard
Maximum Material Properties: 20
Maximum Support Properties: 20

Analysis Options

Analysis Methods Used

Janbu corrected

Number of slices: 25
Tolerance: 0.005
Maximum number of iterations: 50
Check malpha < 0.2: Yes
Initial trial value of FS: 1
Steffensen Iteration: Yes

Groundwater Analysis

Groundwater Method: Water Surfaces
Pore Fluid Unit Weight: 62.4 lbs/ft³
Advanced Groundwater Method: None

 BYER GEOTECHNICAL INC.	<i>Project</i> BG 21898 HARVARD WESTLAKE SECTION 6		
	<i>Analysis Description</i> CALCULATE THE LOCATION OF THE 1.5 FACTOR OF SAFETY PLANE		
	<i>Drawn By</i> R. ZWEIGLER	<i>Scale</i>	<i>Company</i> BYER GEOTECHNICAL, INC.
	<i>Date</i> 3/11/15	<i>File Name</i> 21898 Section 6.slim	

Random Numbers

Pseudo-random Seed: 10116

Random Number Generation Method: Park and Miller v.3

Surface Options

Surface Type: Non-Circular Block Search

Number of Surfaces: 5000

Pseudo-Random Surfaces: Enabled

Convex Surfaces Only: Disabled

Left Projection Angle (Start Angle): 95

Left Projection Angle (End Angle): 265



Right Projection Angle (Start Angle): -85

Right Projection Angle (End Angle): 85

Minimum Elevation: Not Defined

Minimum Depth: Not Defined

Material Properties

Property	Fill	Bedrock	Alluvium
Color			
Strength Type	Mohr-Coulomb	Mohr-Coulomb	Mohr-Coulomb
Unit Weight [lbs/ft3]	120	100	100
Cohesion [psf]	400	1044	150
Friction Angle [deg]	30	36.5	30
Water Surface	None	None	None
Ru Value	0	0	0

Global Minimums

Method: janbu corrected

FS: 1.123200

Axis Location: 168.880, 788.802

Left Slip Surface Endpoint: 81.711, 782.025

Right Slip Surface Endpoint: 122.000, 715.000

Resisting Horizontal Force=51336 lb

Driving Horizontal Force=45705 lb

Total Slice Area=1027.49 ft2

Global Minimum Coordinates

 BYER GEOTECHNICAL INC.	<i>Project</i> BG 21898 HARVARD WESTLAKE SECTION 6		
	<i>Analysis Description</i> CALCULATE THE LOCATION OF THE 1.5 FACTOR OF SAFETY PLANE		
	<i>Drawn By</i> R. ZWEIGLER	<i>Scale</i>	<i>Company</i> BYER GEOTECHNICAL, INC.
	<i>Date</i> 3/11/15	<i>File Name</i> 21898 Section 6.slim	

Method: janbu corrected

X	Y
81.7109	782.025
122	715

Valid / Invalid Surfaces

Method: janbu corrected

Number of Valid Surfaces: 3371
 Number of Invalid Surfaces: 1629

Error Codes:

Error Code -108 reported for 1629 surfaces

Error Codes

The following errors were encountered during the computation:

-108 = Total driving moment or total driving force < 0.1. This is to limit the calculation of extremely high safety factors if the driving force is very small (0.1 is an arbitrary number).

Slice Data

Global Minimum Query (janbu corrected) - Safety Factor: 1.1232

Slice Number	Width [ft]	Weight [lbs]	Base Material	Base Cohesion [psf]	Base Friction Angle [degrees]	Shear Stress [psf]	Shear Strength [psf]	Base Normal Stress [psf]	Pore Pressure [psf]	Effective Normal Stress [psf]
1	1.66914	193.045	Alluvium	150	30	104.04	116.858	-57.4032	0	-57.4032
2	1.66914	579.136	Alluvium	150	30	168.137	188.851	67.292	0	67.292
3	1.66914	965.226	Alluvium	150	30	232.233	260.844	191.987	0	191.987
4	1.66914	1351.32	Alluvium	150	30	296.329	332.837	316.681	0	316.681
5	1.66914	1742.76	Alluvium	150	30	361.314	405.828	443.108	0	443.108
6	1.66914	2153.79	Alluvium	150	30	429.55	482.47	575.856	0	575.856
7	1.66914	2566.61	Alluvium	150	30	498.084	559.448	709.184	0	709.184
8	1.58918	2827.29	Bedrock	1044	36.5	1002.73	1126.26	111.174	0	111.174
9	1.58918	3201.51	Bedrock	1044	36.5	1076.75	1209.4	223.53	0	223.53
10	1.58918	3575.73	Bedrock	1044	36.5	1150.77	1292.54	335.886	0	335.886
11	1.58918	3949.95	Bedrock	1044	36.5	1224.79	1375.68	448.243	0	448.243
12	1.58918	4346.13	Bedrock	1044	36.5	1303.15	1463.7	567.192	0	567.192
13	1.58918	4781.3	Bedrock	1044	36.5	1389.23	1560.38	697.846	0	697.846

 BYER GEOTECHNICAL INC.	Project		BG 21898 HARVARD WESTLAKE SECTION 6		
	Analysis Description				CALCULATE THE LOCATION OF THE 1.5 FACTOR OF SAFETY PLANE
	Drawn By	R. ZWEIGLER	Scale	Company	
	Date	3/11/15	File Name		21898 Section 6.slim

14	1.58918	5217.22	Bedrock	1044	36.5	1475.45	1657.23	828.731	0	828.731
15	1.58918	5653.14	Bedrock	1044	36.5	1561.68	1754.08	959.613	0	959.613
16	1.58918	6089.07	Bedrock	1044	36.5	1647.9	1850.92	1090.49	0	1090.49
17	1.58918	6524.99	Bedrock	1044	36.5	1734.13	1947.77	1221.38	0	1221.38
18	1.58918	6960.91	Bedrock	1044	36.5	1820.35	2044.62	1352.26	0	1352.26
19	1.58918	7396.83	Bedrock	1044	36.5	1906.58	2141.47	1483.14	0	1483.14
20	1.58918	7832.75	Bedrock	1044	36.5	1992.8	2238.31	1614.02	0	1614.02
21	1.58918	8144.53	Bedrock	1044	36.5	2054.47	2307.58	1707.63	0	1707.63
22	1.58918	7214.9	Bedrock	1044	36.5	1870.59	2101.05	1428.52	0	1428.52
23	1.58918	5641.16	Bedrock	1044	36.5	1559.31	1751.41	956.015	0	956.015
24	1.58918	3442.13	Bedrock	1044	36.5	1124.34	1262.86	295.774	0	295.774
25	1.58918	1147.38	Bedrock	1044	36.5	670.443	753.042	-393.209	0	-393.209

Interslice Data

Global Minimum Query (janbu corrected) - Safety Factor: 1.1232

Slice Number	X coordinate [ft]	Y coordinate - Bottom [ft]	Interslice Normal Force [lbs]	Interslice Shear Force [lbs]	Interslice Force Angle [degrees]
1	81.7109	782.025	0	0	0
2	83.38	779.248	-333.031	0	0
3	85.0491	776.471	-426.784	0	0
4	86.7183	773.694	-281.26	0	0
5	88.3874	770.918	103.541	0	0
6	90.0565	768.141	730.94	0	0
7	91.7257	765.364	1613.07	0	0
8	93.3948	762.587	2751.04	0	0
9	94.984	759.944	1451.65	0	0
10	96.5732	757.3	331.677	0	0
11	98.1623	754.656	-608.867	0	0
12	99.7515	752.012	-1369.99	0	0
13	101.341	749.369	-1941.15	0	0
14	102.93	746.725	-2303.67	0	0
15	104.519	744.081	-2457.17	0	0
16	106.108	741.437	-2401.67	0	0
17	107.697	738.794	-2137.16	0	0
18	109.287	736.15	-1663.63	0	0
19	110.876	733.506	-981.101	0	0
20	112.465	730.862	-89.5586	0	0
21	114.054	728.219	1010.99	0	0
22	115.643	725.575	2261.03	0	0
23	117.232	722.931	3065.34	0	0

	Project		BG 21898 HARVARD WESTLAKE SECTION 6	
	Analysis Description		CALCULATE THE LOCATION OF THE 1.5 FACTOR OF SAFETY PLANE	
	Drawn By	R. ZWEIGLER	Scale	Company
			BYER GEOTECHNICAL, INC.	
Date	3/11/15		File Name	21898 Section 6.slim

24	118.822	720.287	3115.1	0	0
25	120.411	717.644	2110.5	0	0
26	122	715	0	0	0

List Of Coordinates

External Boundary

X	Y
115	778
100	778
89	780
71	785
55	790
38	795
0	800
0	780
0	630
210	630
210	715
122	715
118	758
116	773

Material Boundary

X	Y
0	780
118	758

Material Boundary

X	Y
100	778
116	773

 <p>BYER GEOTECHNICAL INC.</p>	<i>Project</i> BG 21898 HARVARD WESTLAKE SECTION 6			
	<i>Analysis Description</i> CALCULATE THE LOCATION OF THE 1.5 FACTOR OF SAFETY PLANE			
	<i>Drawn By</i> R. ZWEIGLER	<i>Scale</i>	<i>Company</i> BYER GEOTECHNICAL, INC.	
	<i>Date</i> 3/11/15		<i>File Name</i> 21898 Section 6.slim	

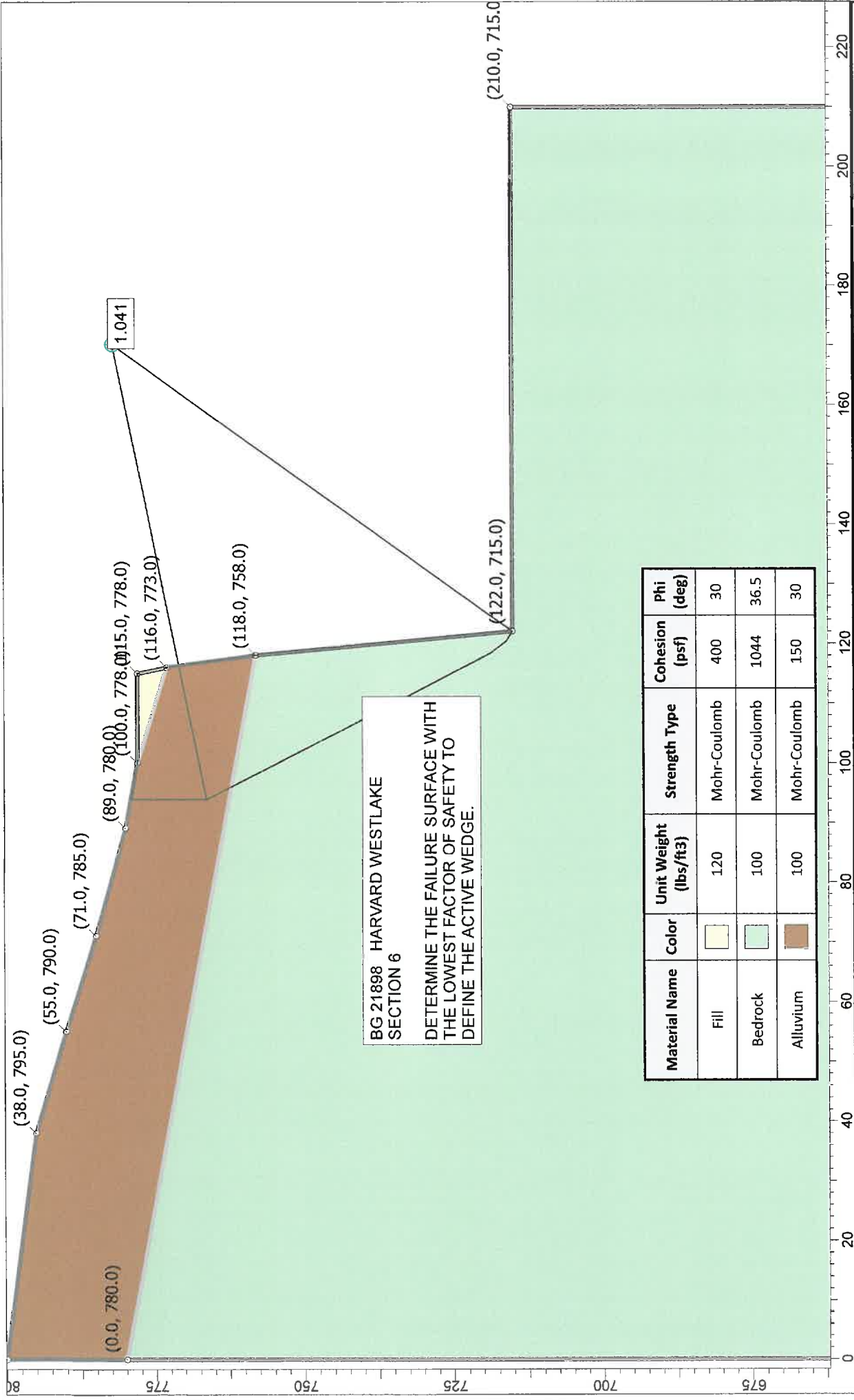



**BYER
GEOTECHNICAL
INC.**

Project
BG 21898 HARVARD WESTLAKE SECTION 6

Analysis Description
CALCULATE THE LOCATION OF THE MOST CRITICAL FAILURE THROUGH THE SOIL NAIL WALLS

Drawn By
R. ZWEIGLER

Date
5/18/15

Company
BYER GEOTECHNICAL, INC.

Scale
1:267

File Name
21898 Section 6 ver2 active wedge.slm

Slide Analysis Information

BG 21898 HARVARD WESTLAKE SECTION 6

Project Summary

File Name: 21898 Section 6 ver2 active wedge
Slide Modeler Version: 6.035
Project Title: BG 21898 HARVARD WESTLAKE SECTION 6
Analysis: CALCULATE THE LOCATION OF THE MOST CRITICAL FAILURE THROUGH THE SOIL NAIL WALLS
Author: R. ZWEIGLER
Company: BYER GEOTECHNICAL, INC.
Date Created: 5/18/15

General Settings

Units of Measurement: Imperial Units
Time Units: days
Permeability Units: feet/second
Failure Direction: Left to Right
Data Output: Standard
Maximum Material Properties: 20
Maximum Support Properties: 20

Analysis Options

Analysis Methods Used

Janbu corrected

Number of slices: 25
Tolerance: 0.005
Maximum number of iterations: 50
Check malpha < 0.2: Yes
Initial trial value of FS: 1
Steffensen Iteration: Yes

Groundwater Analysis

Groundwater Method: Water Surfaces
Pore Fluid Unit Weight: 62.4 lbs/ft³
Advanced Groundwater Method: None

Random Numbers

 BYER GEOTECHNICAL INC.	<i>Project</i> BG 21898 HARVARD WESTLAKE SECTION 6		
	<i>Analysis Description</i> CALCULATE THE LOCATION OF THE MOST CRITICAL FAILURE THROUGH THE SOIL NAIL WALLS		
	<i>Drawn By</i> R. ZWEIGLER	<i>Scale</i>	<i>Company</i> BYER GEOTECHNICAL, INC.
	<i>Date</i> 5/18/15	<i>File Name</i> 21898 Section 6 ver2 active wedge.slim	



SLIDEINTERPRET 6.035

Surface Options

Tension Crack

Tension crack Water level: filled with water

Material Properties

Property	Fill	Bedrock	Alluvium
Color			
Strength Type	Mohr-Coulomb	Mohr-Coulomb	Mohr-Coulomb
Unit Weight [lbs/ft3]	120	100	100
Cohesion [psf]	400	1044	150
Friction Angle [deg]	30	36.5	30
Water Surface	None	None	None
Ru Value	0	0	0

Global Minimums

Method: janbu corrected

FS: 1.041130
 Axis Location: 170.199, 782.043
 Left Slip Surface Endpoint: 93.803, 766.287
 Right Slip Surface Endpoint: 122.000, 715.000
 Left Slope Intercept: 93.803 779.127
 Right Slope Intercept: 122.000 715.000
 Resisting Horizontal Force=41567.9 lb
 Driving Horizontal Force=39925.8 lb
 Total Slice Area=908.89 ft2

Global Minimum Coordinates

Method: janbu corrected

X	Y
93.8034	766.287
98.629	756.864
107.31	739.912
118.312	718.679

 BYER GEOTECHNICAL INC.	Project			BG 21898 HARVARD WESTLAKE SECTION 6		
	Analysis Description					CALCULATE THE LOCATION OF THE MOST CRITICAL FAILURE THROUGH THE SOIL NAIL WALLS
	Drawn By	R. ZWEIGLER	Scale	Company		BYER GEOTECHNICAL, INC.
	Date	5/18/15		File Name	21898 Section 6 ver2 active wedge.slim	

Valid / Invalid Surfaces

Method: janbu corrected

Number of Valid Surfaces: 1

Number of Invalid Surfaces: 0

Slice Data

Global Minimum Query (janbu corrected) - Safety Factor: 1.04113

Slice Number	Width [ft]	Weight [lbs]	Base Material	Base Cohesion [psf]	Base Friction Angle [degrees]	Shear Stress [psf]	Shear Strength [psf]	Base Normal Stress [psf]	Pore Pressure [psf]	Effective Normal Stress [psf]
1	1.06895	1473.64	Alluvium	150	30	433.492	451.322	521.907	0	521.907
2	1.06895	1675.99	Alluvium	150	30	483.578	503.468	612.225	0	612.225
3	1.34385	2394.09	Bedrock	1044	36.5	943.6	982.41	-83.2336	0	-83.2336
4	1.34385	2713.9	Bedrock	1044	36.5	1013.94	1055.65	15.7375	0	15.7375
5	1.08517	2424.9	Bedrock	1044	36.5	1077.51	1121.83	105.183	0	105.183
6	1.08517	2641.25	Bedrock	1044	36.5	1136.44	1183.18	188.094	0	188.094
7	1.08517	2877.56	Bedrock	1044	36.5	1200.81	1250.2	278.658	0	278.658
8	1.08517	3114.87	Bedrock	1044	36.5	1265.45	1317.49	369.605	0	369.605
9	1.08517	3352.18	Bedrock	1044	36.5	1330.08	1384.79	460.552	0	460.552
10	1.08517	3589.49	Bedrock	1044	36.5	1394.72	1452.09	551.499	0	551.499
11	1.08517	3826.8	Bedrock	1044	36.5	1459.36	1519.38	642.446	0	642.446
12	1.08517	4064.11	Bedrock	1044	36.5	1524	1586.68	733.388	0	733.388
13	1.10014	4361.06	Bedrock	1044	36.5	1599.55	1665.34	839.697	0	839.697
14	1.10014	4602.23	Bedrock	1044	36.5	1664.79	1733.26	931.483	0	931.483
15	1.10014	4843.39	Bedrock	1044	36.5	1730.02	1801.18	1023.27	0	1023.27
16	1.10014	5084.55	Bedrock	1044	36.5	1795.26	1869.1	1115.06	0	1115.06
17	1.10014	5325.71	Bedrock	1044	36.5	1860.5	1937.02	1206.84	0	1206.84
18	1.10014	5566.88	Bedrock	1044	36.5	1925.73	2004.94	1298.63	0	1298.63
19	1.10014	5808	Bedrock	1044	36.5	1990.95	2072.84	1390.4	0	1390.4
20	1.10014	5677.64	Bedrock	1044	36.5	1955.69	2036.13	1340.79	0	1340.79
21	1.10014	5079.87	Bedrock	1044	36.5	1793.99	1867.78	1113.27	0	1113.27
22	1.10014	4389.93	Bedrock	1044	36.5	1607.36	1673.47	850.686	0	850.686
23	1.05543	3270.01	Bedrock	1044	36.5	1656.19	1724.31	919.387	0	919.387
24	1.05543	2217.34	Bedrock	1044	36.5	1289.86	1342.91	403.949	0	403.949
25	1.57736	1263.61	Bedrock	1044	36.5	1102.31	1147.64	140.067	0	140.067

Interslice Data

 BYER GEOTECHNICAL INC.	Project			BG 21898 HARVARD WESTLAKE SECTION 6													
	Analysis Description						CALCULATE THE LOCATION OF THE MOST CRITICAL FAILURE THROUGH THE SOIL NAIL WALLS										
	Drawn By			R. ZWEIGLER			Scale			Company			BYER GEOTECHNICAL, INC.				
	Date						5/18/15						File Name			21898 Section 6 ver2 active wedge.slim	
SLIDEINTERPRET 6.035																	

Slice Number	X coordinate [ft]	Y coordinate - Bottom [ft]	Interslice Normal Force [lbs]	Interslice Shear Force [lbs]	Interslice Force Angle [degrees]
1	93.8034	766.287	5143.24	0	0
2	94.8723	764.2	5763.69	0	0
3	95.9413	762.113	6518.48	0	0
4	97.2851	759.488	5016.75	0	0
5	98.629	756.864	3679.06	0	0
6	99.7141	754.745	2718.59	0	0
7	100.799	752.626	1869.09	0	0
8	101.884	750.507	1140.82	0	0
9	102.97	748.388	534.269	0	0
10	104.055	746.269	49.4509	0	0
11	105.14	744.15	-313.637	0	0
12	106.225	742.031	-554.994	0	0
13	107.31	739.912	-674.621	0	0
14	108.41	737.789	-672.573	0	0
15	109.511	735.665	-548.262	0	0
16	110.611	733.542	-301.689	0	0
17	111.711	731.419	67.1464	0	0
18	112.811	729.295	558.245	0	0
19	113.911	727.172	1171.61	0	0
20	115.011	725.049	1907.21	0	0
21	116.111	722.925	2576.73	0	0
22	117.212	720.802	2943.19	0	0
23	118.312	718.679	2959.87	0	0
24	119.367	717.307	2452.25	0	0
25	120.423	715.935	1628.74	0	0
26	122	715	0	0	0

List Of Coordinates

Tension Crack

X	Y
0	785.413
117.54	761.448

External Boundary

X	Y
115	778
100	778

 BYER GEOTECHNICAL INC.	<i>Project</i> BG 21898 HARVARD WESTLAKE SECTION 6		
	<i>Analysis Description</i> CALCULATE THE LOCATION OF THE MOST CRITICAL FAILURE THROUGH THE SOIL NAIL WALLS		
	<i>Drawn By</i> R. ZWEIGLER	<i>Scale</i>	<i>Company</i> BYER GEOTECHNICAL, INC.
	<i>Date</i> 5/18/15		<i>File Name</i> 21898 Section 6 ver2 active wedge.slim
<small>SLIDEINTERPRET 6.035</small>			

89	780
71	785
55	790
38	795
0	800
0	780
0	630
210	630
210	715
122	715
118	758
116	773

Material Boundary

X	Y
0	780
118	758

Material Boundary

X	Y
100	778
116	773

 <p>BYER GEOTECHNICAL INC.</p>	<i>Project</i>		
	BG 21898 HARVARD WESTLAKE SECTION 6		
	<i>Analysis Description</i>		
	CALCULATE THE LOCATION OF THE MOST CRITICAL FAILURE THROUGH THE SOIL NAIL WALLS		
<i>Drawn By</i>	R. ZWEIGLER	<i>Scale</i>	<i>Company</i>
			BYER GEOTECHNICAL, INC.
<i>Date</i>	5/18/15		<i>File Name</i>
			21898 Section 6 ver2 active wedge.slim

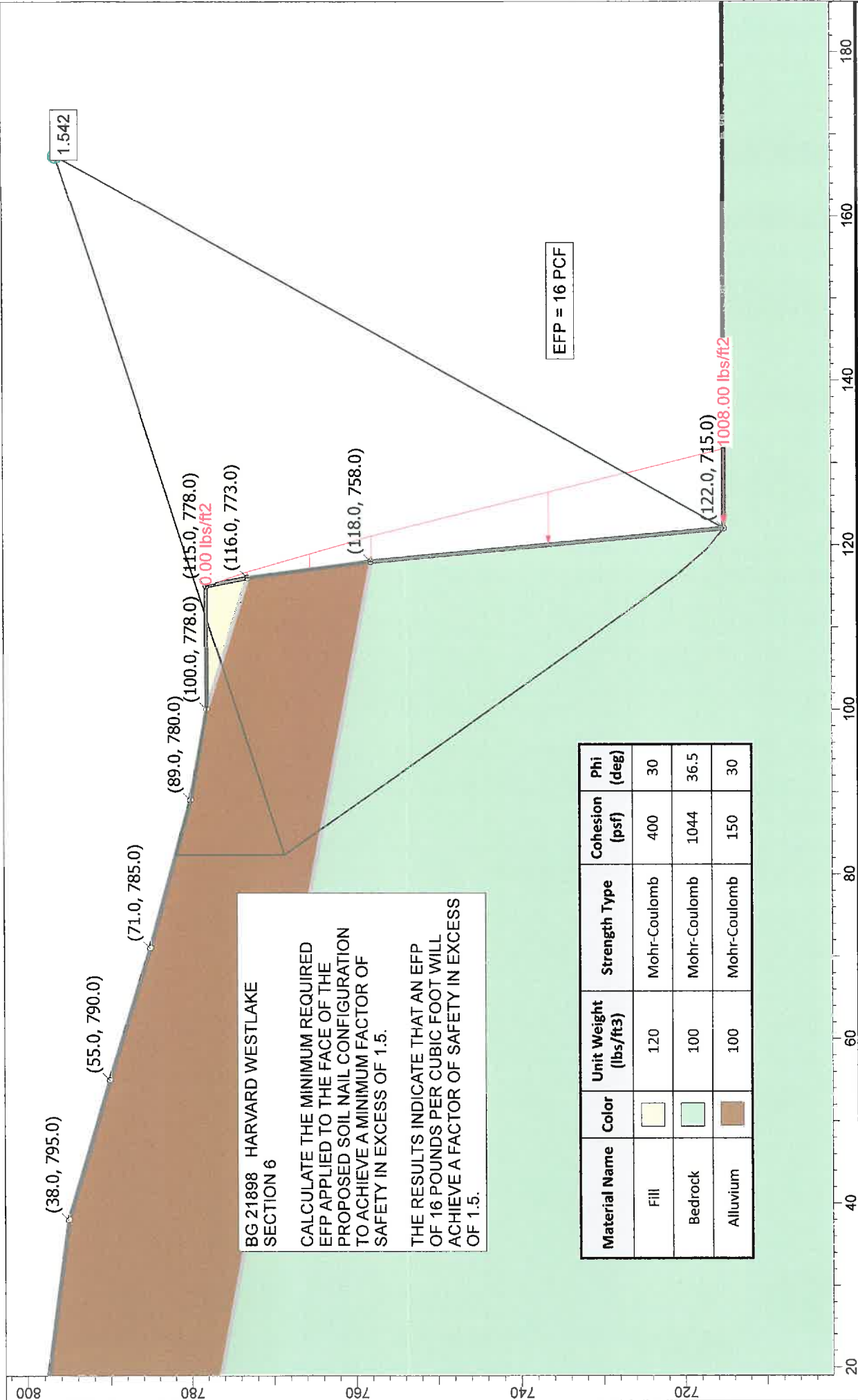

BG 21898 HARVARD WESTLAKE SECTION 6

CALCULATE THE MINIMUM REQUIRED EFP APPLIED TO THE FACE OF THE PROPOSED SOIL NAIL CONFIGURATION TO ACHIEVE A MINIMUM FACTOR OF SAFETY IN EXCESS OF 1.5.

THE RESULTS INDICATE THAT AN EFP OF 16 POUNDS PER CUBIC FOOT WILL ACHIEVE A FACTOR OF SAFETY IN EXCESS OF 1.5.

Material Name	Color	Unit Weight (lbs/ft ³)	Strength Type	Cohesion (psf)	Phi (deg)
Fill		120	Mohr-Coulomb	400	30
Bedrock		100	Mohr-Coulomb	1044	36.5
Alluvium		100	Mohr-Coulomb	150	30

Project BG 21898 HARVARD WESTLAKE SECTION 6

Analysis Description CALCULATE THE MINIMUM REQUIRED EFP APPLIED TO SOIL NAIL WALLS TO ACHIEVE FS=1.5

Drawn By R. ZWEIGLER **Scale** 1:195 **Company** BYER GEOTECHNICAL, INC.

Date 5/18/15 **File Name** 21898 Section 6 ver2 efp.slm

SLIDEINTERPRET 6.035

Slide Analysis Information

BG 21898 HARVARD WESTLAKE SECTION 6

Project Summary

File Name: 21898 Section 6 ver2 efp
Slide Modeler Version: 6.035
Project Title: BG 21898 HARVARD WESTLAKE SECTION 6
Analysis: CALCULATE THE MINIMUM REQUIRED EFP APPLIED TO SOIL NAIL WALLS TO ACHIEVE FS=1.5
Author: R. ZWEIGLER
Company: BYER GEOTECHNICAL, INC.
Date Created: 5/18/15

General Settings

Units of Measurement: Imperial Units
Time Units: days
Permeability Units: feet/second
Failure Direction: Left to Right
Data Output: Standard
Maximum Material Properties: 20
Maximum Support Properties: 20

Analysis Options

Analysis Methods Used

Spencer

Number of slices: 25
Tolerance: 0.005
Maximum number of iterations: 50
Check $\alpha < 0.2$: Yes
Initial trial value of FS: 1
Steffensen Iteration: Yes

Groundwater Analysis

Groundwater Method: Water Surfaces
Pore Fluid Unit Weight: 62.4 lbs/ft³
Advanced Groundwater Method: None

Random Numbers

 BYER GEOTECHNICAL INC. <small>SLIDEINTERPRET 6.035</small>	<i>Project</i> BG 21898 HARVARD WESTLAKE SECTION 6		
	<i>Analysis Description</i> CALCULATE THE MINIMUM REQUIRED EFP APPLIED TO SOIL NAIL WALLS TO ACHIEVE FS=1.5		
	<i>Drawn By</i> R. ZWEIGLER	<i>Scale</i>	<i>Company</i> BYER GEOTECHNICAL, INC.
	<i>Date</i> 5/18/15	<i>File Name</i> 21898 Section 6 ver2 efp.slim	

Surface Options

Loading

1 Distributed Load present

Distributed Load 1

Distribution: Triangular
 Magnitude 1 [psf]: 1008
 Magnitude 2 [psf]: 0
 Orientation: Horizontal

Tension Crack

Tension crack Water level: filled with water

Material Properties

Property	Fill	Bedrock	Alluvium
Color	<input type="checkbox"/>	<input type="checkbox"/>	<input type="checkbox"/>
Strength Type	Mohr-Coulomb	Mohr-Coulomb	Mohr-Coulomb
Unit Weight [lbs/ft3]	120	100	100
Cohesion [psf]	400	1044	150
Friction Angle [deg]	30	36.5	30
Water Surface	None	None	None
Ru Value	0	0	0

Global Minimums

Method: spencer

FS: 1.542440
 Axis Location: 167.431, 796.227
 Left Slip Surface Endpoint: 82.261, 768.641
 Right Slip Surface Endpoint: 122.000, 715.000
 Left Slope Intercept: 82.261 781.872
 Right Slope Intercept: 122.000 715.000
 Resisting Moment=1.19663e+007 lb-ft
 Driving Moment=7.75802e+006 lb-ft

 BYER GEOTECHNICAL INC.	Project BG 21898 HARVARD WESTLAKE SECTION 6		
	Analysis Description CALCULATE THE MINIMUM REQUIRED EFP APPLIED TO SOIL NAIL WALLS TO ACHIEVE FS=1.5		
	Drawn By R. ZWEIGLER	Scale	Company BYER GEOTECHNICAL, INC.
	Date 5/18/15	File Name 21898 Section 6 ver2 efp.slim	

Resisting Horizontal Force=83156.4 lb
 Driving Horizontal Force=53912.2 lb
 Total Slice Area=1318.14 ft²

Global Minimum Coordinates

Method: spencer

X	Y
82.2612	768.641
92.1552	754.586
96.471	748.455
102.884	739.501
116.374	720.667
119.616	716.913
122	715

Valid / Invalid Surfaces

Method: spencer

Number of Valid Surfaces: 1
 Number of Invalid Surfaces: 0

Slice Data

Global Minimum Query (spencer) - Safety Factor: 1.54244

Slice Number	Width [ft]	Weight [lbs]	Base Material	Base Cohesion [psf]	Base Friction Angle [degrees]	Shear Stress [psf]	Shear Strength [psf]	Base Normal Stress [psf]	Pore Pressure [psf]	Effective Normal Stress [psf]
1	1.6115	2280.59	Alluvium	150	30	208.28	321.26	296.631	0	296.631
2	1.6115	2577.36	Alluvium	150	30	410.838	633.693	837.781	0	837.781
3	1.66775	2979.82	Bedrock	1044	36.5	924.719	1426.32	516.68	0	516.68
4	1.66775	3297.67	Bedrock	1044	36.5	972.933	1500.69	617.181	0	617.181
5	1.66775	3626.14	Bedrock	1044	36.5	1022.76	1577.54	721.041	0	721.041
6	1.66775	3970.52	Bedrock	1044	36.5	1075	1658.12	829.934	0	829.934
7	1.43861	3701.76	Bedrock	1044	36.5	1123.67	1733.19	931.39	0	931.39
8	1.43861	3958.13	Bedrock	1044	36.5	1168.75	1802.73	1025.36	0	1025.36
9	1.43861	4214.5	Bedrock	1044	36.5	1213.83	1872.27	1119.34	0	1119.34
10	1.60334	4996.03	Bedrock	1044	36.5	1270.58	1959.79	1237.62	0	1237.62
11	1.60334	5308.21	Bedrock	1044	36.5	1320.28	2036.46	1341.23	0	1341.23
12	1.60334	5640.43	Bedrock	1044	36.5	1373.18	2118.05	1451.5	0	1451.5
13	1.60334	6014.14	Bedrock	1044	36.5	1432.69	2209.84	1575.54	0	1575.54
14	1.68621	6729.57	Bedrock	1044	36.5	1493.94	2304.32	1703.22	0	1703.22

 BYER GEOTECHNICAL INC.	Project		BG 21898 HARVARD WESTLAKE SECTION 6		
	Analysis Description				CALCULATE THE MINIMUM REQUIRED EFP APPLIED TO SOIL NAIL WALLS TO ACHIEVE FS=1.5
	Drawn By	R. ZWEIGLER	Scale	Company BYER GEOTECHNICAL, INC.	
	Date	5/18/15		File Name	21898 Section 6 ver2 efp.slim

15	1.68621	7144.32	Bedrock	1044	36.5	1556.74	2401.18	1834.12	0	1834.12
16	1.68621	7559.07	Bedrock	1044	36.5	1619.54	2498.04	1965.02	0	1965.02
17	1.68621	7973.82	Bedrock	1044	36.5	1682.33	2594.89	2095.91	0	2095.91
18	1.68621	8388.57	Bedrock	1044	36.5	1745.12	2691.75	2226.81	0	2226.81
19	1.68621	8803.32	Bedrock	1044	36.5	1807.92	2788.61	2357.7	0	2357.7
20	1.68621	9218.07	Bedrock	1044	36.5	1870.72	2885.47	2488.6	0	2488.6
21	1.68621	9055.48	Bedrock	1044	36.5	1863.38	2874.15	2473.3	0	2473.3
22	1.62079	7194.45	Bedrock	1044	36.5	1853.65	2859.15	2453.04	0	2453.04
23	1.62079	5104.28	Bedrock	1044	36.5	1701.36	2624.25	2135.59	0	2135.59
24	1.19219	2120.83	Bedrock	1044	36.5	1702.85	2626.54	2138.68	0	2138.68
25	1.19219	706.944	Bedrock	1044	36.5	1478.67	2280.76	1671.38	0	1671.38

Interslice Data

Global Minimum Query (spencer) - Safety Factor: 1.54244

Slice Number	X coordinate [ft]	Y coordinate - Bottom [ft]	Interslice Normal Force [lbs]	Interslice Shear Force [lbs]	Interslice Force Angle [degrees]
1	82.2612	768.641	5462.01	0	0
2	83.8727	766.351	5805.42	1325.77	12.8639
3	85.4842	764.062	7061.22	1612.55	12.8639
4	87.1519	761.693	6743.1	1539.9	12.8639
5	88.8197	759.324	6582.67	1503.27	12.8639
6	90.4874	756.955	6585.21	1503.85	12.8639
7	92.1552	754.586	6758.6	1543.44	12.8639
8	93.5938	752.542	7045.48	1608.96	12.8639
9	95.0324	750.499	7459.56	1703.52	12.8639
10	96.471	748.455	8000.83	1827.13	12.8639
11	98.0744	746.216	8734.14	1994.59	12.8639
12	99.6777	743.978	9619.71	2196.83	12.8639
13	101.281	741.739	10667.3	2436.07	12.8639
14	102.884	739.501	11897.2	2716.93	12.8639
15	104.571	737.146	13387.9	3057.36	12.8639
16	106.257	734.792	15080.9	3443.99	12.8639
17	107.943	732.438	16976.2	3876.82	12.8639
18	109.629	730.084	19073.8	4355.84	12.8639
19	111.315	727.729	21373.7	4881.05	12.8639
20	113.002	725.375	23875.8	5452.45	12.8639
21	114.688	723.021	26580.2	6070.05	12.8639
22	116.374	720.667	28761.3	6568.14	12.8639
23	117.995	718.79	27620.3	6307.57	12.8639
24	119.616	716.913	20831.2	4757.17	12.8639
25	120.808	715.956	11822.1	2699.77	12.8638
26	122	715	0	0	0

 BYER GEOTECHNICAL INC.	<i>Project</i>			BG 21898 HARVARD WESTLAKE SECTION 6		
	<i>Analysis Description</i>					CALCULATE THE MINIMUM REQUIRED EFP APPLIED TO SOIL NAIL WALLS TO ACHIEVE FS=1.5
	<i>Drawn By</i>		R. ZWEIGLER	<i>Scale</i>		<i>Company</i>
	<i>Date</i>		5/18/15	<i>File Name</i>		21898 Section 6 ver2 efp.slim

List Of Coordinates

Distributed Load

X	Y
122	715
118	758
116	773
115	778

Tension Crack

X	Y
0	785.413
117.54	761.448

External Boundary

X	Y
115	778
100	778
89	780
71	785
55	790
38	795
0	800
0	780
0	630
210	630
210	715
122	715
118	758
116	773

Material Boundary

X	Y
0	780
118	758

Material Boundary

X	Y
---	---

 BYER GEOTECHNICAL INC.	<i>Project</i>		
	BG 21898 HARVARD WESTLAKE SECTION 6		
	<i>Analysis Description</i>		
	CALCULATE THE MINIMUM REQUIRED EFP APPLIED TO SOIL NAIL WALLS TO ACHIEVE FS=1.5		
<i>Drawn By</i>	R. ZWEIGLER	<i>Scale</i>	<i>Company</i>
			BYER GEOTECHNICAL, INC.
<i>Date</i>	5/18/15		<i>File Name</i>
			21898 Section 6 ver2 efp.slim

100 778

116 773



BYER
GEOTECHNICAL
INC.

SLIDEINTERPRET 6.035

<i>Project</i>			
BG 21898 HARVARD WESTLAKE SECTION 6			
<i>Analysis Description</i>			
CALCULATE THE MINIMUM REQUIRED EFP APPLIED TO SOIL NAIL WALLS TO ACHIEVE FS=1.5			
<i>Drawn By</i>	R. ZWEIGLER	<i>Scale</i>	<i>Company</i>
			BYER GEOTECHNICAL, INC.
<i>Date</i>	5/18/15	<i>File Name</i>	21898 Section 6 ver2 efp.slim

BG 21898 HARVARD WESTLAKE SECTION 6

CALCULATE THE MINIMUM REQUIRED EFP APPLIED TO THE FACE OF THE PROPOSED SOIL NAIL CONFIGURATION TO ACHIEVE A FACTOR OF SAFETY OF 1.0 UNDER SEISMIC LOADING.

THE RESULTS INDICATE THAT AN EFP OF 16 PCF WILL ACHIEVE A FACTOR OF SAFETY IN EXCESS OF 1.0.

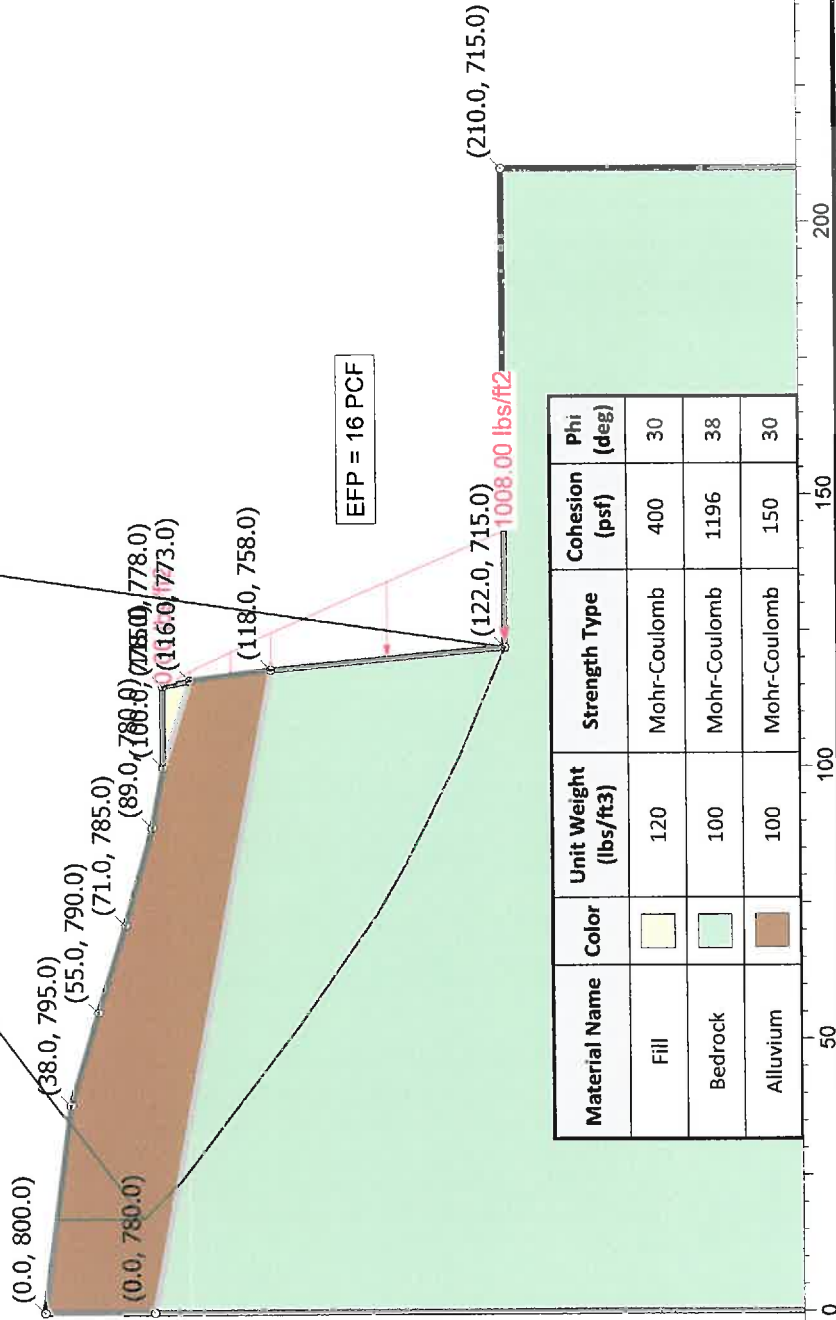
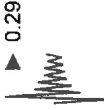

Material Name	Color	Unit Weight (lbs/ft3)	Strength Type	Cohesion (psf)	Phi (deg)
Fill		120	Mohr-Coulomb	400	30
Bedrock		100	Mohr-Coulomb	1196	38
Alluvium		100	Mohr-Coulomb	150	30

BYER GEOTECHNICAL INC.

SLIDENTERPRET 6.035

Project: BG 21898 HARVARD WESTLAKE SECTION 6

Analysis Description: CALCULATE THE MINIMUM REQUIRED EFP APPLIED TO SOIL NAIL WALLS TO ACHIEVE FS=1.0 (SEISMIC)

Drawn By: R. ZWEIGLER

Date: 5/18/15

Scale: 1:425

Company: BYER GEOTECHNICAL, INC.

File Name: 21898 Section 6 ver2 efp EQ.slim

Slide Analysis Information

BG 21898 HARVARD WESTLAKE SECTION 6

Project Summary

File Name: 21898 Section 6 ver2 efp EQ
Slide Modeler Version: 6.035
Project Title: BG 21898 HARVARD WESTLAKE SECTION 6
Analysis: CALCULATE THE MINIMUM REQUIRED EFP APPLIED TO SOIL NAIL WALLS TO ACHIEVE FS=1.0 (SEISMIC)
Author: R. ZWEIGLER
Company: BYER GEOTECHNICAL, INC.
Date Created: 5/18/15

General Settings

Units of Measurement: Imperial Units
Time Units: days
Permeability Units: feet/second
Failure Direction: Left to Right
Data Output: Standard
Maximum Material Properties: 20
Maximum Support Properties: 20

Analysis Options

Analysis Methods Used

Spencer

Number of slices: 25
Tolerance: 0.005
Maximum number of iterations: 50
Check malpha < 0.2: Yes
Initial trial value of FS: 1
Steffensen Iteration: Yes

Groundwater Analysis

Groundwater Method: Water Surfaces
Pore Fluid Unit Weight: 62.4 lbs/ft³
Advanced Groundwater Method: None

Random Numbers

 BYER GEOTECHNICAL INC.	<i>Project</i> BG 21898 HARVARD WESTLAKE SECTION 6		
	<i>Analysis Description</i> CALCULATE THE MINIMUM REQUIRED EFP APPLIED TO SOIL NAIL WALLS TO ACHIEVE FS=1.0 (SEISMIC)		
	<i>Drawn By</i> R. ZWEIGLER	<i>Scale</i>	<i>Company</i> BYER GEOTECHNICAL, INC.
	<i>Date</i> 5/18/15	<i>File Name</i> 21898 Section 6 ver2 efp EQ.slim	
SLIDEINTERPRET 6.035			

Surface Options

Loading

Seismic Load Coefficient (Horizontal): 0.29
 1 Distributed Load present



Distributed Load 1

Distribution: Triangular
 Magnitude 1 [psf]: 1008
 Magnitude 2 [psf]: 0
 Orientation: Horizontal

Tension Crack

Tension crack Water level: filled with water

Material Properties

Property	Fill	Bedrock	Alluvium
Color			
Strength Type	Mohr-Coulomb	Mohr-Coulomb	Mohr-Coulomb
Unit Weight [lbs/ft ³]	120	100	100
Cohesion [psf]	400	1196	150
Friction Angle [deg]	30	38	30
Water Surface	None	None	None
Ru Value	0	0	0

Global Minimums

Method: spencer

FS: 1.350910
 Axis Location: 146.108, 879.183
 Left Slip Surface Endpoint: 16.999, 781.947
 Right Slip Surface Endpoint: 122.000, 715.002
 Left Slope Intercept: 16.999 797.763
 Right Slope Intercept: 122.000 715.002
 Resisting Moment=6.28132e+007 lb-ft

 BYER GEOTECHNICAL INC.	Project			BG 21898 HARVARD WESTLAKE SECTION 6	
	Analysis Description: THE MINIMUM REQUIRED EFP APPLIED TO SOIL NAIL WALLS TO ACHIEVE FS=1.0 (SEISMIC)				
	Drawn By	R. ZWEIGLER	Scale	Company	BYER GEOTECHNICAL, INC.
	Date	5/18/15		File Name	21898 Section 6 ver2 efp EQ.slim
SLIDEINTERPRET 6.035					

Driving Moment=4.64969e+007 lb-ft
 Resisting Horizontal Force=342434 lb
 Driving Horizontal Force=253484 lb
 Total Slice Area=4283.09 ft²

Global Minimum Coordinates

Method: spencer

X	Y
16.9989	781.947
24.1366	775.007
52.8747	752.784
72.954	738.589
82.3847	733.157
102.173	723.284
122	715.002

Valid / Invalid Surfaces

Method: spencer

Number of Valid Surfaces: 1
 Number of Invalid Surfaces: 1

Error Codes:

Error Code -111 reported for 1 surface

Error Codes

The following errors were encountered during the computation:

-111 = safety factor equation did not converge

Slice Data

Global Minimum Query (spencer) - Safety Factor: 1.35091

Slice Number	Width [ft]	Weight [lbs]	Base Material	Base Cohesion [psf]	Base Friction Angle [degrees]	Shear Stress [psf]	Shear Strength [psf]	Base Normal Stress [psf]	Pore Pressure [psf]	Effective Normal Stress [psf]
1	6.51053	12079	Alluvium	150	30	0.820928	1.109	-257.886	0	-257.886
2	0.627139	1351.7	Bedrock	1196	38	1338.91	1808.75	784.283	0	784.283
3	4.78969	11185.8	Bedrock	1196	38	1538.18	2077.94	1128.84	0	1128.84
4	4.78969	12657.9	Bedrock	1196	38	1598.74	2159.76	1233.56	0	1233.56
5	4.78969	14128	Bedrock	1196	38	1659.22	2241.46	1338.13	0	1338.13

 BYER GEOTECHNICAL INC.	Project		BG 21898 HARVARD WESTLAKE SECTION 6		
	ANALYZE AND DESIGN THE MINIMUM REQUIRED EFP APPLIED TO SOIL NAIL WALLS TO ACHIEVE FS=1.0 (SFISMTC)				
	Drawn By	R. ZWEIGLER	Scale	Company	BYER GEOTECHNICAL, INC.
	Date	5/18/15	File Name	21898 Section 6 ver2 efp EQ.slim	

6	4.78969	15376.5	Bedrock	1196	38	1710.58	2310.84	1426.93	0	1426.93
7	4.78969	16475.8	Bedrock	1196	38	1755.81	2371.94	1505.13	0	1505.13
8	4.78969	17575	Bedrock	1196	38	1801.03	2433.03	1583.33	0	1583.33
9	4.01587	15526.1	Bedrock	1196	38	1940.78	2621.82	1824.96	0	1824.96
10	4.01587	16166.3	Bedrock	1196	38	1974.82	2667.8	1883.81	0	1883.81
11	4.01587	16802.4	Bedrock	1196	38	2008.63	2713.48	1942.28	0	1942.28
12	4.01587	17438.5	Bedrock	1196	38	2042.45	2759.16	2000.75	0	2000.75
13	4.01587	18081.3	Bedrock	1196	38	2076.61	2805.31	2059.84	0	2059.84
14	4.71534	21959.9	Bedrock	1196	38	2401.12	3243.7	2620.93	0	2620.93
15	4.71534	22623	Bedrock	1196	38	2437.05	3292.24	2683.06	0	2683.06
16	3.95771	19439.6	Bedrock	1196	38	2707.18	3657.15	3150.12	0	3150.12
17	3.95771	19794.1	Bedrock	1196	38	2733.06	3692.12	3194.89	0	3194.89
18	3.95771	20256.9	Bedrock	1196	38	2766.87	3737.79	3253.33	0	3253.33
19	3.95771	20753.6	Bedrock	1196	38	2803.14	3786.79	3316.07	0	3316.07
20	3.95771	21308.1	Bedrock	1196	38	2843.63	3841.49	3386.07	0	3386.07
21	3.96531	22128.1	Bedrock	1196	38	3264.65	4410.25	4114.06	0	4114.06
22	3.96531	22883.2	Bedrock	1196	38	3328.52	4496.53	4224.48	0	4224.48
23	3.96531	23638.3	Bedrock	1196	38	3392.39	4582.81	4334.92	0	4334.92
24	3.96531	21307.3	Bedrock	1196	38	3886.02	5249.67	5188.47	0	5188.47
25	3.96531	8123.08	Bedrock	1196	38	7932.99	10716.8	12186	0	12186

Interslice Data

Global Minimum Query (spencer) - Safety Factor: 1.35091

Slice Number	X coordinate [ft]	Y coordinate - Bottom [ft]	Interslice Normal Force [lbs]	Interslice Shear Force [lbs]	Interslice Force Angle [degrees]
1	16.9989	781.947	7804.85	0	0
2	23.5094	775.617	9669.96	13753.1	54.8885
3	24.1366	775.007	9700.5	13796.5	54.8884
4	28.9263	771.303	9758.02	13878.3	54.8884
5	33.716	767.599	10340.3	14706.4	54.8883
6	38.5056	763.896	11446.5	16279.7	54.8884
7	43.2953	760.192	12997.7	18485.8	54.8883
8	48.085	756.488	14940.7	21249.3	54.8884
9	52.8747	752.784	17275.5	24569.9	54.8883
10	56.8906	749.945	19165.1	27257.5	54.8885
11	60.9064	747.106	21270.8	30252.3	54.8884
12	64.9223	744.267	23591.1	33552.4	54.8885
13	68.9382	741.428	26126.2	37157.8	54.8884
14	72.954	738.589	28878.1	41071.7	54.8884
15	77.6694	735.873	31043.3	44151.1	54.8884
16	82.3847	733.157	33400.1	47503.1	54.8884
17	86.3424	731.182	34543.8	49129.7	54.8884

 <p>BYER GEOTECHNICAL INC.</p>	Project			BG 21898 HARVARD WESTLAKE SECTION 6			
	Analysis Description						THE MINIMUM REQUIRED EFP APPLIED TO SOIL NAIL WALLS TO ACHIEVE FS=1.0 (SEISMIC)
	Drawn By		R. ZWEIGLER		Scale	Company	BYER GEOTECHNICAL, INC.
	Date			5/18/15		File Name	21898 Section 6 ver2 efp EQ.slim

SLIDEINTERPRET 6.035

18	90.3001	729.208	35776.2	50882.5	54.8884
19	94.2579	727.233	37124.5	52800.1	54.8884
20	98.2156	725.258	38597.1	54894.5	54.8884
21	102.173	723.284	40208.5	57186.3	54.8884
22	106.139	721.627	40494.7	57593.4	54.8884
23	110.104	719.971	40929.6	58211.9	54.8884
24	114.069	718.315	41513.1	59041.9	54.8885
25	118.035	716.658	37503.1	53338.5	54.8884
26	122	715.002	0	0	0

List Of Coordinates

Distributed Load

X	Y
122	715
118	758
116	773
115	778

Tension Crack

X	Y
0	785.413
117.54	761.448

External Boundary

X	Y
115	778
100	778
89	780
71	785
55	790
38	795
0	800
0	780
0	630
210	630
210	715
122	715
118	758
116	773

 <p>BYER GEOTECHNICAL INC.</p>	<i>Project</i> BG 21898 HARVARD WESTLAKE SECTION 6			
	<i>Analysis Description</i> ANALYZE THE MINIMUM REQUIRED EFP APPLIED TO SOIL NAIL WALLS TO ACHIEVE FS=1.0 (SEISMIC)			
	<i>Drawn By</i> R. ZWEIGLER	<i>Scale</i>	<i>Company</i> BYER GEOTECHNICAL, INC.	
	<i>Date</i> 5/18/15		<i>File Name</i> 21898 Section 6 ver2 efp EQ.slim	
SLIDEINTERPRET 6.035				

Material Boundary

X	Y
0	780
118	758

Material Boundary

X	Y
100	778
116	773

 BYER GEOTECHNICAL INC.	<i>Project</i> BG 21898 HARVARD WESTLAKE SECTION 6		
	<i>Analysis Description</i> Determine the minimum required EFP applied to soil nail walls to achieve FS=1.0 (SEISMIC)		
	<i>Drawn By</i> R. ZWEIGLER	<i>Scale</i>	<i>Company</i> BYER GEOTECHNICAL, INC.
	<i>Date</i> 5/18/15	<i>File Name</i> 21898 Section 6 ver2 efp EQ.slim	

BG 21898 HARVARD WESTLAKE
SECTION 6



CALCULATE THE MINIMUM REQUIRED
EFP TO GENERATE A FACTOR OF SAFETY
OF 1.5, APPLIED SO AS TO REPRESENT
THE MASS OF EARTH CONSISTING OF
A SOIL NAIL WALL.

THE RESULTS INDICATE THAT AN EFP
OF 25 PCF WILL ACHIEVE A FACTOR OF
SAFETY OF 1.511.

EFP = 25 PCF

0.00 lbs/ft2

1637.50 lbs/ft2

Material Name	Color	Unit Weight (lbs/ft3)	Strength Type	Cohesion (psf)	Phi (deg)	Water Surface	Ru
Bedrock		100	Mohr-Coulomb	1044	36.5	None	0
Alluvium		100	Mohr-Coulomb	150	30	None	0

Project

BG 21898 HARVARD WESTLAKE SECTION 6

Analysis Description

CALCULATE THE MINIMUM REQUIRED EFP TO REPRESENT SOIL NAIL EARTH BLOCK

Drawn By

R. ZWEIGLER

Company

BYER GEOTECHNICAL, INC.

Date

5/18/15

File Name 21898 Section 6 efp on back of soil nail wall.slm

**BYER
GEOTECHNICAL
INC.**



Slide Analysis Information

BG 21898 HARVARD WESTLAKE SECTION 6

Project Summary

File Name: 21898 Section 6 efp on back of soil nail wall
Slide Modeler Version: 6.035
Project Title: BG 21898 HARVARD WESTLAKE SECTION 6
Analysis: CALCULATE THE MINIMUM REQUIRED EFP TO REPRESENT SOIL NAIL EARTH BLOCK
Author: R. ZWEIGLER
Company: BYER GEOTECHNICAL, INC.
Date Created: 5/18/15

General Settings

Units of Measurement: Imperial Units
Time Units: days
Permeability Units: feet/second
Failure Direction: Left to Right
Data Output: Standard
Maximum Material Properties: 20
Maximum Support Properties: 20

Analysis Options

Analysis Methods Used

Bishop simplified

Number of slices: 25
Tolerance: 0.005
Maximum number of iterations: 50
Check $m\alpha < 0.2$: Yes
Initial trial value of FS: 1
Steffensen Iteration: Yes

Groundwater Analysis

Groundwater Method: Water Surfaces
Pore Fluid Unit Weight: 62.4 lbs/ft³
Advanced Groundwater Method: None

Random Numbers

 BYER GEOTECHNICAL INC.	<i>Project</i> BG 21898 HARVARD WESTLAKE SECTION 6		
	<i>Analysis Description</i> CALCULATE THE MINIMUM REQUIRED EFP TO REPRESENT SOIL NAIL EARTH BLOCK		
	<i>Drawn By</i> R. ZWEIGLER	<i>Scale</i>	<i>Company</i> BYER GEOTECHNICAL, INC.
	<i>Date</i> 5/18/15	<i>File Name</i> 21898 Section 6 efp on back of soil nail wall.slim	

SLIDEINTERPRET 6.035

Surface Options

Surface Type: Circular
 Search Method: Auto Refine Search
 Divisions along slope: 25
 Circles per division: 10
 Number of iterations: 10
 Divisions to use in next iteration: 50%
 Composite Surfaces: Disabled
 Minimum Elevation: Not Defined
 Minimum Depth: Not Defined



Loading

1 Distributed Load present

Distributed Load 1

Distribution: Triangular
 Magnitude 1 [psf]: 0
 Magnitude 2 [psf]: 1637.5
 Orientation: Horizontal

Material Properties

Property	Bedrock	Alluvium
Color		
Strength Type	Mohr-Coulomb	Mohr-Coulomb
Unit Weight [lbs/ft ³]	100	100
Cohesion [psf]	1044	150
Friction Angle [deg]	36.5	30
Water Surface	None	None
Ru Value	0	0

Global Minimums

Method: bishop simplified

FS: 1.511250
 Center: 731.978, 1214.708
 Radius: 815.113
 Left Slip Surface Endpoint: 32.818, 795.682

 BYER GEOTECHNICAL INC.	<i>Project</i> BG 21898 HARVARD WESTLAKE SECTION 6		
	<i>Analysis Description</i> CALCULATE THE MINIMUM REQUIRED EFP TO REPRESENT SOIL NAIL EARTH BLOCK		
	<i>Drawn By</i> R. ZWEIGLER	<i>Scale</i>	<i>Company</i> BYER GEOTECHNICAL, INC.
	<i>Date</i> 5/18/15	<i>File Name</i> 21898 Section 6 efp on back of soil nail wall.slim	

Right Slip Surface Endpoint: 88.000, 715.008
 Left Slope Intercept: 32.818 795.682
 Right Slope Intercept: 88.000 780.500
 Resisting Moment=1.53137e+008 lb-ft
 Driving Moment=1.01331e+008 lb-ft
 Total Slice Area=1914.69 ft2

Valid / Invalid Surfaces

Method: bishop simplified

Number of Valid Surfaces: 7420
 Number of Invalid Surfaces: 0

Slice Data

Global Minimum Query (bishop simplified) - Safety Factor: 1.51125

Slice Number	Width [ft]	Weight [lbs]	Base Material	Base Cohesion [psf]	Base Friction Angle [degrees]	Shear Stress [psf]	Shear Strength [psf]	Base Normal Stress [psf]	Pore Pressure [psf]	Effective Normal Stress [psf]
1	2.22707	378.68	Alluvium	150	30	100.528	151.923	3.33123	0	3.33123
2	2.22707	1131.18	Alluvium	150	30	180.377	272.595	212.341	0	212.341
3	2.22707	1855.83	Alluvium	150	30	257.982	389.876	415.476	0	415.476
4	2.22707	2513.08	Alluvium	150	30	329.078	497.319	601.574	0	601.574
5	2.22707	3156.9	Alluvium	150	30	399.324	603.479	785.45	0	785.45
6	2.22707	3791.82	Alluvium	150	30	469.177	709.044	968.292	0	968.292
7	2.22707	4418.05	Alluvium	150	30	538.633	814.009	1150.1	0	1150.1
8	2.1996	4969.98	Bedrock	1044	36.5	1027.15	1552.29	686.909	0	686.909
9	2.1996	5564.6	Bedrock	1044	36.5	1107.87	1674.26	851.751	0	851.751
10	2.1996	6151.4	Bedrock	1044	36.5	1188.2	1795.66	1015.82	0	1015.82
11	2.1996	6726.1	Bedrock	1044	36.5	1267.57	1915.62	1177.92	0	1177.92
12	2.1996	7288.89	Bedrock	1044	36.5	1345.98	2034.12	1338.07	0	1338.07
13	2.1996	7844.37	Bedrock	1044	36.5	1424	2152.02	1497.4	0	1497.4
14	2.1996	8392.68	Bedrock	1044	36.5	1501.62	2269.32	1655.92	0	1655.92
15	2.1996	8933.97	Bedrock	1044	36.5	1578.83	2386.01	1813.62	0	1813.62
16	2.1996	9468.38	Bedrock	1044	36.5	1655.65	2502.1	1970.51	0	1970.51
17	2.1996	9996.04	Bedrock	1044	36.5	1732.06	2617.58	2126.57	0	2126.57
18	2.1996	10523.2	Bedrock	1044	36.5	1808.89	2733.69	2283.49	0	2283.49
19	2.1996	11060.1	Bedrock	1044	36.5	1887.48	2852.45	2443.97	0	2443.97
20	2.1996	11591.4	Bedrock	1044	36.5	1965.79	2970.8	2603.92	0	2603.92
21	2.1996	12116.5	Bedrock	1044	36.5	2043.73	3088.58	2763.09	0	2763.09
22	2.1996	12635.4	Bedrock	1044	36.5	2121.28	3205.78	2921.47	0	2921.47
23	2.1996	13148.3	Bedrock	1044	36.5	2198.45	3322.41	3079.1	0	3079.1
24	2.1996	13655.3	Bedrock	1044	36.5	2275.24	3438.46	3235.91	0	3235.91
25	2.1996	14156.5	Bedrock	1044	36.5	2351.65	3553.93	3391.97	0	3391.97

 BYER GEOTECHNICAL INC.	Project			BG 21898 HARVARD WESTLAKE SECTION 6																			
	Analysis Description						CALCULATE THE MINIMUM REQUIRED EFP TO REPRESENT SOIL NAIL EARTH BLOCK																
	Drawn By			R. ZWEIGLER			Scale			Company			BYER GEOTECHNICAL, INC.										
	Date						5/18/15						File Name						21898 Section 6 efp on back of soil nail wall.slim				

Interslice Data

Global Minimum Query (bishop simplified) - Safety Factor: 1.51125

Slice Number	X coordinate [ft]	Y coordinate - Bottom [ft]	Interslice Normal Force [lbs]	Interslice Shear Force [lbs]	Interslice Force Angle [degrees]
1	32.8178	795.682	0	0	0
2	35.0449	791.988	-211.54	0	0
3	37.2719	788.338	161.887	0	0
4	39.499	784.73	1086.31	0	0
5	41.7261	781.164	2498.85	0	0
6	43.9531	777.639	4378.94	0	0
7	46.1802	774.152	6709.91	0	0
8	48.4073	770.705	9475.71	0	0
9	50.6069	767.337	9530.42	0	0
10	52.8065	764.004	9932.26	0	0
11	55.0061	760.707	10668.5	0	0
12	57.2057	757.444	11724.2	0	0
13	59.4052	754.215	13084.9	0	0
14	61.6048	751.019	14739.4	0	0
15	63.8044	747.855	16676.4	0	0
16	66.004	744.722	18885.2	0	0
17	68.2036	741.621	21355.5	0	0
18	70.4032	738.55	24077.3	0	0
19	72.6028	735.508	27044	0	0
20	74.8024	732.496	30254.6	0	0
21	77.002	729.513	33700	0	0
22	79.2016	726.558	37371.2	0	0
23	81.4012	723.63	41259.1	0	0
24	83.6008	720.729	45355.2	0	0
25	85.8004	717.856	49651	0	0
26	88	715.008	53615.2	0	0

List Of Coordinates

Distributed Load

X	Y
88	780.5
88	763.102
88	715

 BYER GEOTECHNICAL INC.	<i>Project</i> BG 21898 HARVARD WESTLAKE SECTION 6		
	<i>Analysis Description</i> CALCULATE THE MINIMUM REQUIRED EFP TO REPRESENT SOIL NAIL EARTH BLOCK		
	<i>Drawn By</i> R. ZWEIGLER	<i>Scale</i>	<i>Company</i> BYER GEOTECHNICAL, INC.
	<i>Date</i> 5/18/15	<i>File Name</i> 21898 Section 6 efp on back of soil nail wall.slim	

External Boundary

X	Y
88	715
88	763.102
88	780.5
71	785
55	790
38	795
0	800
0	780
0	630
210	630
210	715
122	715

Material Boundary

X	Y
0	780
88	763.102

 BYER GEOTECHNICAL INC.	<i>Project</i> BG 21898 HARVARD WESTLAKE SECTION 6		
	<i>Analysis Description</i> CALCULATE THE MINIMUM REQUIRED EFP TO REPRESENT SOIL NAIL EARTH BLOCK		
	<i>Drawn By</i> R. ZWEIGLER	<i>Scale</i>	<i>Company</i> BYER GEOTECHNICAL, INC.
	<i>Date</i> 5/18/15		<i>File Name</i> 21898 Section 6 efp on back of soil nail wall.slim

0.29

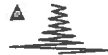

BG 21898 HARVARD WESTLAKE SECTION 6

CALCULATE THE MINIMUM REQUIRED EFP APPLIED TO THE FACE OF THE PROPOSED SOIL NAIL CONFIGURATION TO ACHIEVE A FACTOR OF SAFETY OF 1.0 UNDER SEISMIC LOADING.

THE RESULTS INDICATE THAT AN EFP OF 25 PCF WILL ACHIEVE A FACTOR OF SAFETY OF 1.086.

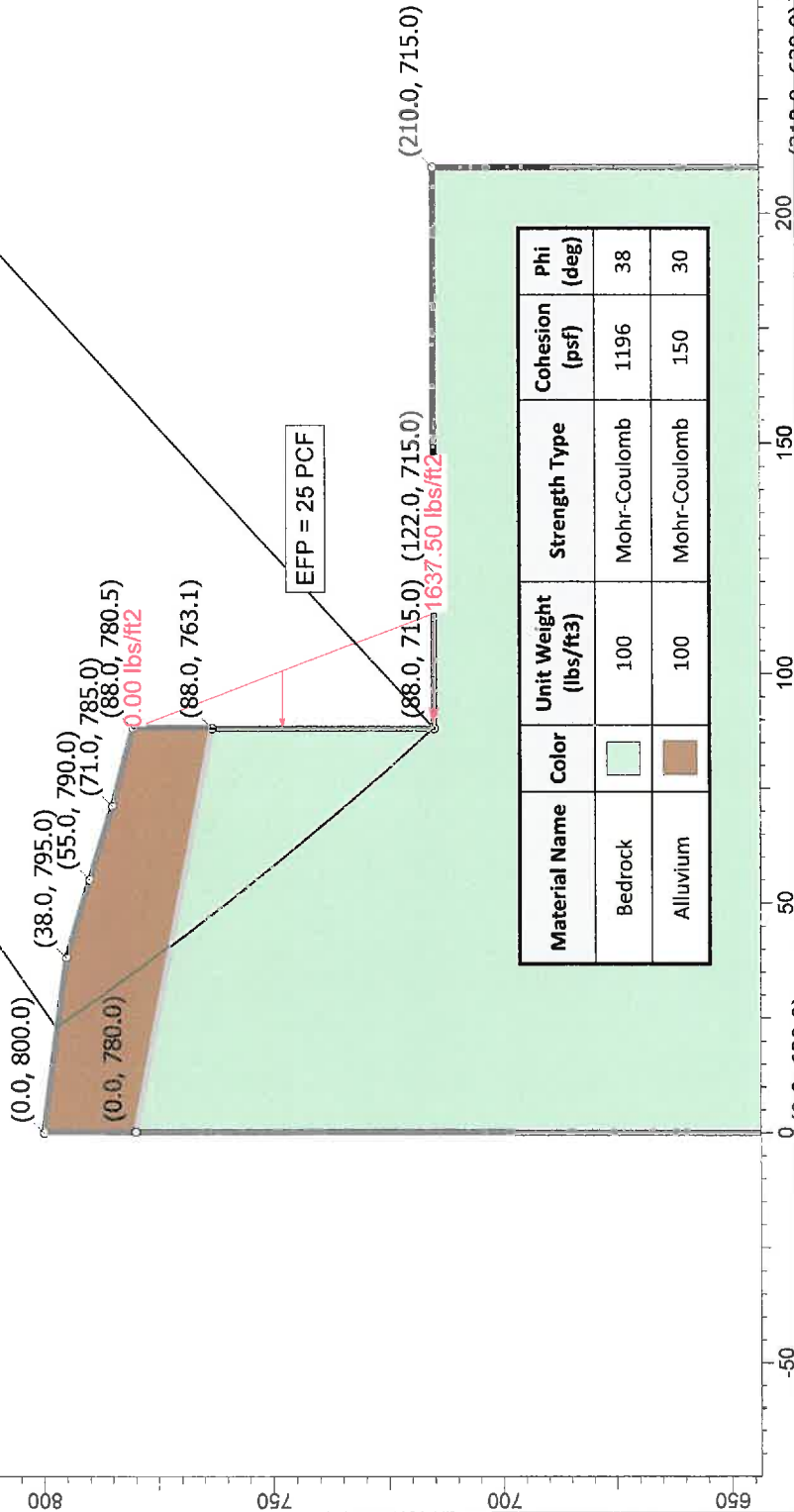

Material Name	Color	Unit Weight (lbs/ft3)	Strength Type	Cohesion (psf)	Phi (deg)
Bedrock		100	Mohr-Coulomb	1196	38
Alluvium		100	Mohr-Coulomb	150	30

Project

BG 21898 HARVARD WESTLAKE SECTION 6

Analysis Description

CALCULATE THE MINIMUM REQUIRED EFP TO REPRESENT SOIL NAIL EARTH BLOCK (SEISMIC)

Drawn By

R. ZWEIGLER

Scale

1:499

Company

BYER GEOTECHNICAL, INC.

Date

5/18/15

File Name 21898 Section 6 efp on back of soil nail wall EQ.slim



BYER
GEOTECHNICAL
INC.

Slide Analysis Information

BG 21898 HARVARD WESTLAKE SECTION 6

Project Summary

File Name: 21898 Section 6 erp on back of soil nail wall EQ
Slide Modeler Version: 6.035
Project Title: BG 21898 HARVARD WESTLAKE SECTION 6
Analysis: CALCULATE THE MINIMUM REQUIRED EFP TO REPRESENT SOIL NAIL EARTH BLOCK (SEISMIC)
Author: R. ZWEIGLER
Company: BYER GEOTECHNICAL, INC.
Date Created: 5/18/15

General Settings

Units of Measurement: Imperial Units
Time Units: days
Permeability Units: feet/second
Failure Direction: Left to Right
Data Output: Standard
Maximum Material Properties: 20
Maximum Support Properties: 20

Analysis Options

Analysis Methods Used

Bishop simplified

Number of slices: 25
Tolerance: 0.005
Maximum number of iterations: 50
Check malpha < 0.2: Yes
Initial trial value of FS: 1
Steffensen Iteration: Yes

Groundwater Analysis

Groundwater Method: Water Surfaces
Pore Fluid Unit Weight: 62.4 lbs/ft³
Advanced Groundwater Method: None

Random Numbers

 BYER GEOTECHNICAL INC. <small>SLIDEINTERPRET 6.035</small>	<i>Project</i> BG 21898 HARVARD WESTLAKE SECTION 6		
	<i>Analysis Description</i> CALCULATE THE MINIMUM REQUIRED EFP TO REPRESENT SOIL NAIL EARTH BLOCK (SEISMIC)		
	<i>Drawn By</i> R. ZWEIGLER	<i>Scale</i>	<i>Company</i> BYER GEOTECHNICAL, INC.
	<i>Date</i> 5/18/15	<i>File Name</i> 21898 Section 6 erp on back of soil nail wall EQ slim	

Surface Options

Surface Type: Circular
 Search Method: Auto Refine Search
 Divisions along slope: 25
 Circles per division: 10
 Number of iterations: 10
 Divisions to use in next iteration: 50%
 Composite Surfaces: Disabled
 Minimum Elevation: Not Defined
 Minimum Depth: Not Defined



Loading

Seismic Load Coefficient (Horizontal): 0.29
 1 Distributed Load present

Distributed Load 1

Distribution: Triangular
 Magnitude 1 [psf]: 0
 Magnitude 2 [psf]: 1637.5
 Orientation: Horizontal

Material Properties

Property	Bedrock	Alluvium
Color		
Strength Type	Mohr-Coulomb	Mohr-Coulomb
Unit Weight [lbs/ft3]	100	100
Cohesion [psf]	1196	150
Friction Angle [deg]	38	30
Water Surface	None	None
Ru Value	0	0

Global Minimums

Method: bishop simplified

FS: 1.086290
 Center: 663.221, 1241.246
 Radius: 779.619

 BYER GEOTECHNICAL INC. SLIDEINTERPRET 6.035	<i>Project</i> BG 21898 HARVARD WESTLAKE SECTION 6		
	<i>Analysis Description</i> CALCULATE THE MINIMUM REQUIRED EFP TO REPRESENT SOIL NAIL EARTH BLOCK (SEISMIC)		
	<i>Drawn By</i> R. ZWEIGLER	<i>Scale</i>	<i>Company</i> BYER GEOTECHNICAL, INC.
	<i>Date</i> 5/18/15	<i>File Name</i> BG 21898 Section 6 erp on back of soil nail wall EQ slim	

Left Slip Surface Endpoint: 22.532, 797.035
 Right Slip Surface Endpoint: 88.000, 715.008
 Left Slope Intercept: 22.532 797.035
 Right Slope Intercept: 88.000 780.500
 Resisting Moment=1.56244e+008 lb-ft
 Driving Moment=1.43832e+008 lb-ft
 Total Slice Area=2320.36 ft2

Valid / Invalid Surfaces

Method: bishop simplified

Number of Valid Surfaces: 7420

Number of Invalid Surfaces: 0

Slice Data

Global Minimum Query (bishop simplified) - Safety Factor: 1.08629

Slice Number	Width [ft]	Weight [lbs]	Base Material	Base Cohesion [psf]	Base Friction Angle [degrees]	Shear Stress [psf]	Shear Strength [psf]	Base Normal Stress [psf]	Pore Pressure [psf]	Effective Normal Stress [psf]
1	2.56127	427.038	Alluvium	150	30	128.714	139.821	-17.6302	0	-17.6302
2	2.56127	1275.43	Alluvium	150	30	229.872	249.708	172.699	0	172.699
3	2.56127	2112.59	Alluvium	150	30	330.719	359.257	362.444	0	362.444
4	2.56127	2938.78	Alluvium	150	30	431.247	468.459	551.587	0	551.587
5	2.56127	3754.27	Alluvium	150	30	531.446	577.304	740.111	0	740.111
6	2.56127	4559.28	Alluvium	150	30	631.308	685.784	928.005	0	928.005
7	2.56127	5304.85	Alluvium	150	30	724.853	787.401	1104.01	0	1104.01
8	2.64106	6180.21	Bedrock	1196	38	1428.69	1551.97	455.621	0	455.621
9	2.64106	6890.53	Bedrock	1196	38	1536.58	1669.17	605.635	0	605.635
10	2.64106	7590.36	Bedrock	1196	38	1644.01	1785.87	755.005	0	755.005
11	2.64106	8279.91	Bedrock	1196	38	1750.98	1902.07	903.727	0	903.727
12	2.64106	8959.4	Bedrock	1196	38	1857.47	2017.75	1051.79	0	1051.79
13	2.64106	9627.46	Bedrock	1196	38	1963.25	2132.66	1198.87	0	1198.87
14	2.64106	10276.3	Bedrock	1196	38	2067.16	2245.53	1343.34	0	1343.34
15	2.64106	10914	Bedrock	1196	38	2170.32	2357.6	1486.78	0	1486.78
16	2.64106	11542.4	Bedrock	1196	38	2272.97	2469.1	1629.5	0	1629.5
17	2.64106	12161.7	Bedrock	1196	38	2375.1	2580.05	1771.5	0	1771.5
18	2.64106	12772.1	Bedrock	1196	38	2476.71	2690.43	1912.78	0	1912.78
19	2.64106	13376.9	Bedrock	1196	38	2578.26	2800.74	2053.98	0	2053.98
20	2.64106	13998	Bedrock	1196	38	2682.99	2914.51	2199.59	0	2199.59
21	2.64106	14615.9	Bedrock	1196	38	2788.02	3028.6	2345.62	0	2345.62
22	2.64106	15225.5	Bedrock	1196	38	2892.55	3142.15	2490.97	0	2490.97
23	2.64106	15827	Bedrock	1196	38	2996.6	3255.18	2635.63	0	2635.63
24	2.64106	16420.5	Bedrock	1196	38	3100.16	3367.67	2779.6	0	2779.6

 BYER GEOTECHNICAL INC.	<i>Project</i> BG 21898 HARVARD WESTLAKE SECTION 6		
	<i>Analysis Description</i> CALCULATE THE MINIMUM REQUIRED EFP TO REPRESENT SOIL NAIL EARTH BLOCK (SEISMIC)		
	<i>Drawn By</i> R. ZWEIGLER	<i>Scale</i>	<i>Company</i> BYER GEOTECHNICAL, INC.
	<i>Date</i> 5/18/15	<i>File Name</i> 21898 Section 6 etp on back of soil nail wall EQ slim	

Interslice Data

Global Minimum Query (bishop simplified) - Safety Factor: 1.08629

Slice Number	X coordinate [ft]	Y coordinate [ft]	Interslice Normal Force [lbs]	Interslice Shear Force [lbs]	Interslice Force Angle [degrees]
1	22.532	797.035	0	0	0
2	25.0932	793.364	-270.288	0	0
3	27.6545	789.736	137.726	0	0
4	30.2158	786.153	1202.98	0	0
5	32.777	782.611	2905.09	0	0
6	35.3383	779.111	5224.35	0	0
7	37.8996	775.651	8141.69	0	0
8	40.4608	772.231	11601.2	0	0
9	43.1019	768.744	11211.8	0	0
10	45.743	765.298	11242.4	0	0
11	48.384	761.891	11677.5	0	0
12	51.0251	758.523	12502.2	0	0
13	53.6662	755.192	13702	0	0
14	56.3072	751.898	15262	0	0
15	58.9483	748.64	17163.3	0	0
16	61.5894	745.418	19391.7	0	0
17	64.2304	742.231	21934.8	0	0
18	66.8715	739.078	24780.1	0	0
19	69.5126	735.958	27915.7	0	0
20	72.1536	732.871	31331.7	0	0
21	74.7947	729.816	35030	0	0
22	77.4357	726.794	39002	0	0
23	80.0768	723.802	43236.8	0	0
24	82.7179	720.841	47723.6	0	0
25	85.3589	717.909	52451.9	0	0
26	88	715.008	53615.2	0	0

List Of Coordinates

Distributed Load

X	Y
88	780.5
88	763.102
88	715

 <p>BYER GEOTECHNICAL INC.</p>	Project			BG 21898 HARVARD WESTLAKE SECTION 6		
	Analysis Description					CALCULATE THE MINIMUM REQUIRED EFP TO REPRESENT SOIL NAIL EARTH BLOCK (SEISMIC)
	Drawn By	R. ZWEIGLER	Scale	Company	BYER GEOTECHNICAL, INC.	
	Date	5/18/15			File Name	21898 Section 6 etp on back of soil nail wall EQ.slm

External Boundary

X	Y
88	715
88	763.102
88	780.5
71	785
55	790
38	795
0	800
0	780
0	630
210	630
210	715
122	715

Material Boundary

X	Y
0	780
88	763.102

 <p>BYER GEOTECHNICAL INC.</p>	<i>Project</i> BG 21898 HARVARD WESTLAKE SECTION 6		
	<i>Analysis Description</i> CALCULATE THE MINIMUM REQUIRED EFP TO REPRESENT SOIL NAIL EARTH BLOCK (SEISMIC)		
	<i>Drawn By</i> R. ZWEIGLER	<i>Scale</i>	<i>Company</i> BYER GEOTECHNICAL, INC.
	<i>Date</i> 5/18/15	<i>File Name</i> BG 21898 Section 6 erp on back of soil nail wall EQ slim	
<small>SLIDEINTERPRET 6.035</small>			

BG 21898 HARVARD-WESTLAKE
SECTION 6

DETERMINE THE LOCATION OF THE
1.5 FACTOR OF SAFETY PLANE BEFORE
ADDING ANY SUPPORT FORCES FROM
THE PROPOSED RETAINING WALL.

THE MINIMUM FS IS > 1.5.

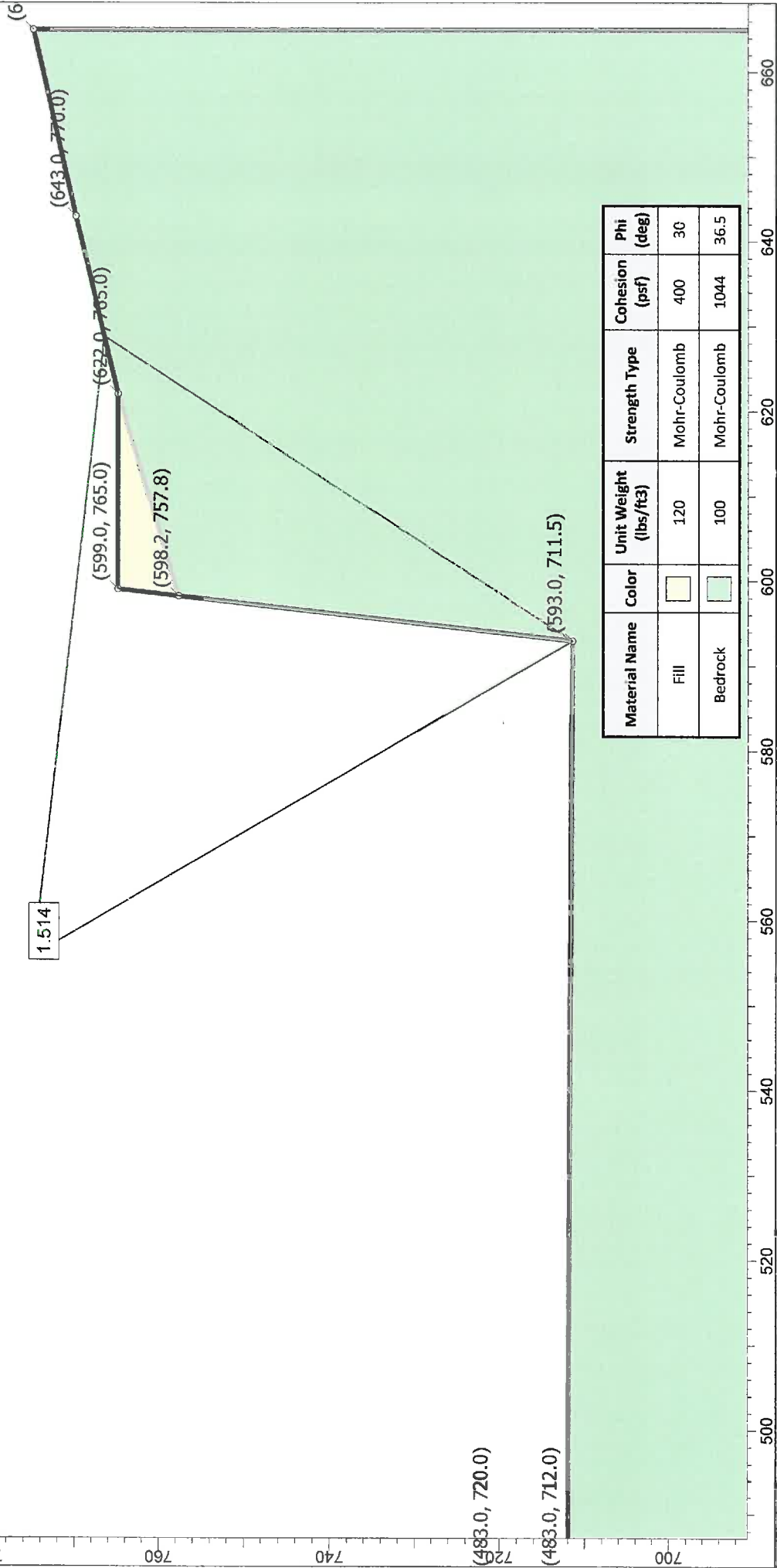

Material Name	Color	Unit Weight (lbs/ft ³)	Strength Type	Cohesion (psf)	Phi (deg)
Fill		120	Mohr-Coulomb	400	30
Bedrock		100	Mohr-Coulomb	1044	36.5

**BYER
GEOTECHNICAL
INC.**

Project: BG 21898 HARVARD WESTLAKE SECTION 7

Analysis Description: CALCULATE THE LOCATION OF THE 1.5 FACTOR OF SAFETY PLANE

Drawn By: R. ZWEIGLER Scale: 1:211 Company: BYER GEOTECHNICAL, INC.

Date: 4/10/15 File Name: 21898 Section 7.slm

Slide Analysis Information

BG 21898 HARVARD WESTLAKE SECTION 7

Project Summary

File Name: 21898 Section 7
Slide Modeler Version: 6.034
Project Title: BG 21898 HARVARD WESTLAKE SECTION 7
Analysis: CALCULATE THE LOCATION OF THE 1.5 FACTOR OF SAFETY PLANE
Author: R. ZWEIGLER
Company: BYER GEOTECHNICAL, INC.
Date Created: 4/10/15

General Settings

Units of Measurement: Imperial Units
Time Units: days
Permeability Units: feet/second
Failure Direction: Right to Left
Data Output: Standard
Maximum Material Properties: 20
Maximum Support Properties: 20

Analysis Options

Analysis Methods Used

Janbu corrected

Number of slices: 25
Tolerance: 0.005
Maximum number of iterations: 50
Check malpha < 0.2: Yes
Initial trial value of FS: 1
Steffensen Iteration: Yes

Groundwater Analysis

Groundwater Method: Water Surfaces
Pore Fluid Unit Weight: 62.4 lbs/ft³
Advanced Groundwater Method: None

 BYER GEOTECHNICAL INC.	<i>Project</i>			BG 21898 HARVARD WESTLAKE SECTION 7	
	<i>Analysis Description</i>			CALCULATE THE LOCATION OF THE 1.5 FACTOR OF SAFETY PLANE	
	<i>Drawn By</i>	R. ZWEIGLER	<i>Scale</i>	<i>Company</i>	BYER GEOTECHNICAL, INC.
	<i>Date</i>	4/10/15		<i>File Name</i>	21898 Section 7.slim

Random Numbers

Pseudo-random Seed: 10116

Random Number Generation Method: Park and Miller v.3

Surface Options

Surface Type: Non-Circular Block Search

Number of Surfaces: 5000

Pseudo-Random Surfaces: Enabled

Convex Surfaces Only: Disabled

Left Projection Angle (Start Angle): 95

Left Projection Angle (End Angle): 265

Right Projection Angle (Start Angle): -85

Right Projection Angle (End Angle): 85

Minimum Elevation: Not Defined

Minimum Depth: Not Defined

Material Properties

Property	Fill	Bedrock
Color	<input type="checkbox"/>	<input type="checkbox"/>
Strength Type	Mohr-Coulomb	Mohr-Coulomb
Unit Weight [lbs/ft ³]	120	100
Cohesion [psf]	400	1044
Friction Angle [deg]	30	36.5
Water Surface	None	None
Ru Value	0	0

Global Minimums

Method: janbu corrected

FS: 1.513720

Axis Location: 555.783, 774.869

Left Slip Surface Endpoint: 593.000, 711.500

Right Slip Surface Endpoint: 628.808, 766.621

Resisting Horizontal Force=54780.3 lb

Driving Horizontal Force=36189.1 lb

Total Slice Area=773.872 ft²

Global Minimum Coordinates

 BYER GEOTECHNICAL INC.	<i>Project</i> BG 21898 HARVARD WESTLAKE SECTION 7		
	<i>Analysis Description</i> CALCULATE THE LOCATION OF THE 1.5 FACTOR OF SAFETY PLANE		
	<i>Drawn By</i> R. ZWEIGLER	<i>Scale</i>	<i>Company</i> BYER GEOTECHNICAL, INC.
	<i>Date</i> 4/10/15	<i>File Name</i> 21898 Section 7.slim	

Method: janbu corrected

X	Y
593	711.5
628.808	766.621

Valid / Invalid Surfaces

Method: janbu corrected

Number of Valid Surfaces: 2271
 Number of Invalid Surfaces: 2729

Error Codes:

- Error Code -105 reported for 108 surfaces
- Error Code -108 reported for 2278 surfaces
- Error Code -112 reported for 1 surface
- Error Code -1000 reported for 342 surfaces

Error Codes

The following errors were encountered during the computation:

- 105 = More than two surface / slope intersections with no valid slip surface.
- 108 = Total driving moment or total driving force < 0.1. This is to limit the calculation of extremely high safety factors if the driving force is very small (0.1 is an arbitrary number).
- 112 = The coefficient M-Alpha = $\cos(\alpha)(1+\tan(\alpha)\tan(\phi)/F) < 0.2$ for the final iteration of the safety factor calculation. This screens out some slip surfaces which may not be valid in the context of the analysis, in particular, deep seated slip surfaces with many high negative base angle slices in the passive zone.
- 1000 = No valid slip surfaces are generated at a grid center. Unable to draw a surface.

Slice Data

Global Minimum Query (janbu corrected) - Safety Factor: 1.51372

Slice Number	Width [ft]	Weight [lbs]	Base Material	Base Cohesion [psf]	Base Friction Angle [degrees]	Shear Stress [psf]	Shear Strength [psf]	Base Normal Stress [psf]	Pore Pressure [psf]	Effective Normal Stress [psf]
1	1.43234	756.766	Bedrock	1044	36.5	541.671	819.938	-302.802	0	-302.802
2	1.43234	2270.3	Bedrock	1044	36.5	836.828	1266.72	300.993	0	300.993
3	1.43234	3783.83	Bedrock	1044	36.5	1131.98	1713.51	904.788	0	904.788
4	1.43234	5321.99	Bedrock	1044	36.5	1431.94	2167.56	1518.41	0	1518.41
5	1.43234	6397.58	Bedrock	1044	36.5	1641.7	2485.07	1947.49	0	1947.49
6	1.43234	6108.58	Bedrock	1044	36.5	1585.34	2399.76	1832.2	0	1832.2

 BYER GEOTECHNICAL INC.	Project		BG 21898 HARVARD WESTLAKE SECTION 7		
	Analysis Description				CALCULATE THE LOCATION OF THE 1.5 FACTOR OF SAFETY PLANE
	Drawn By	R. ZWEIGLER	Scale	Company	BYER GEOTECHNICAL, INC.
	Date	4/10/15	File Name	21898 Section 7.slim	

7	1.43234	5780.39	Bedrock	1044	36.5	1521.34	2302.88	1701.28	0	1701.28
8	1.43234	5452.21	Bedrock	1044	36.5	1457.34	2206	1570.36	0	1570.36
9	1.43234	5124.02	Bedrock	1044	36.5	1393.34	2109.12	1439.43	0	1439.43
10	1.43234	4795.84	Bedrock	1044	36.5	1329.34	2012.25	1308.51	0	1308.51
11	1.43234	4467.66	Bedrock	1044	36.5	1265.34	1915.37	1177.59	0	1177.59
12	1.43234	4139.47	Bedrock	1044	36.5	1201.34	1818.49	1046.66	0	1046.66
13	1.43234	3811.29	Bedrock	1044	36.5	1137.34	1721.61	915.742	0	915.742
14	1.43234	3483.1	Bedrock	1044	36.5	1073.34	1624.73	784.818	0	784.818
15	1.43234	3154.92	Bedrock	1044	36.5	1009.34	1527.86	653.895	0	653.895
16	1.43234	2826.73	Bedrock	1044	36.5	945.339	1430.98	522.971	0	522.971
17	1.43234	2498.55	Bedrock	1044	36.5	881.339	1334.1	392.048	0	392.048
18	1.43234	2170.36	Bedrock	1044	36.5	817.339	1237.22	261.126	0	261.126
19	1.43234	1842.18	Bedrock	1044	36.5	753.339	1140.34	130.202	0	130.202
20	1.43234	1513.99	Bedrock	1044	36.5	689.339	1043.47	-0.72042	0	-0.72042
21	1.43234	1203.19	Bedrock	1044	36.5	628.728	951.718	-124.711	0	-124.711
22	1.43234	934.363	Bedrock	1044	36.5	576.305	872.364	-231.953	0	-231.953
23	1.43234	667.402	Bedrock	1044	36.5	524.244	793.559	-338.452	0	-338.452
24	1.43234	400.441	Bedrock	1044	36.5	472.184	714.754	-444.949	0	-444.949
25	1.43234	133.48	Bedrock	1044	36.5	420.123	635.949	-551.451	0	-551.451

Interslice Data

Global Minimum Query (janbu corrected) - Safety Factor: 1.51372

Slice Number	X coordinate [ft]	Y coordinate - Bottom [ft]	Interslice Normal Force [lbs]	Interslice Shear Force [lbs]	Interslice Force Angle [degrees]
1	593	711.5	0	0	0
2	594.432	713.705	1441.01	0	0
3	595.865	715.91	1972.15	0	0
4	597.297	718.115	1593.44	0	0
5	598.729	720.319	290.07	0	0
6	600.162	722.524	-1659.89	0	0
7	601.594	724.729	-3436.13	0	0
8	603.026	726.934	-5015.07	0	0
9	604.459	729.139	-6396.73	0	0
10	605.891	731.344	-7581.09	0	0
11	607.323	733.548	-8568.17	0	0
12	608.756	735.753	-9357.97	0	0
13	610.188	737.958	-9950.47	0	0
14	611.62	740.163	-10345.7	0	0
15	613.053	742.368	-10543.6	0	0
16	614.485	744.573	-10544.3	0	0

 BYER GEOTECHNICAL INC.	Project			
	BG 21898 HARVARD WESTLAKE SECTION 7			
	Analysis Description			
	CALCULATE THE LOCATION OF THE 1.5 FACTOR OF SAFETY PLANE			
Drawn By		R. ZWEIGLER	Scale	Company
				BYER GEOTECHNICAL, INC.
Date			File Name	
4/10/15			21898 Section 7.slim	

17	615.917	746.777	-10347.6	0	0
18	617.35	748.982	-9953.67	0	0
19	618.782	751.187	-9362.45	0	0
20	620.214	753.392	-8573.94	0	0
21	621.647	755.597	-7588.14	0	0
22	623.079	757.802	-6415.49	0	0
23	624.511	760.007	-5081.25	0	0
24	625.944	762.211	-3586.52	0	0
25	627.376	764.416	-1931.31	0	0
26	628.808	766.621	0	0	0

List Of Coordinates

External Boundary

X	Y
440	650
665	650
665	775
643	770
622	765
599	765
598.195	757.82
593	711.5
483	712
483	720
440	720

Material Boundary

X	Y
598.195	757.82
622	765

	<i>Project</i> BG 21898 HARVARD WESTLAKE SECTION 7				
	<i>Analysis Description</i> CALCULATE THE LOCATION OF THE 1.5 FACTOR OF SAFETY PLANE				
	<i>Drawn By</i> R. ZWEIGLER		<i>Scale</i>	<i>Company</i> BYER GEOTECHNICAL, INC.	
	<i>Date</i> 4/10/15			<i>File Name</i> 21898 Section 7.slim	

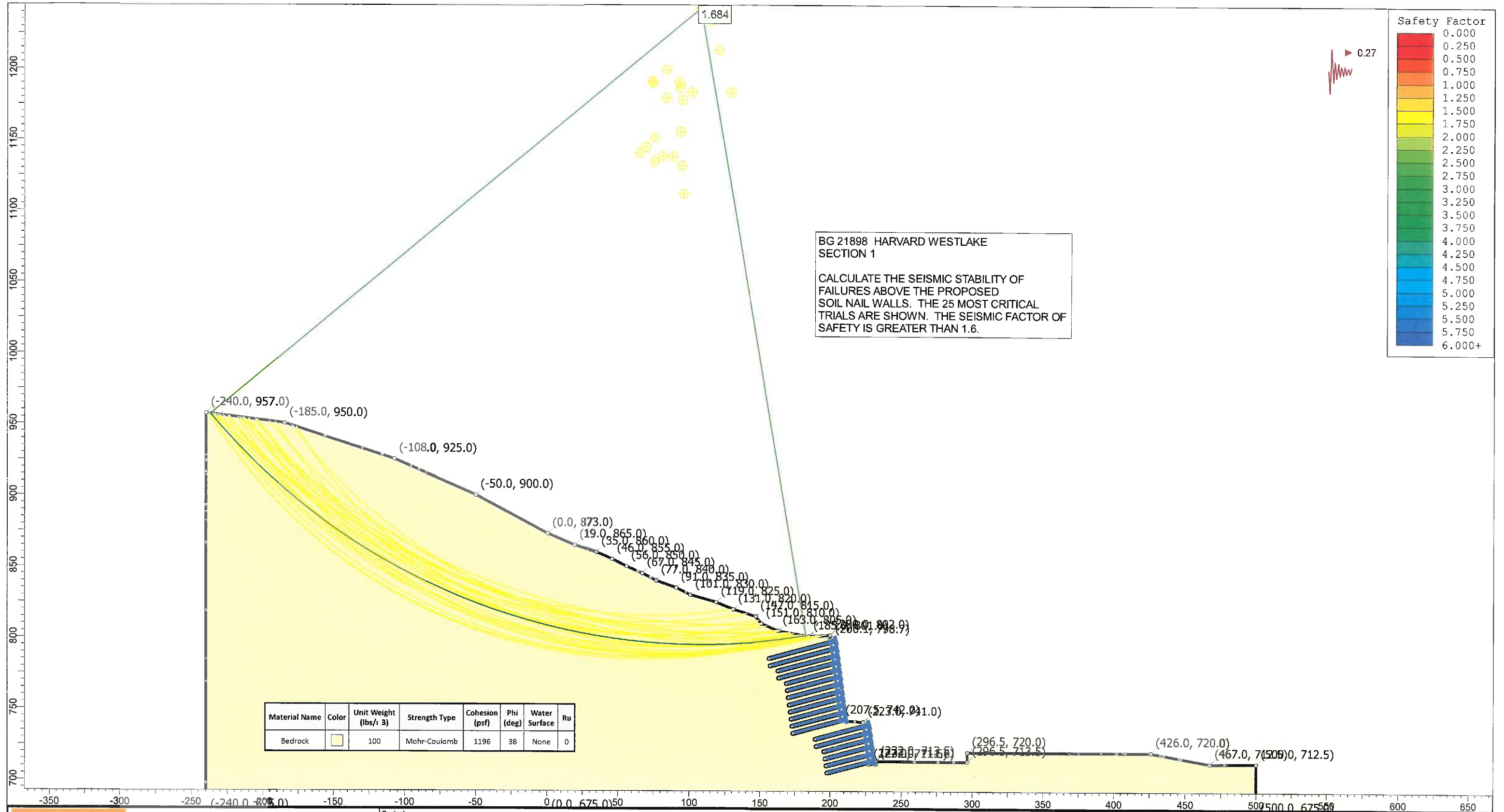

BG 21898 HARVARD WESTLAKE SECTION 1

CALCULATE THE SEISMIC STABILITY OF FAILURES ABOVE THE PROPOSED SOIL NAIL WALLS. THE 25 MOST CRITICAL TRIALS ARE SHOWN. THE SEISMIC FACTOR OF SAFETY IS GREATER THAN 1.6.

	Project			BG 21898 HARVARD-WESTLAKE SECTION 1		
	Analysis Description			CALCULATE THE SEISMIC STABILITY ABOVE THE SOIL NAIL WALLS		
	Drawn By	R. ZWEIGLER	Scale	1:762	Company	BYER GEOTECHNICAL, INC.
	Date	2/12/15	File Name	21898 Section 1 above soil nails EQ.slim		

Slide Analysis Information

BG 21898 HARVARD-WESTLAKE SECTION 1

Project Summary

File Name: 21898 Section 1 above soil nails
Slide Modeler Version: 6.033
Project Title: BG 21898 HARVARD-WESTLAKE SECTION 1
Analysis: CALCULATE THE GROSS STABILITY ABOVE THE SOIL NAIL WALLS
Author: R. ZWEIGLER
Company: BYER GEOTECHNICAL, INC.
Date Created: 2/12/15

General Settings

Units of Measurement: Imperial Units
Time Units: days
Permeability Units: feet/second
Failure Direction: Left to Right
Data Output: Standard
Maximum Material Properties: 20
Maximum Support Properties: 20

Analysis Options

Analysis Methods Used

Bishop simplified

Number of slices: 25
Tolerance: 0.005
Maximum number of iterations: 50
Check $m\alpha < 0.2$: Yes
Initial trial value of FS: 1
Steffensen Iteration: Yes

Groundwater Analysis

Groundwater Method: Water Surfaces
Pore Fluid Unit Weight: 62.4 lbs/ft³
Advanced Groundwater Method: None

 BYER GEOTECHNICAL INC.	<i>Project</i> BG 21898 HARVARD-WESTLAKE SECTION 1		
	<i>Analysis Description</i> CALCULATE THE GROSS STABILITY ABOVE THE SOIL NAIL WALLS		
	<i>Drawn By</i> R. ZWEIGLER	<i>Scale</i>	<i>Company</i> BYER GEOTECHNICAL, INC.
	<i>Date</i> 2/12/15	<i>File Name</i> 21898 Section 1 above soil nails.slim	

Random Numbers

Pseudo-random Seed: 10116

Random Number Generation Method: Park and Miller v.3

Surface Options

Surface Type: Circular

Search Method: Slope Search

Number of Surfaces: 5000

Upper Angle: Not Defined

Lower Angle: Not Defined

Composite Surfaces: Disabled

Reverse Curvature: Create Tension Crack

Minimum Elevation: Not Defined

Minimum Depth: Not Defined

Material Properties

Property	Bedrock	Fill
Color	<input type="checkbox"/>	<input type="checkbox"/>
Strength Type	Mohr-Coulomb	Mohr-Coulomb
Unit Weight [lbs/ft ³]	100	120
Cohesion [psf]	1044	400
Friction Angle [deg]	36.5	30
Water Surface	None	None
Ru Value	0	0

Support Properties

Soil Nail

Support Type: Soil Nail

Force Application: Passive

Out-of-Plane Spacing: 5 ft

Tensile Capacity: 25000 lb

Plate Capacity: 37100 lb

Default Bond Strength: 1810 lb/ft
and Material Dependent

Bond Strength Dependency:

 BYER GEOTECHNICAL INC.	<i>Project</i> BG 21898 HARVARD-WESTLAKE SECTION 1		
	<i>Analysis Description</i> CALCULATE THE GROSS STABILITY ABOVE THE SOIL NAIL WALLS		
	<i>Drawn By</i> R. ZWEIGLER	<i>Scale</i>	<i>Company</i> BYER GEOTECHNICAL, INC.
	<i>Date</i> 2/12/15	<i>File Name</i> 21898 Section 1 above soil nails.slim	

Material	Bond Strength (lbs/ft)
 Bedrock	1810

Global Minimums

Method: bishop simplified

FS: 2.765320
 Center: 101.547, 1183.871
 Radius: 384.466
 Left Slip Surface Endpoint: -205.598, 952.622
 Right Slip Surface Endpoint: 164.884, 804.657
 Resisting Moment=6.33974e+008 lb-ft
 Driving Moment=2.29259e+008 lb-ft
 Total Slice Area=16920.3 ft²

Valid / Invalid Surfaces

Method: bishop simplified

Number of Valid Surfaces: 4942
 Number of Invalid Surfaces: 58

Error Codes:

Error Code -101 reported for 1 surface
 Error Code -106 reported for 47 surfaces
 Error Code -107 reported for 2 surfaces
 Error Code -112 reported for 8 surfaces

Error Codes

The following errors were encountered during the computation:

- 101 = Only one (or zero) surface / slope intersections.
- 106 = Average slice width is less than 0.0001 * (maximum horizontal extent of soil region). This limitation is imposed to avoid numerical errors which may result from too many slices, or too small a slip region.
- 107 = Total driving moment or total driving force is negative. This will occur if the wrong failure direction is specified, or if high external or anchor loads are applied against the failure direction.
- 112 = The coefficient $M\text{-Alpha} = \cos(\alpha)(1 + \tan(\alpha)\tan(\phi))/F < 0.2$ for the final iteration of the safety factor calculation. This screens out some slip surfaces which may not be valid in the context of the analysis, in particular, deep seated slip surfaces with many high negative base angle slices in the passive zone.

Slice Data

 BYER GEOTECHNICAL INC.	<i>Project</i>			BG 21898 HARVARD-WESTLAKE SECTION 1	
	<i>Analysis Description</i>				CALCULATE THE GROSS STABILITY ABOVE THE SOIL NAIL WALLS
	<i>Drawn By</i>	R. ZWEIGLER	<i>Scale</i>	<i>Company</i>	BYER GEOTECHNICAL, INC.
	<i>Date</i>	2/12/15	<i>File Name</i>	21898 Section 1 above soil nails.slim	

Global Minimum Query (bishop simplified) - Safety Factor: 2.76532

Slice Number	Width [ft]	Weight [lbs]	Base Material	Base Cohesion [psf]	Base Friction Angle [degrees]	Shear Stress [psf]	Shear Strength [psf]	Base Normal Stress [psf]	Pore Pressure [psf]	Effective Normal Stress [psf]
1	14.8193	12288.4	Bedrock	1044	36.5	449.505	1243.02	268.966	0	268.966
2	14.8193	34503	Bedrock	1044	36.5	772.254	2135.53	1475.12	0	1475.12
3	14.8193	50680.3	Bedrock	1044	36.5	1022.39	2827.23	2409.9	0	2409.9
4	14.8193	64153.7	Bedrock	1044	36.5	1240.91	3431.51	3226.54	0	3226.54
5	14.8193	75585.5	Bedrock	1044	36.5	1434.52	3966.9	3950.08	0	3950.08
6	14.8193	85223.9	Bedrock	1044	36.5	1604.96	4438.23	4587.03	0	4587.03
7	14.8193	93058.9	Bedrock	1044	36.5	1750.59	4840.94	5131.27	0	5131.27
8	14.8193	97705.8	Bedrock	1044	36.5	1848.55	5111.84	5497.37	0	5497.37
9	14.8193	100618	Bedrock	1044	36.5	1919.79	5308.84	5763.59	0	5763.59
10	14.8193	102292	Bedrock	1044	36.5	1971.33	5451.37	5956.21	0	5956.21
11	14.8193	102509	Bedrock	1044	36.5	1999.03	5527.96	6059.72	0	6059.72
12	14.8193	99838.6	Bedrock	1044	36.5	1978.77	5471.93	5984.01	0	5984.01
13	14.8193	95830.6	Bedrock	1044	36.5	1934.79	5350.3	5819.63	0	5819.63
14	14.8193	90849.5	Bedrock	1044	36.5	1872.62	5178.4	5587.32	0	5587.32
15	14.8193	86505.9	Bedrock	1044	36.5	1819.18	5030.61	5387.59	0	5387.59
16	14.8193	83082.3	Bedrock	1044	36.5	1779.76	4921.61	5240.29	0	5240.29
17	14.8193	79350.5	Bedrock	1044	36.5	1733.73	4794.32	5068.26	0	5068.26
18	14.8193	72183.5	Bedrock	1044	36.5	1626.38	4497.45	4667.07	0	4667.07
19	14.8193	64128.1	Bedrock	1044	36.5	1500.88	4150.4	4198.07	0	4198.07
20	14.8193	56048.6	Bedrock	1044	36.5	1372.21	3794.59	3717.21	0	3717.21
21	14.8193	47524.9	Bedrock	1044	36.5	1232.8	3409.08	3196.23	0	3196.23
22	14.8193	40019.9	Bedrock	1044	36.5	1109.02	3066.79	2733.64	0	2733.64
23	14.8193	31128.6	Bedrock	1044	36.5	957.166	2646.87	2166.16	0	2166.16
24	14.8193	21309.4	Bedrock	1044	36.5	784.9	2170.5	1522.38	0	1522.38
25	14.8193	5612.49	Bedrock	1044	36.5	498.492	1378.49	452.037	0	452.037

Interslice Data

Global Minimum Query (bishop simplified) - Safety Factor: 2.76532

Slice Number	X coordinate [ft]	Y coordinate - Bottom [ft]	Interslice Normal Force [lbs]	Interslice Shear Force [lbs]	Interslice Force Angle [degrees]
1	-205.598	952.622	0	0	0
2	-190.778	934.151	-1693.37	0	0
3	-175.959	917.78	11012.1	0	0
4	-161.14	903.14	31141.2	0	0
5	-146.321	889.973	55235.3	0	0
6	-131.501	878.089	80921.2	0	0

	Project		BG 21898 HARVARD-WESTLAKE SECTION 1	
	Analysis Description		CALCULATE THE GROSS STABILITY ABOVE THE SOIL NAIL WALLS	
	Drawn By	R. ZWEIGLER	Scale	Company
	Date	2/12/15	File Name	21898 Section 1 above soil nails.slim
		BYER GEOTECHNICAL, INC.		

7	-116.682	867.342	106431	0	0
8	-101.863	857.622	130370	0	0
9	-87.0435	848.837	151268	0	0
10	-72.2243	840.916	168468	0	0
11	-57.405	833.802	181632	0	0
12	-42.5857	827.444	190532	0	0
13	-27.7665	821.804	194958	0	0
14	-12.9472	816.849	195126	0	0
15	1.87203	812.55	191393	0	0
16	16.6913	808.886	184175	0	0
17	31.5105	805.838	173775	0	0
18	46.3298	803.39	160485	0	0
19	61.1491	801.533	145052	0	0
20	75.9683	800.256	128169	0	0
21	90.7876	799.555	110441	0	0
22	105.607	799.426	92584.9	0	0
23	120.426	799.868	74940.9	0	0
24	135.245	800.884	58556	0	0
25	150.065	802.478	44497.8	0	0
26	164.884	804.657	0	0	0

List Of Coordinates

External Boundary

X	Y
223	741
207.5	742
200.137	798.701
200	802
185	801
163	805
151	810
147	815
131	820
119	825
101	830
91	835
77	840
67	845
56	850
46	855

	Project BG 21898 HARVARD-WESTLAKE SECTION 1		
	Analysis Description CALCULATE THE GROSS STABILITY ABOVE THE SOIL NAIL WALLS		
	Drawn By R. ZWEIGLER	Scale	Company BYER GEOTECHNICAL, INC.
	Date 2/12/15		File Name 21898 Section 1 above soil nails.slim

35	860
19	865
0	873
-50	900
-108	925
-185	950
-240	957
-240	675
0	675
500	675
500	712.5
467	712.5
426	720
296.5	720
296.5	713.5
232	713.5
232	711.582
227.049	711.582

Material Boundary

X	Y
185	801
200.137	798.701

 <p>BYER GEOTECHNICAL INC.</p>	<i>Project</i>			BG 21898 HARVARD-WESTLAKE SECTION 1	
	<i>Analysis Description</i>				CALCULATE THE GROSS STABILITY ABOVE THE SOIL NAIL WALLS
	<i>Drawn By</i>	R. ZWEIGLER	<i>Scale</i>	<i>Company</i>	BYER GEOTECHNICAL, INC.
	<i>Date</i>	2/12/15		<i>File Name</i>	21898 Section 1 above soil nails.slim



BYER GEOTECHNICAL INC.

1461 E. CHEVY CHASE DR., SUITE 200
GLENDALE, CA 91206
818.549.9959 TEL
818.543.3747 FAX

REGIONAL GEOLOGIC MAP #1

BG: 21898 HARVARD-WESTLAKE SCHOOL

CONSULTANT: RIZ

SCALE: 1" = 1000'

REFERENCE: DIBBLEE, T.W. (1991), GEOLOGIC MAP OF THE BEVERLY HILLS AND VAN NUYS (SOUTH 1/2) QUADRANGLES, LOS ANGELES, CALIFORNIA
DIBBLEE GEOLOGICAL FOUNDATION, MAP DF-31

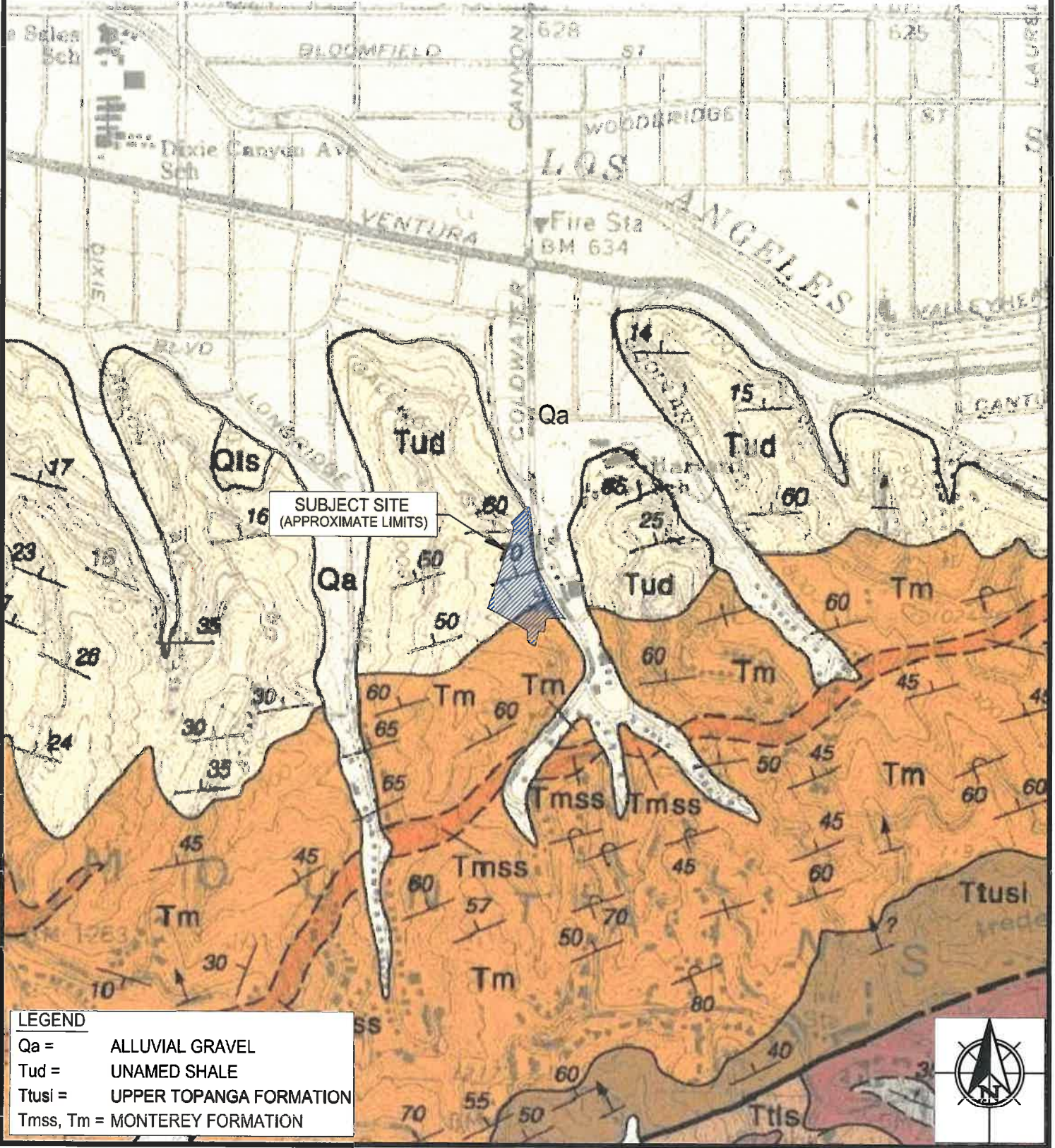

LEGEND	
Qa =	ALLUVIAL GRAVEL
Tud =	UNAMED SHALE
Ttusi =	UPPER TOPANGA FORMATION
Tmss, Tm =	MONTEREY FORMATION





BYER GEOTECHNICAL INC.

1461 E. CHEVY CHASE DR., SUITE 200
GLENDALE, CA 91206
818.549.9959 TEL
818.543.3747 FAX

REGIONAL GEOLOGIC MAP #2

BG: 21898 HARVARD-WESTLAKE SCHOOL

CONSULTANT: RIZ

SCALE: 1" = 1000'

REFERENCE: GEOLOGIC MAP OF THE EASTERN PART OF THE SANTA MONICA MOUNTAINS AND ADJACENT AREAS, LOS ANGELES COUNTY, CALIFORNIA., GEOLOGY BY H.W. HOOTS AND W.S.W. KEW, BASED FROM SURVEY MADE IN 1923-1925.

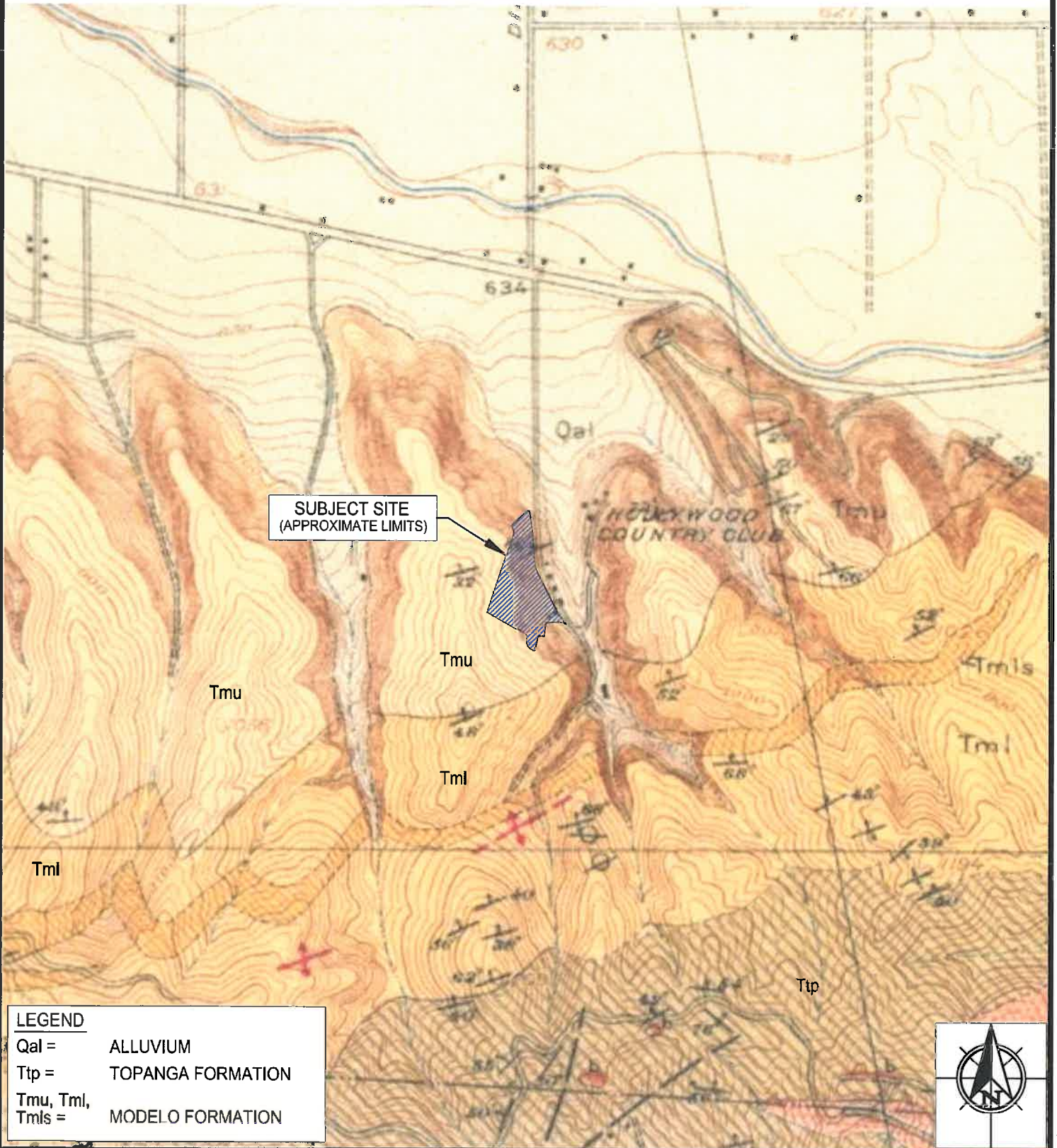

LEGEND	
Qal =	ALLUVIUM
Ttp =	TOPANGA FORMATION
Tmu, Tml,	MODELO FORMATION
Tmls =	



**BYER
GEOTECHNICAL
INC.**

1461 E. CHEVY CHASE DRIVE, #200, GLENDALE, CA 91206
tel 818.549.9959 fax 818.543.3747

REGIONAL FAULT MAP

BG: 21898

CLIENT: HARVARD WESTLAKE
SCHOOL

ENGINEER: RIZ

SCALE: 1 Inch = 12 Miles

Reference: Jennings, C. W., and Bryant, W. A., 2010, Fault Activity Map of California, California Geological Survey, 150th Anniversary, Map No. 6.

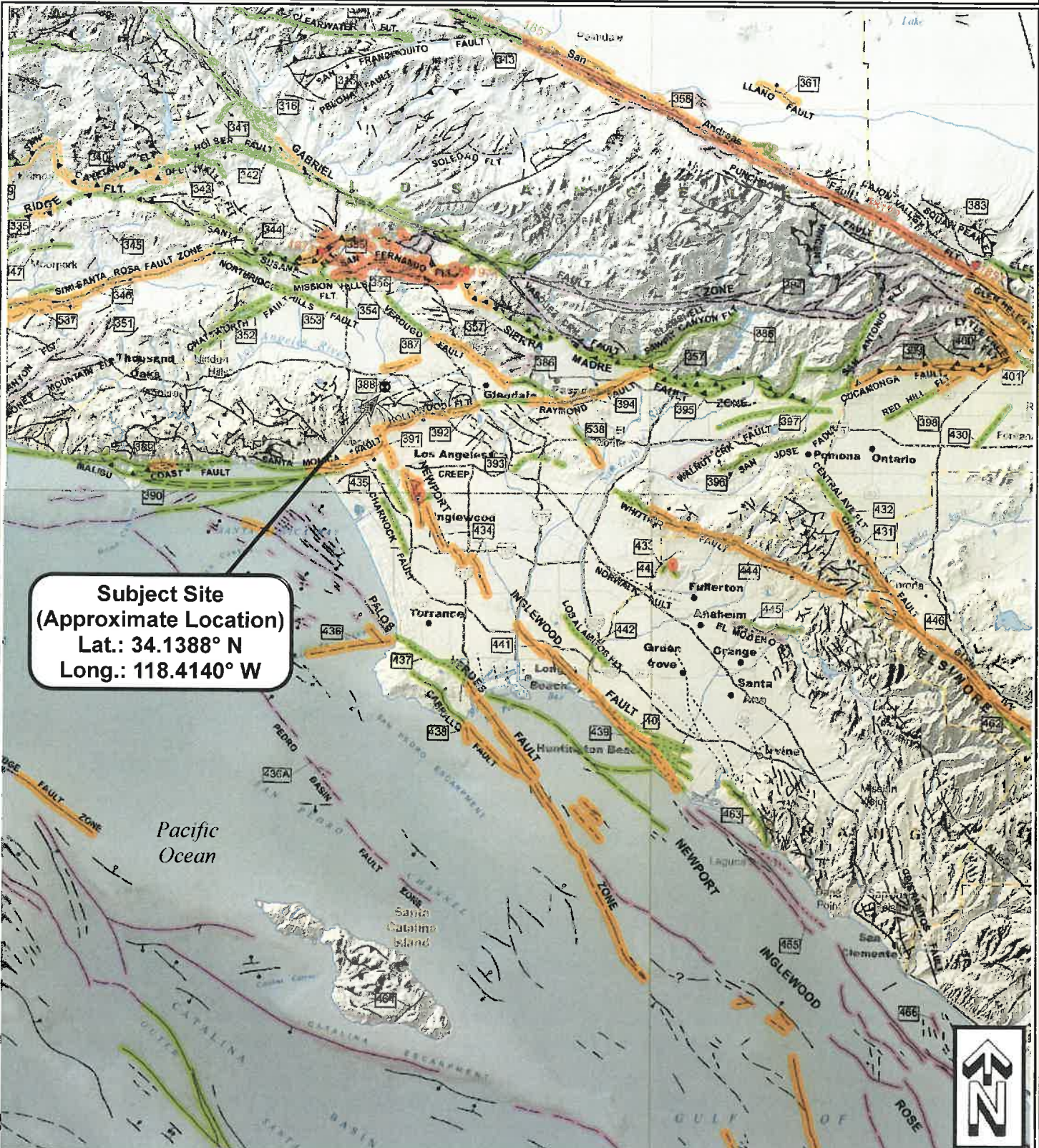



BYER GEOTECHNICAL INC.

1461 E. CHEVY CHASE DR., SUITE 200
GLENDALE, CA 91206
818.549.9959 TEL
818.543.3747 FAX

SEISMIC HAZARD ZONES MAP

BG: 21898 HARVARD-WESTLAKE SCHOOL

CONSULTANT: RIZ

SCALE: 1" = 1000'

REFERENCE: STATE OF CALIFORNIA SEISMIC HAZARD ZONES, VAN NUYS QUADRANGLE OFFICIAL MAP, CALIFORNIA GEOLOGICAL SURVEY, DATED FEBRUARY 1, 1998.

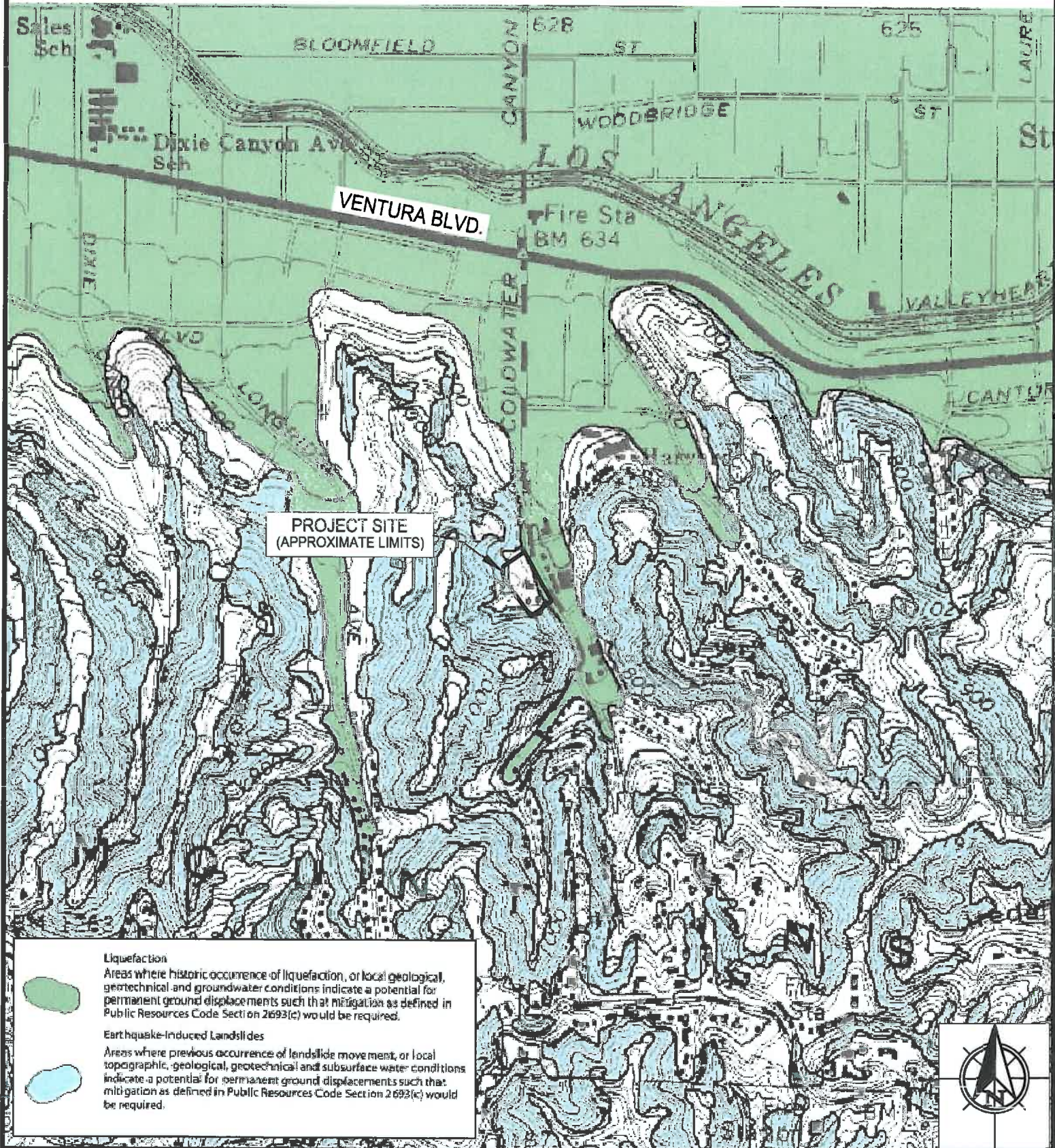



**BYER
GEOTECHNICAL
INC.**
1461 E. CHEVY CHASE DR., SUITE 200
GLENDALE, CA 91206
818.549.9959 TEL
818.543.3747 FAX

ALL EARTHQUAKES FROM 4-24-89 TO 5-1-2015 2.0 & LARGER WITHIN 32 Km RADIUS FROM SITE (1044 EVENTS)	
BG:	21898 HARVARD-WESTLAKE SCHOOL Parking Structure
CONSULTANT:	RIZ/JWB
SCALE:	As Shown (Approximate)

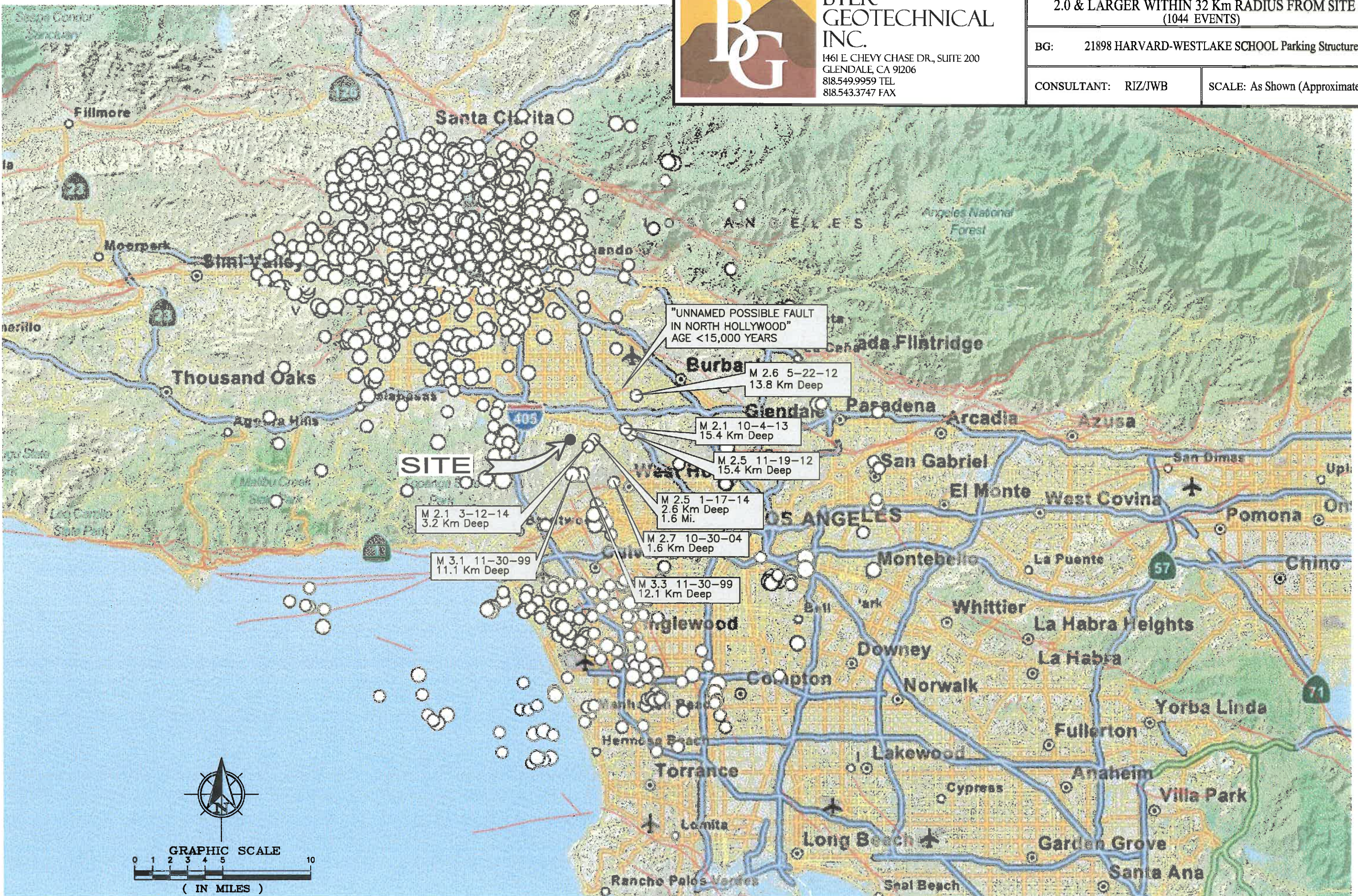

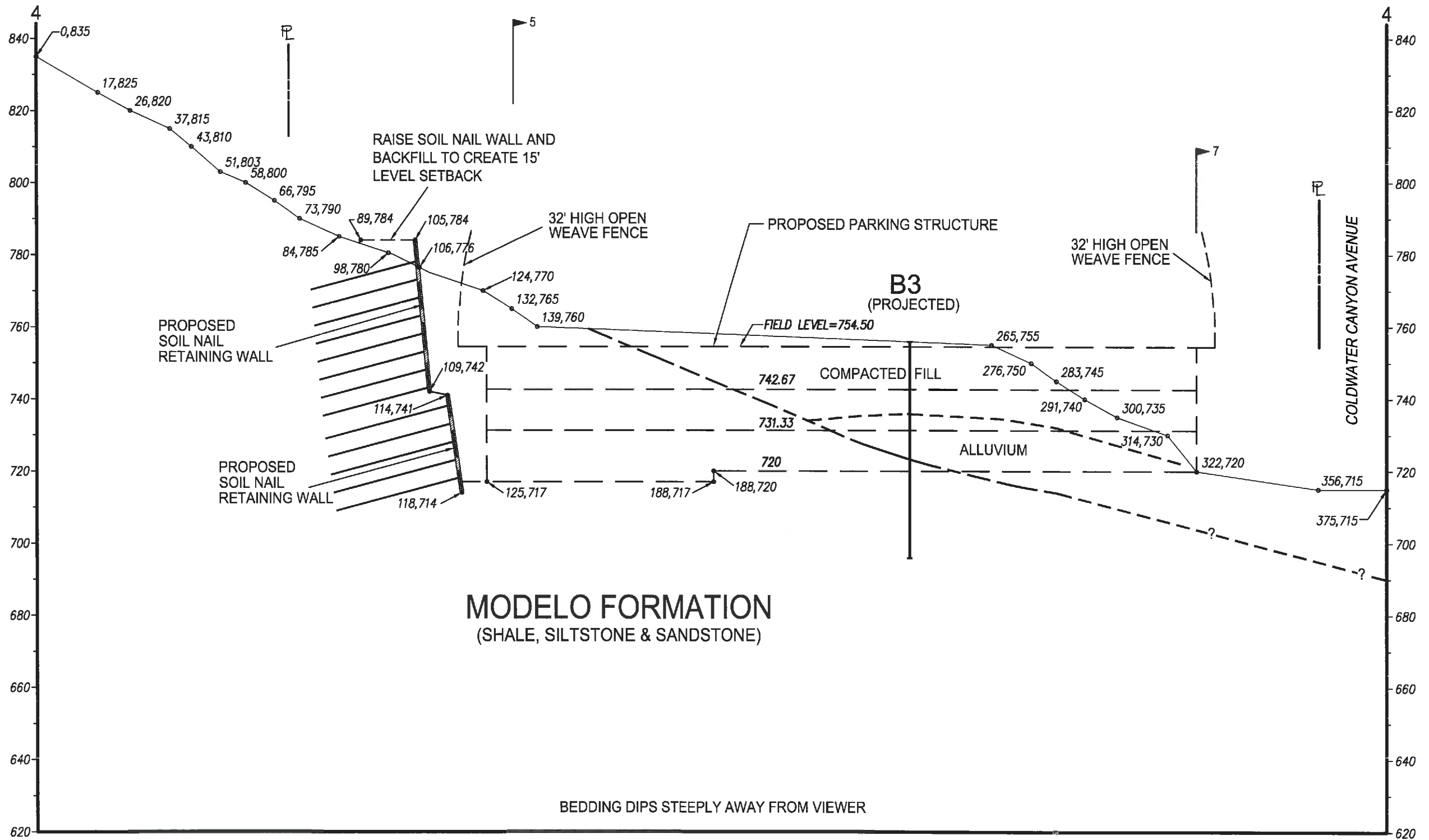

SECTION 4

MAY 18 2015

**BYER
GEOTECHNICAL
INC.**
1461 E. CHEVY CHASE DR., SUITE 200
GLENDALE, CA 91206
818.549.9959 TEL
818.543.3747 FAX

SECTION 4	
BG: 21898 HARVARD-WESTLAKE SCHOOL	
CONSULTANT: RIZ	SCALE: 1" = 30'

REF: DETAIL 2, SHEET A9, PER INNOVATIVE DESIGN GROUP PLANS, DATED 1-17-2013 & SOIL NAIL WALL PLANS PER DRS ENGINEERING, INC. DATED 12-19-14.

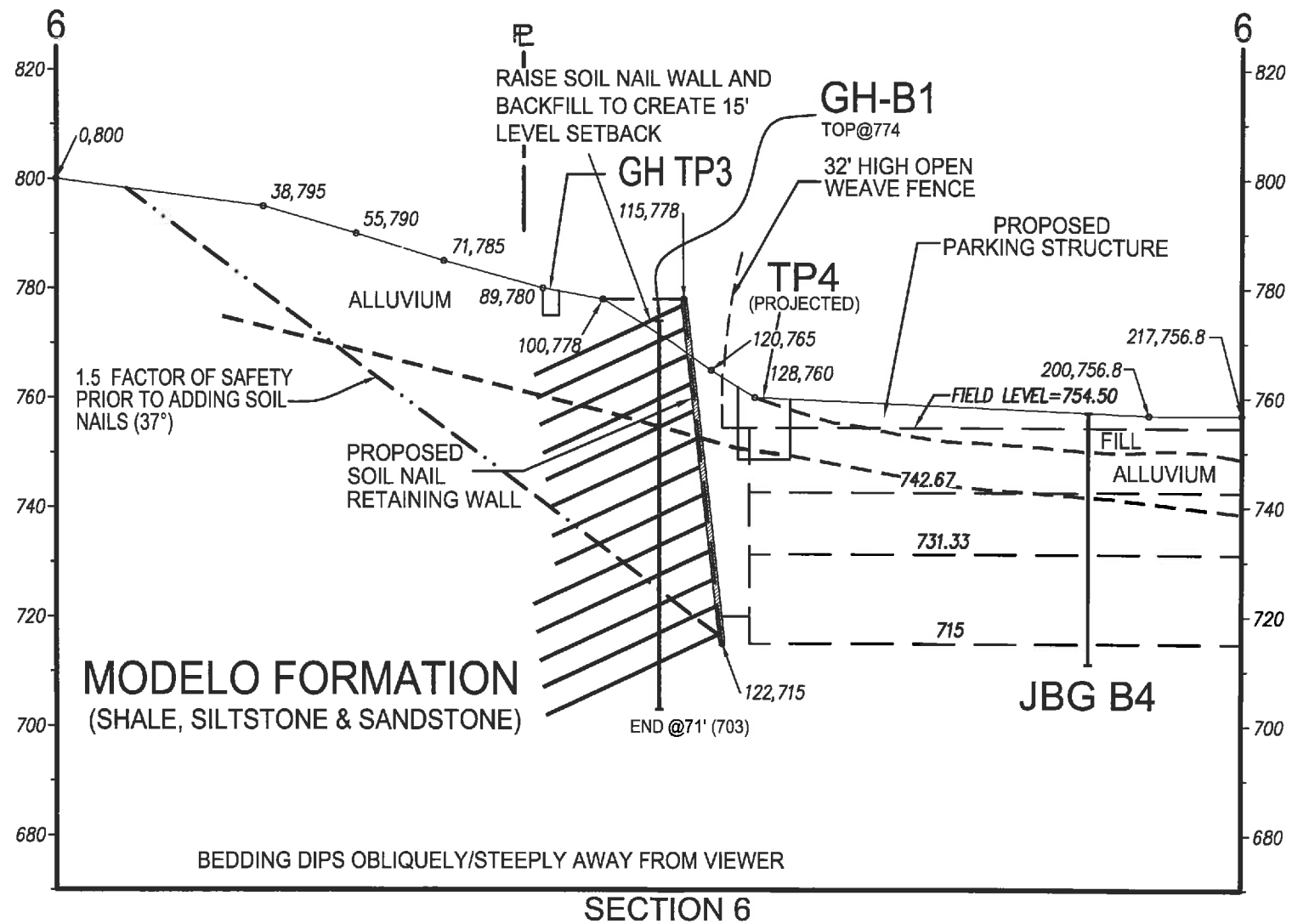

MAY 18 2015

**BYER
GEOTECHNICAL
INC.**
1461 E. CHEVY CHASE DR., SUITE 200
GLENDALE, CA 91206
818.549.9959 TEL
818.543.3747 FAX

SECTION 6	
BG: 21898 HARVARD-WESTLAKE SCHOOL	
CONSULTANT: RIZ	SCALE: 1" = 30'

REF: DETAIL 2, SHEET A9, PER INNOVATIVE DESIGN GROUP PLANS, DATED 1-17-2013 & SOIL NAIL WALL PLANS PER DRS ENGINEERING, INC. DATED 12-19-14.

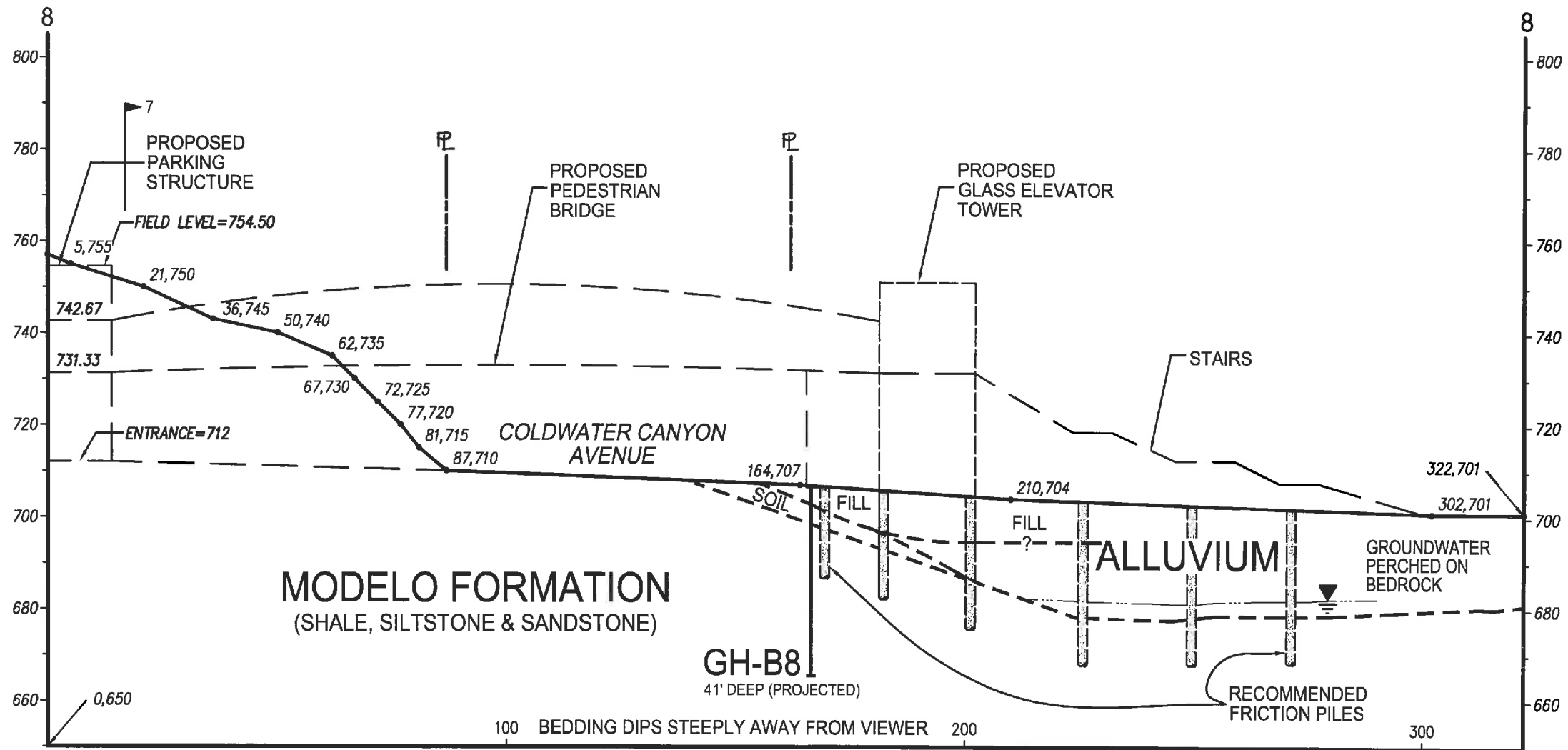

SECTION 8

MAY 18 2015

REF: DETAIL 2, SHEET A9, PER INNOVATIVE DESIGN GROUP PLANS, DATED 1-17-2013 & SOIL NAIL WALL PLANS PER DRS ENGINEERING, INC. DATED 12-19-14.

	<p>BYER GEOTECHNICAL INC.</p>
	<p>1461 E. CHEVY CHASE DR., SUITE 200 GLENDALE, CA 91206 818.549.9959 TEL 818.543.3747 FAX</p>

SECTION 8	
BG: 21898 HARVARD-WESTLAKE SCHOOL	
CONSULTANT: RIZ	SCALE: 1" = 30'

APPENDIX VII

DRS Engineering, Inc.

Preliminary Permanent Soil Nail Wall Design, dated May 18, 2015



Harvard Westlake School

Los Angeles CA

Preliminary Permanent Soil Nail Wall Design

Date: May 18 2015

DRS Engineering Inc. Project No. 2014-04





Contents

Soil Nail Wall - basis of Design	1
Soil Nail Wall - Factors of Safety	3
Soil Nail Wall - Geotechnical and Structural Capacities	4
Permanent Soil Nail Wall - Facing Design	5
Summary of Analysis	9
EFP Check	10
Sliding Block Check	11
Bearing Capacity Check	12
Appendix A SLIDE Analysis	13
Appendix B EFP, Sliding And Bearing Capacity Checks	171



Soil Nail Wall - Basis of Design

Soil walls are designed using the guidelines set forth in the FHWA Geotechnical Engineering Circular No. 7 – SOIL NAIL WALLS - Report No FHWA0-IF-03-017 - March 2003. and the "Recommended Guidelines for Permanent Soil Nails" dated 08/23/2000 by the California Soil Nail Committee.

Soil nail wall design is based upon Allowable Stress Design (ASD) concepts per Chapter 6 of the FHWA manual. The soil nail wall design procedure is as described below:

- * Calculate the ultimate and allowable nail tendon capacities for seismic and static design.
- * Calculate the ultimate and allowable nail head capacities for seismic and static design. .
- * Determine the ultimate and allowable nail tendon pullout resistance for seismic and static design..
- * Define the ultimate soil strengths for static and seismic design.
- * Determine the various design cases for each wall alignment (based upon wall heights, soil conditions, surcharge loading etc.) and from experience, determine a trial soil nail design layout for each design case.
- * Perform global stability analysis utilizing the above parameters to determine the force/moment equilibrium factor of safety (resisting forces/driving forces) for the design cases for static and seismic design .

The global stability analysis is performed using the Slope Stability Program SLIDE v5.044 developed by Rocscience. SLIDE is a comprehensive slope stability analysis software and offers multiple different material strength models for rock and soil. Various limit equilibrium methods of analysis are available. The Bishop Simplified Method with circular surface generation was utilized for isotropi soil conditions. Where planar an-isotropic conditions exist, the Bishop Simplified Method with non-circular surface generation was utilized. The program allows the effects of soil nails to be included in the analysis. Soil nails are modeled using input parameters such as the tensile capacity, plate capacity and bond strength. The bond strength is the shear force per unit length preventing pullout. Customized values of bond strength for different soil units are utilized. At any point along the length of the soil nail, there are 3 failure modes which are considered:

- * Pullout (force required to pull the length past the failure surface out of the slope)
- * Tensile Failure (maximum axial capacity of the soil nail tendon)
- * Stripping (slope failure occurs but the soil nail remains embedded in slope)

The failure mode is determined by which one of the above three produces the least restraining force. This force is then applied to the base of the slip surface at the point of intersection in a direction parallel to the direction of the nail.

Appendix A provides the results of the SLIDE analysis for the soil nail configurations on five (5) critical cross sections (indicated on the soil nailing plan). For each cross section the minimum factor of safety for 4 conditions are presented:

Condition

- | | |
|---|---|
| 1 | Excavated slopes with no soil nail supports |
| 2 | Excavated Slopes with soil nail support (Static Conditions) |
| 3 | Excavated slopes under seismic loading with no soil nails |
| 4 | Excavated slopes under seismic loading with soil nails installed. |



The following file naming convention is used

DRS(x) BG(y) (a,b,c,d) (N, NSN) (ST,EQ)

DRS(x) = DRS Engineering Section (x)
BG (y) = Byer Geotechnical Section (y)
a,b,c,d = No meaning - for file ordering only
N = With Nails installed
NSN = No Soil Nails installed
ST = Static Design
EQ = Seismic Design

i.e. DRS2 BG3 aN ST = DRS Section 2, Byer Section 3, with nails installed, static analysis
DRS4 BG1 cNSN EQ = DRS Section 4, Byer Section 1, no soil nails installed, seismic analysis

Soil Nail Wall - Factors of Safety

Allowable component capacities for input into the SNAIL-Z global stability analysis are determined using the recommended Factor of safety provided in Table 5.3 of FHWA-O-IF-03-017 as follows:

Table 5.3: Minimum Recommended Factors of Safety for the Design of Soil Nail Walls using the ASD Method.

Failure Mode	Resisting Component	Symbol	Minimum Recommended Factors of Safety		
			Static Loads ⁽¹⁾		Seismic Loads ⁽²⁾ (Temporary and Permanent Structures)
			Temporary Structure	Permanent Structure	
External Stability	Global Stability (long-term)	FS _G	1.35	1.5 ⁽¹⁾	1.1
	Global Stability (excavation)	FS _G	1.2-1.3 ⁽²⁾		NA
Internal Stability	Pullout Resistance	FS _P	2.0		1.5
	Nail Bar Tensile Strength	FS _T	1.8		1.35
Facing Strength	Facing Flexure	FS _{FF}	1.35	1.5	1.1
	Facing Punching Shear	FS _{FP}	1.35	1.5	1.1
	H.-Stud Tensile (A307 Bolt)	FS _{HT}		2.0	1.5
					1

- Notes: (1) For non-critical, permanent structures, some agencies may accept a design for static loads and long-term conditions with FS_G = 1.35 when less uncertainty exists due to sufficient geotechnical information and successful local experience on soil nailing.
- (2) The second set of safety factors for global stability corresponds to the case of temporary excavation lifts that are unsupported for up to 48 hours before nails are installed. The larger value may be applied to more critical structures or when more uncertainty exists regarding soil conditions.
- (3) The safety factors for bearing capacity are applicable when using standard bearing-capacity equations. When using stability analysis programs to evaluate these failure modes, the factors of safety for global stability apply.



Engineering

Soil Nail Geotechnical and Structural Capacities

Soil Shear Strength		Static Analysis		Seismic Analysis	
Soil Type Type	Unit Weight pcf	Cohesion psf	ϕ deg	Cohesion psf	ϕ deg
Bedrock (Section 1, 2 - Weak Zone)	115.0	510.0	19.5	700.0	23.0
Bedrock (Section 1, 2 - Other areas)	115.0	540.0	36.0	825.0	37.0
Bedrock (Section 3, 4, 5, 6, 7)	100.0	1044.0	36.5	1196.0	38.0
Fill	120.0	400.0	30.0	400.0	30.0
Alluvium	110.0	150.0	30.0	150.0	30.0

Grout to Ground Bond Stress		Static Analysis		Seismic Analysis	
Soil Type Type	Ultimate Bond psi	Factor of Safety	Allowable Bond psi	Factor of Safety	Allowable Bond psi
Bedrock (All sections)	16.0	2.0	8.0	1.5	10.7
Fill	12.0	2.0	6.0	1.5	8.0
Alluvium	10.0	2.0	5.0	1.5	6.7

Seismic Coefficient

$K_h = 0.27$

Nail Tendon Capacity

Select Soil Nail Tendon Type

Gr 75

Allthread #7 bar:

$A_s = 0.60$

S_{qin}

Soil nail Drill shaft Dia.

6 in

Allthread #8 bar:

$A_s = 0.79$

S_{qin}

Allthread #14 bar:

$A_s = 2.25$

S_{qin}

Factor of Safety on Tendon Capacity

	Temporary	Permanent
Static	1.80	1.80
Seismic	1.35	1.35

Allowable Nail tensile strength(ksi)

	Temporary	Permanent
Static	41.7	41.7
Seismic	55.6	55.6

	Static	Seismic	
Plate Capacity	37,100	37,100 lbs	(See permanent facing design)
Tensile Capacity for #7 bar	25,000	33,333 lbs	(Applies to walls in Section 1, 4, 5, 6, 7)
Tensile Capacity for #8 bar	32,917	43,889 lbs	(Applies to walls in Section 3)
Tensile Capacity for #14 bar	93,750	125,000 lbs	(Applies to walls in Section 2)
Bond Capacity Bedrock 6" hole	1,810	2,413 lbs/ft	
Bond Capacity Bedrock 8" hole	2,413	3,217 lbs/ft	
Bond Capacity Fill	1,357	1,810 lbs/ft	
Bond Capacity Alluvium	1,131	1,508 lbs/ft	

Permanent Soil Nail Wall Facing Design

Maximum Soil Nail Vertical Spacing	$S_V =$	5 ft
Maximum Soil Nail Horizontal Spacing	$S_H =$	5 ft

Permanent Facing Materials

Element	Description	Permanent Facing	
General	Thickness (h)	8.0 in	
	Facing Type	CIP Concrete	
	f'c	4000 psi	
Reinforcement	Type	Rebar or WWF	
	Grade	60 ksi	
	Denomination	#6@16" or WWF4x4W11xW11	
Plate	Dimensions	Size (Square)	8 in
		Thickness (t_p)	1 in
Headed Studs	Dimensions	Length, L_s	6.0 in
		No. of studs, N_H	4.0
		Head Dia., D_H	1.25 in
		Shaft Dia., D_S	0.75 in
		Shaft Area, A_{SH}	0.44 sq.in
		Head Thk., t_s	0.375 in
		Spacing, S_{SH}	6.0 in

Check Limiting Reinforcement Ratios:

$$\rho_{\min} (\%) = 0.24 \cdot \sqrt{f'c \text{ (psi)}} / f_y \text{ (ksi)} = 0.25 \% \quad \text{Eq. 5.51}$$

$$\rho_{\max} (\%) = 0.05 \cdot f'c \text{ (psi)} / f_y \text{ (ksi)} \cdot [90 / (90 + f_y \text{ (ksi)})] = 2.00 \% \quad \text{Eq. 5.53}$$

Consider 1 ft width for analysis. The ratio of reinforcement per unit length:

$$a_{s \text{ MIN}} = \rho_{\min} \cdot d \cdot \text{width} = 0.12 \text{ in}^2 / \text{ft}$$

$$a_{s \text{ MAX}} = \rho_{\max} \cdot d \cdot \text{width} = 0.96 \text{ in}^2 / \text{ft}$$

Select Reinforcement:

Use: #6 @ 16 $a_{vm} = 0.33 \text{ in}^2 / \text{ft}$

Or use WWF 4x4 W11 x W11

Verify Minimum Reinforcement Ratios

$$a_{vn} = 0.33 \text{ in}^2 / \text{ft} > a_{s \text{ MIN}} = 0.12 \text{ in}^2 / \text{ft} \quad \text{OK}$$

Verify Maximum Reinforcement Ratios

$$a_{vm} = 0.33 \text{ in}^2 / \text{ft} < a_{s \text{ MAX}} = 0.96 \text{ in}^2 / \text{ft} \quad \text{OK}$$

Flexural Capacity, R_{FF} :

Select C_f Factor

Table 5.1: Factors C_f .

Type of Structure	Nominal Facing Thickness mm (in.)	Factor C_f
Temporary	100 (4)	2.0
	150 (6)	1.5
	200 (8)	1.0
Permanent	All	1.0

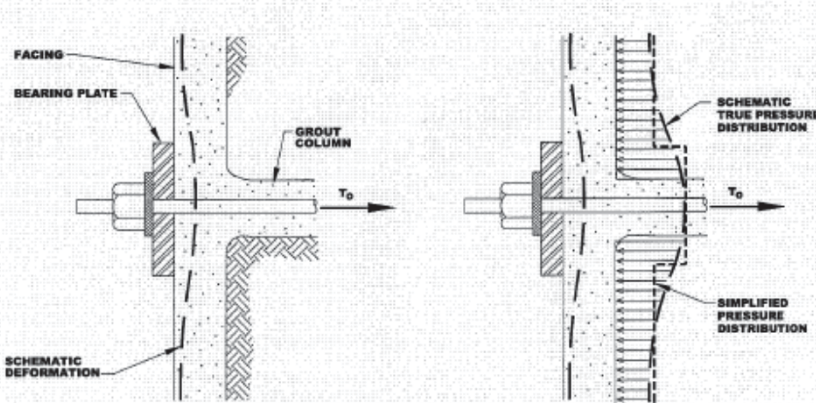

Using Table 5.1, for permanent facing

$$C_f = 1$$

Total Reinforcement Area Per Unit Length Around the Nail:

$$a_{vn} = a_{vm} = 0.33 \text{ in}^2 / \text{ft}$$

$$R_{FF1} = 3.8 * C_f * (a_{vn} + a_{vm}) (\text{in}^2/\text{ft}) * (S_h / S_v) * h (\text{ft}) * f_y (\text{ksi}) = 100.32 \text{ kip} \quad \text{Eq. 5.43a}$$

$$R_{FF2} = 3.8 * C_f * (a_{vn} + a_{vm}) (\text{in}^2/\text{ft}) * (S_v / S_h) * h (\text{ft}) * f_y (\text{ksi}) = 100.32 \text{ kip} \quad \text{Eq. 5.43b}$$

$$\text{Minimum Flexural Capacity} = \text{Min of } (R_{FF1} \text{ and } R_{FF2}) = 100.32 \text{ kip}$$

$$\text{Minimum Factor of Safety on Facing flexure (Static Analysis)} = 1.50$$

$$\text{Minimum Factor of Safety on Facing flexure (Seismic Analysis)} = 1.10$$

$$\text{Minimum Factored Flexural Capacity (Static Analysis) } R_{FF} = 66.9 \text{ kip}$$

$$\text{Minimum Factored Flexural Capacity (Seismic Analysis) } R_{FF} = 91.2 \text{ kip}$$

Punching Shear Capacity, R_{FP} :

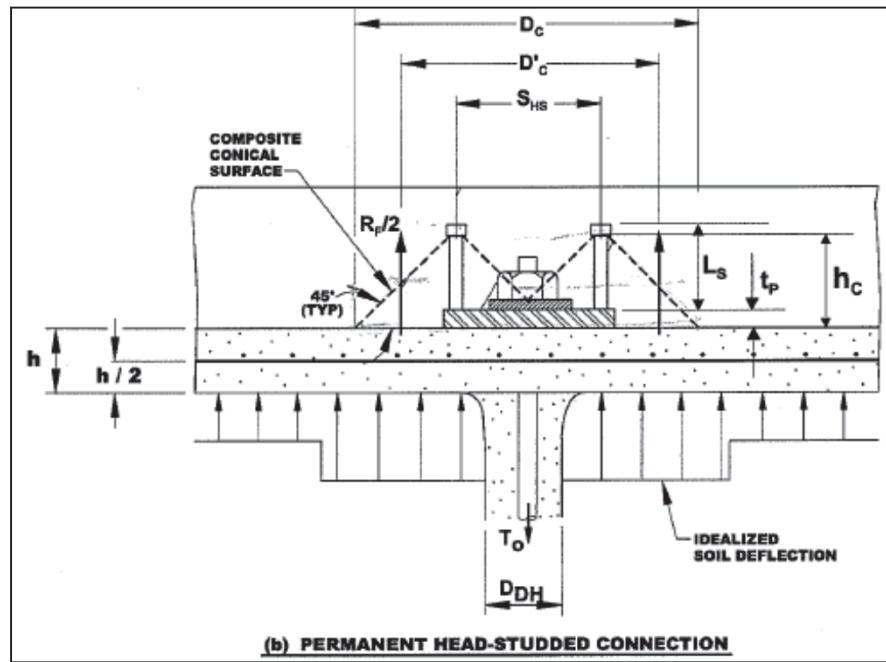

Effective depth of failure cone $h_c = L_s - t_s + t_p = 6.6 \text{ in}$ *Eq. 5.58b*

Failure cone's mean diameter $D'_c = \text{min of } (S_{HS} + h_c \text{ and } 2h_c) = 1.1 \text{ ft}$ *Eq. 5.58a*

$V_f \text{ (kip)} = 0.58 * \text{sqrt}(f'c \text{ (psi)}) * p * D'c \text{ (ft)} * h \text{ (ft)} = 66.9 \text{ kip}$ *Eq. 5.56*

Resistance against punching shear failure $R_{FP} = C_p * V_f$ Where, $C_p = 1$
 $R_{FP} = 66.9 \text{ kip}$

Factor of Safety Required on Punching shear Capacity (Static Analysis) = 1.5

Factor of Safety Required on Punching shear Capacity (Seismic Analysis) = 1.1

Minimum Factored Punching Shear Capacity (Static Analysis) $R_{FP} = 44.6 \text{ kip}$

Minimum Factored Punching Shear Capacity (Seismic Analysis) $R_{FP} = 60.9 \text{ kip}$



Headed-Stud Tensile Resistance, R_{FS}

$R_{FS} = N_H * A_{SH} * f_y =$ $R_{FS} =$ 106.0 kip *Eq. 5.60*

Factor of Safety Required on Stud Tensile Capacity (Static Analysis) = 2.0

Factor of Safety Required on Stud Tensile Capacity (Seismic Analysis) = 1.5

Minimum Factored Tensile Stud Capacity (Static Analysis) $R_{FS} =$ **53.0 kip**

Minimum Factored Tensile Stud Capacity (Seismic Analysis) $R_{FS} =$ **70.7 kip**

Minimum of R_{FF} , R_{FP} and R_{FS} :

Minimum of R_{FF} , R_{FP} and R_{FS} in STATIC stability analysis = 44.6 kip

Minimum of R_{FF} , R_{FP} and R_{FS} in SEISMIC stability analysis = 60.9 kip

CONCLUSION:

Use facing capacity = **37,100 lbs** (Conservative) as input for static analysis
 Use facing capacity = **37,100 lbs** (Conservative) as input for seismic analysis



Summary of Analyses

DRS Section	Byer Section	Static Factor of Safety with nails	Seismic Factor of Safety with nails
1	5	1.500	1.199
2	5	1.528	1.197
2A	-	2.093	1.627
3	3	1.518	1.160
4	1	1.564	1.216
5	6	1.599	1.388
6	7	1.785	1.482
7	7	2.246	1.573

Minimum Static Factor of safety required 1.5
 Minimum Seismic Factor of safety required 1.1



EFPP Check

The stability analysis takes into account the bond capacity of the soil nails beyond all the potential failure surfaces analyzed to determine that the factor of safety on soil nail pull-out beyond the potential failure surface is not critical. However, the City of Los Angeles DEpartment of Building and Safety, Grading Division requires a separate check that the soil nail bond capacity beyond the "active" wedge is greater than the total force (expressed as an equivalent fluid pressure) due to instability of that active wedge.

Byer Geotechnical has provided the active wedge and the equivalent fluid pressure for the critical sections of the project for both static and seismic conditions.

APPENDIX B provides the additional calculations that demonstrate that the factor of safety for soil nail pullout beyond this active wedge is adequate i.e.

Total Bond Capacity of Soil Nails beyond the active wedge
_____ ≥ 1.0

Total resultant for from Equivalent Fluid Pressure

(Note: Equivalent Fluid Pressure provided include for a factor of safety of 1.5 for static analysis and 1.0 for seismic analysis)



Sliding Block Check

Sliding stability analysis considers the ability of the soil nail wall to resist sliding along the base of the retained system in response to lateral earth pressures behind the soil nails. Sliding failure may occur when additional lateral earth pressures, mobilized by the excavation, exceed the sliding resistance along the base.

In the sliding stability check, the soil nail wall system is modeled as a rigid block against which lateral earth forces are applied behind the retained soil. The rigid block here is defined by a horizontal surface through the base of the extends behind the nails, and exits with a vertical surface to the ground surface behind the reinforced zone. The lateral earth forces acting on the vertical face of the rigid block in both static and seismic conditions, as well as the coefficient of friction and the cohesion of the ground along the sliding surface, have been provided by Byer Geotechnical.

It is assumed that the displacements of the soil block along its base are large enough to mobilize the active pressure behind the block.

APPENDIX B provides the additional calculations that demonstrate that the factor of safety for sliding of the reinforced soil mass is adequate i.e.

Total resisting force on the base of the sliding block

≥ 1.0

Total driving forces from the active pressure on the reinforced block

(Note: Equivalent Fluid Pressure provided include for a factor of safety of 1.5 for static analysis and 1.0 for seismic analysis)



Bearing Capacity (from Overturning) Check

Bearing capacity analysis considers the ability of the substrata beneath the soil nail wall to resist the bearing pressures caused by the overtruning moment from the active earth pressure behind the soil nails.

Overturning failure may occur when bearing pressure under the reinforced soil block exceed the bearing capacity of the underlying strata below the base of the wall.

In the bearing capacity analysis, the soil nail wall system is modeled as a rigid block against which lateral earth forces are applied behind the retained soil. The rigid block here is defined by a horizontal surface through the base of the extends behind the nails, and exits with a vertical surface to the ground surface behind the reinforced zone. The lateral earth forces acting on the vertical face of the rigid block in both static and seismic conditions, as well as the coefficient of friction and the bearing capacity of the underlying strata below the base of the wall has been provided by Byer Geotechnical.

APPENDIX B provides the additional calculations that demonstrate that the factor of safety for overturning of the reinforced soil mass is adequate i.e.

Bearing pressure generated by overturning moment

≥ 1.0

Bearing capacity of underlying strata

(Note: Equivalent Fluid Pressure provided include for a factor of safety of 1.5 for static analysis and 1.0 for seismic analysis)



APPENDIX A

SLIDE - Analysis

Slide Analysis Information

Document Name

File Name: DRS1 BG5 bN ST.sli

Project Settings

Project Title: Harvard-Westlake
Failure Direction: Left to Right
Units of Measurement: Imperial Units
Pore Fluid Unit Weight: 62.4 lb/ft³
Groundwater Method: Water Surfaces
Data Output: Standard
Calculate Excess Pore Pressure: Off
Allow Ru with Water Surfaces or Grids: On
Random Numbers: Random Seed
Random Number Seed: 1428970438
Random Number Generation Method: Park and Miller v.3

Analysis Methods

Analysis Methods used:
Bishop simplified

Number of slices: 25
Tolerance: 0.005
Maximum number of iterations: 50

Surface Options

Surface Type: Non-Circular Block Search
Number of Surfaces: 7000
Pseudo-Random Surfaces: Enabled
Convex Surfaces Only: Disabled
Left Projection Angle (Start Angle): 95
Left Projection Angle (End Angle): 265
Right Projection Angle (Start Angle): 85
Right Projection Angle (End Angle): -85
Minimum Elevation: Not Defined
Minimum Depth: Not Defined

Material Properties

Material: Bedrock Static Anisotropic
Strength Type: Anisotropic function
Unit Weight: 115 lb/ft³
Water Surface: None
Ru value: 0

Support Properties

Support: #7 Soil Nail Static
#7 Soil Nail Static

Support Type: Soil Nail
Force Application: Passive
Out-of-Plane Spacing: 5 ft
Tensile Capacity: 25000 lb
Plate Capacity: 37100 lb
Bond Strength: 1810 lb/ft

Global Minimums

Method: bishop simplified

FS: 1.499630

Axis Location: 130.999, 903.282

Left Slip Surface Endpoint: -15.143, 792.669

Right Slip Surface Endpoint: 131.804, 720.000

Resisting Moment=6.33192e+007 lb-ft

Driving Moment=4.22232e+007 lb-ft

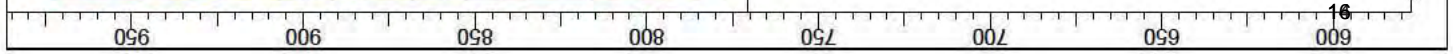
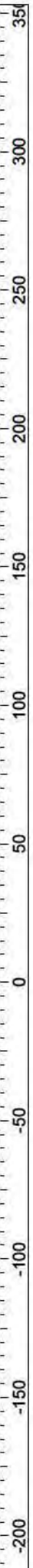
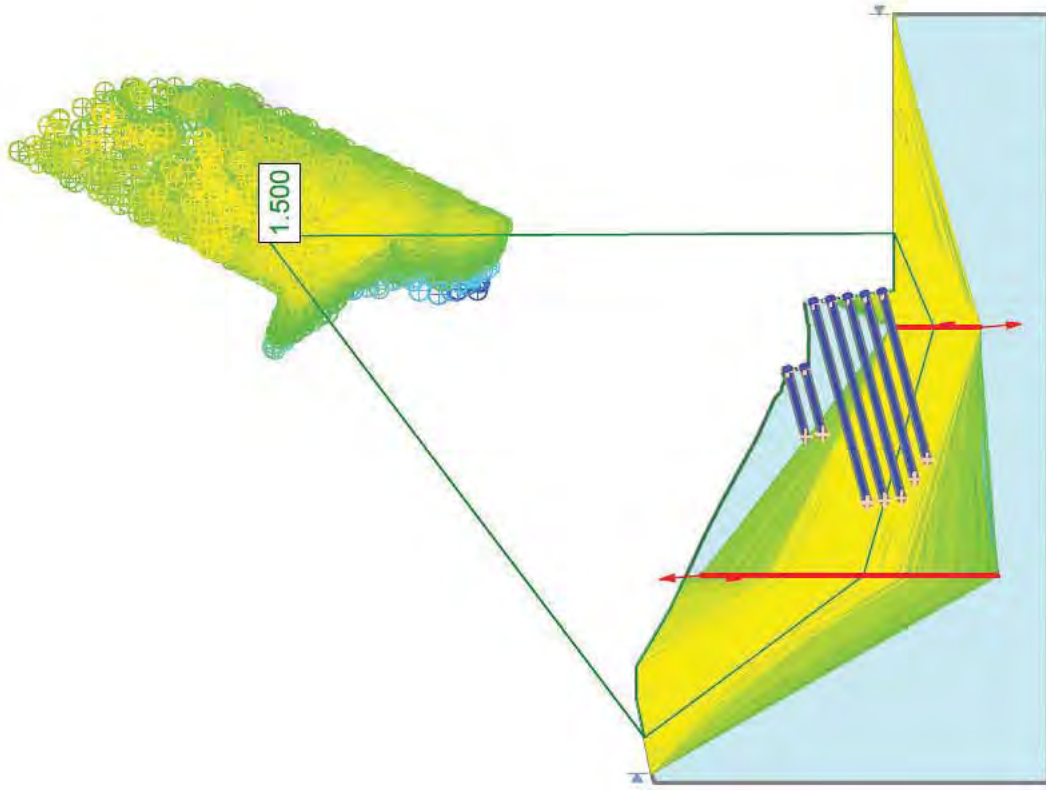
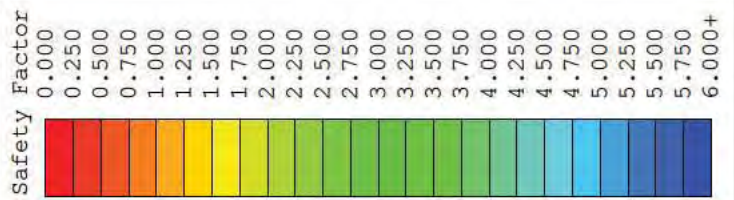

Slide Analysis Information

Document Name

File Name: DRS1 BG5 dN EQ.sli

Project Settings

Project Title: Harvard-Westlake
Failure Direction: Left to Right
Units of Measurement: Imperial Units
Pore Fluid Unit Weight: 62.4 lb/ft³
Groundwater Method: Water Surfaces
Data Output: Standard
Calculate Excess Pore Pressure: Off
Allow Ru with Water Surfaces or Grids: On
Random Numbers: Random Seed
Random Number Seed: 1428970735
Random Number Generation Method: Park and Miller v.3

Analysis Methods

Analysis Methods used:
Bishop simplified

Number of slices: 25
Tolerance: 0.005
Maximum number of iterations: 50

Surface Options

Surface Type: Non-Circular Block Search
Number of Surfaces: 7000
Pseudo-Random Surfaces: Enabled
Convex Surfaces Only: Disabled
Left Projection Angle (Start Angle): 95
Left Projection Angle (End Angle): 265
Right Projection Angle (Start Angle): 85
Right Projection Angle (End Angle): -85
Minimum Elevation: Not Defined
Minimum Depth: Not Defined

Loading

Seismic Load Coefficient (Horizontal): 0.27

Material Properties

Material: Bedrock Seismic Anisotropic
Strength Type: Anisotropic function
Unit Weight: 115 lb/ft³
Water Surface: None
Ru value: 0

Support Properties

Support: #7 Soil Nail Seismic

#7 Soil Nail Seismic

Support Type: Soil Nail

Force Application: Passive

Out-of-Plane Spacing: 5 ft

Tensile Capacity: 33333 lb

Plate Capacity: 37100 lb

Bond Strength: 2413 lb/ft

Global Minimums

Method: bishop simplified

FS: 1.198970

Axis Location: 137.759, 908.148

Left Slip Surface Endpoint: -11.389, 793.432

Right Slip Surface Endpoint: 140.043, 720.000

Resisting Moment=7.21691e+007 lb-ft

Driving Moment=6.01925e+007 lb-ft

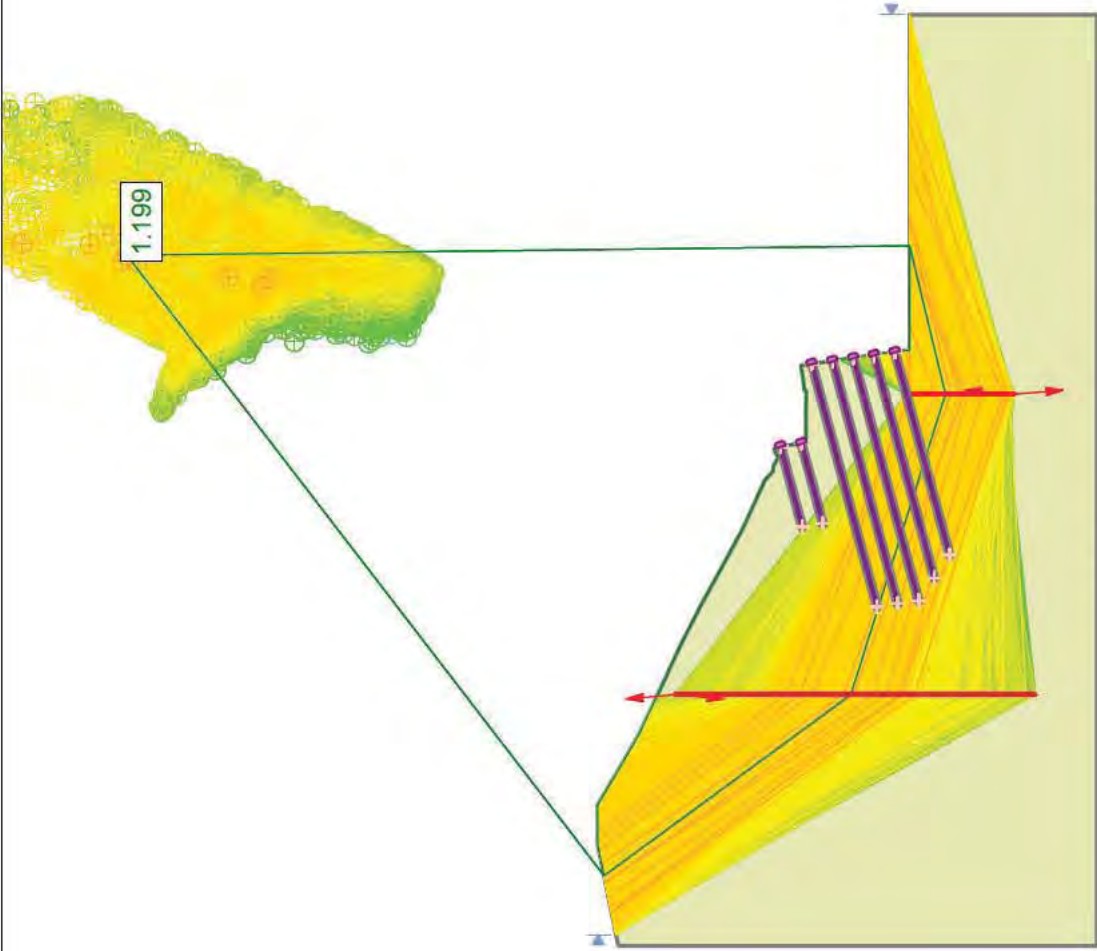
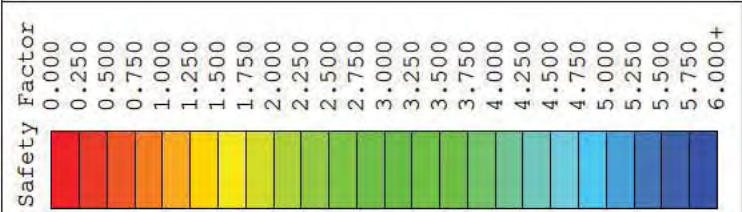

1.199

File Name: DRS1 BG5 dN EQ.sli

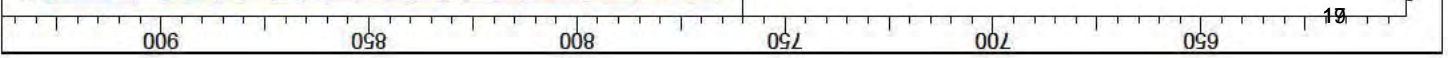
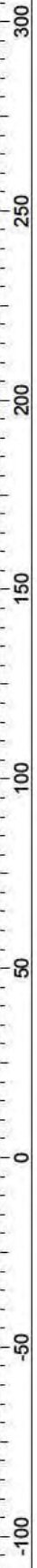

Slide Analysis Information

Document Name

File Name: DRS2 BG5 bN ST.sli

Project Settings

Project Title: Harvard-Westlake
Failure Direction: Left to Right
Units of Measurement: Imperial Units
Pore Fluid Unit Weight: 62.4 lb/ft³
Groundwater Method: Water Surfaces
Data Output: Standard
Calculate Excess Pore Pressure: Off
Allow Ru with Water Surfaces or Grids: On
Random Numbers: Pseudo-random Seed
Random Number Seed: 10116
Random Number Generation Method: Park and Miller v.3

Analysis Methods

Analysis Methods used:
Bishop simplified

Number of slices: 25
Tolerance: 0.005
Maximum number of iterations: 50

Surface Options

Surface Type: Non-Circular Block Search
Number of Surfaces: 5000
Pseudo-Random Surfaces: Enabled
Convex Surfaces Only: Disabled
Left Projection Angle (Start Angle): 95
Left Projection Angle (End Angle): 265
Right Projection Angle (Start Angle): -85
Right Projection Angle (End Angle): 85
Minimum Elevation: Not Defined
Minimum Depth: Not Defined

Material Properties

Material: Bedrock
Strength Type: Anisotropic function
Unit Weight: 115 lb/ft³
Water Surface: None
Ru value: 0

Support Properties

Support: #14 Soil Nail Static
#14 Soil Nail Static

Support Type: Soil Nail
Force Application: Passive
Out-of-Plane Spacing: 4 ft
Tensile Capacity: 93750 lb
Plate Capacity: 37100 lb
Bond Strength: 2413 lb/ft

Global Minimums

Method: bishop simplified

FS: 1.528240

Axis Location: 182.111, 1057.751

Left Slip Surface Endpoint: -75.233, 837.958

Right Slip Surface Endpoint: 203.540, 720.000

Resisting Moment=4.412e+008 lb-ft

Driving Moment=2.88698e+008 lb-ft

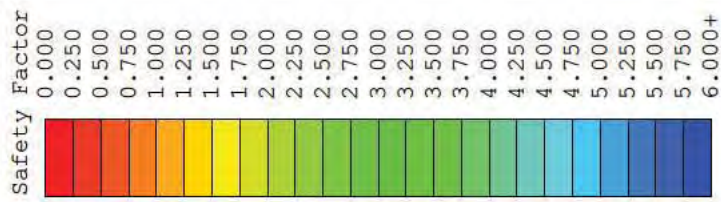
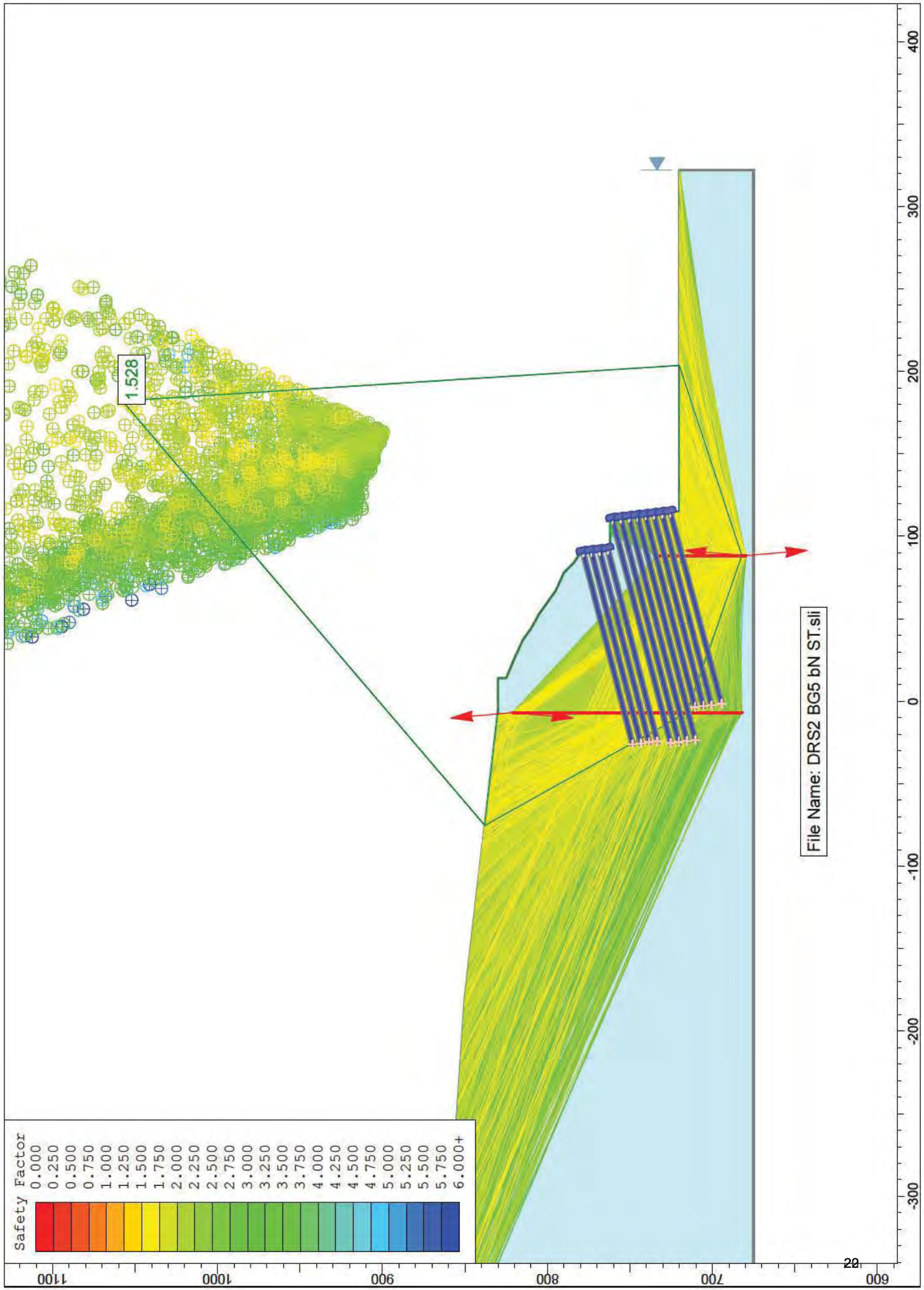

File Name: DRS2 BG5 bN ST.sli

1.528

Slide Analysis Information

Document Name

File Name: DRS2 BG5 dN EQ.sli

Project Settings

Project Title: Harvard-Westlake
Failure Direction: Left to Right
Units of Measurement: Imperial Units
Pore Fluid Unit Weight: 62.4 lb/ft³
Groundwater Method: Water Surfaces
Data Output: Standard
Calculate Excess Pore Pressure: Off
Allow Ru with Water Surfaces or Grids: On
Random Numbers: Pseudo-random Seed
Random Number Seed: 10116
Random Number Generation Method: Park and Miller v.3

Analysis Methods

Analysis Methods used:
Bishop simplified

Number of slices: 25
Tolerance: 0.005
Maximum number of iterations: 50

Surface Options

Surface Type: Non-Circular Block Search
Number of Surfaces: 5000
Pseudo-Random Surfaces: Enabled
Convex Surfaces Only: Disabled
Left Projection Angle (Start Angle): 95
Left Projection Angle (End Angle): 265
Right Projection Angle (Start Angle): -85
Right Projection Angle (End Angle): 85
Minimum Elevation: Not Defined
Minimum Depth: Not Defined

Loading

Seismic Load Coefficient (Horizontal): 0.27

Material Properties

Material: Bedrock Siesmic Anisotropic
Strength Type: Anisotropic function
Unit Weight: 115 lb/ft³
Water Surface: None
Ru value: 0

Support Properties

Support: #14 Soil Nail Seismic

#14 Soil Nail Seismic

Support Type: Soil Nail

Force Application: Passive

Out-of-Plane Spacing: 4 ft

Tensile Capacity: 125000 lb

Plate Capacity: 37100 lb

Bond Strength: 3217 lb/ft

Global Minimums

Method: bishop simplified

FS: 1.197290

Axis Location: 192.086, 1098.245

Left Slip Surface Endpoint: -86.473, 839.250

Right Slip Surface Endpoint: 232.147, 720.000

Resisting Moment=6.20198e+008 lb-ft

Driving Moment=5.18001e+008 lb-ft

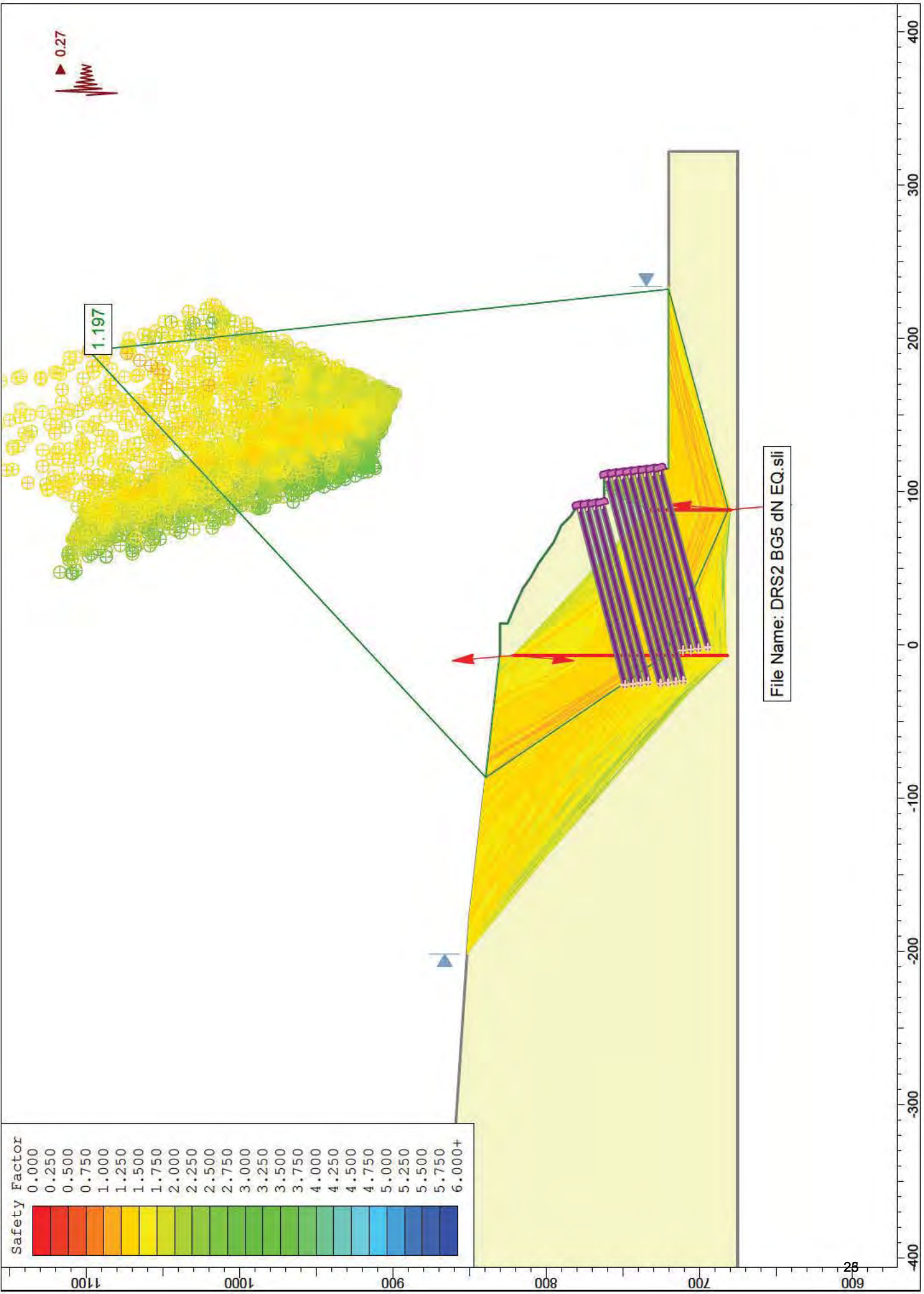
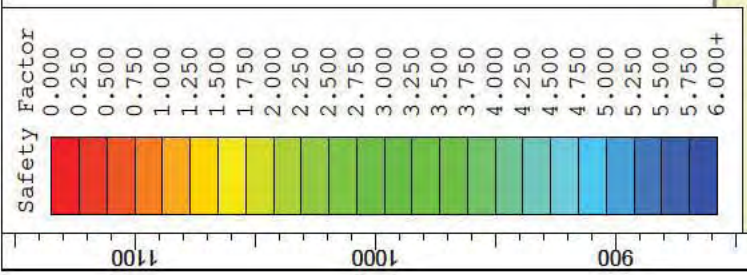

Slide Analysis Information

Document Name

File Name: DRS2A BG5 bN ST

Project Settings

Project Title: Harvard-Westlake
Failure Direction: Left to Right
Units of Measurement: Imperial Units
Pore Fluid Unit Weight: 62.4 lb/ft³
Groundwater Method: Water Surfaces
Data Output: Standard
Calculate Excess Pore Pressure: Off
Allow Ru with Water Surfaces or Grids: On
Random Numbers: Pseudo-random Seed
Random Number Seed: 10116
Random Number Generation Method: Park and Miller v.3

Analysis Methods

Analysis Methods used:
Bishop simplified

Number of slices: 25
Tolerance: 0.005
Maximum number of iterations: 50

Surface Options

Surface Type: Non-Circular Block Search
Number of Surfaces: 5000
Pseudo-Random Surfaces: Enabled
Convex Surfaces Only: Disabled
Left Projection Angle (Start Angle): 95
Left Projection Angle (End Angle): 265
Right Projection Angle (Start Angle): -85
Right Projection Angle (End Angle): 85
Minimum Elevation: Not Defined
Minimum Depth: Not Defined

Material Properties

Material: Bedrock
Strength Type: Mohr-Coulomb
Unit Weight: 115 lb/ft³
Cohesion: 540 psf
Friction Angle: 36 degrees
Water Surface: None
Ru value: 0

Support Properties

Support: #7 Soil Nail Static

#7 Soil Nail Static

Support Type: Soil Nail

Force Application: Passive

Out-of-Plane Spacing: 5 ft

Tensile Capacity: 25000 lb

Plate Capacity: 37100 lb

Bond Strength: 1810 lb/ft

Global Minimums

Method: bishop simplified

FS: 2.092760

Axis Location: 46.934, 938.078

Left Slip Surface Endpoint: -123.003, 842.864

Right Slip Surface Endpoint: 21.144, 745.000

Resisting Moment=5.29902e+007 lb-ft

Driving Moment=2.53207e+007 lb-ft

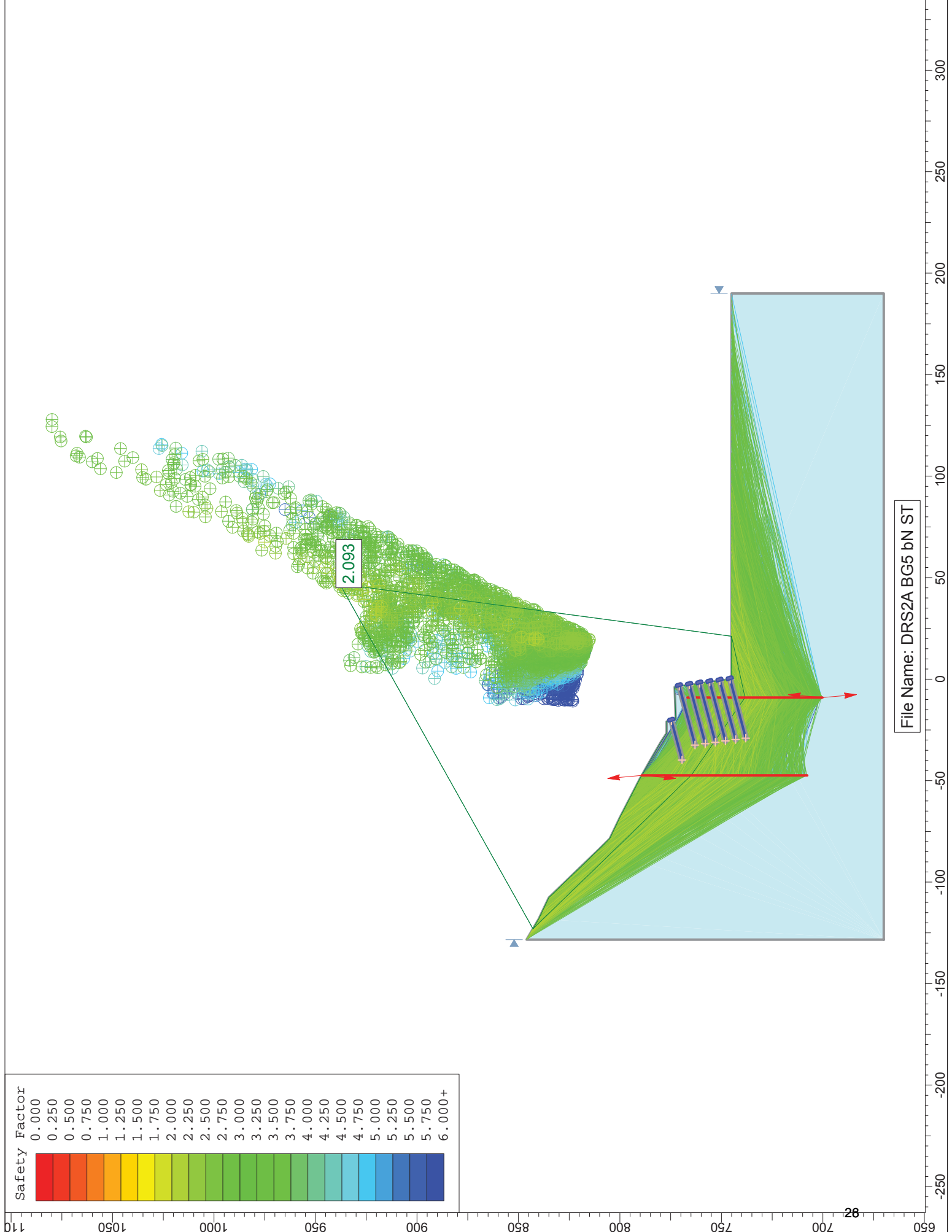

Slide Analysis Information

Document Name

File Name: DRS2A BG5 dN EQ

Project Settings

Project Title: Harvard-Westlake
Failure Direction: Left to Right
Units of Measurement: Imperial Units
Pore Fluid Unit Weight: 62.4 lb/ft³
Groundwater Method: Water Surfaces
Data Output: Standard
Calculate Excess Pore Pressure: Off
Allow Ru with Water Surfaces or Grids: On
Random Numbers: Pseudo-random Seed
Random Number Seed: 10116
Random Number Generation Method: Park and Miller v.3

Analysis Methods

Analysis Methods used:
Bishop simplified

Number of slices: 25
Tolerance: 0.005
Maximum number of iterations: 50

Surface Options

Surface Type: Non-Circular Block Search
Number of Surfaces: 5000
Pseudo-Random Surfaces: Enabled
Convex Surfaces Only: Disabled
Left Projection Angle (Start Angle): 95
Left Projection Angle (End Angle): 265
Right Projection Angle (Start Angle): -85
Right Projection Angle (End Angle): 85
Minimum Elevation: Not Defined
Minimum Depth: Not Defined

Loading

Seismic Load Coefficient (Horizontal): 0.27

Material Properties

Material: Bedrock
Strength Type: Mohr-Coulomb
Unit Weight: 115 lb/ft³
Cohesion: 825 psf
Friction Angle: 37 degrees
Water Surface: None

Ru value: 0

Support Properties

Support: #7 Soil Nail Seismic

#7 Soil Nail Seismic

Support Type: Soil Nail

Force Application: Passive

Out-of-Plane Spacing: 5 ft

Tensile Capacity: 33333 lb

Plate Capacity: 37100 lb

Bond Strength: 2413 lb/ft

Global Minimums

Method: bishop simplified

FS: 1.626700

Axis Location: 35.807, 917.479

Left Slip Surface Endpoint: -123.271, 843.021

Right Slip Surface Endpoint: -0.073, 745.541

Resisting Moment=6.04536e+007 lb-ft

Driving Moment=3.71634e+007 lb-ft

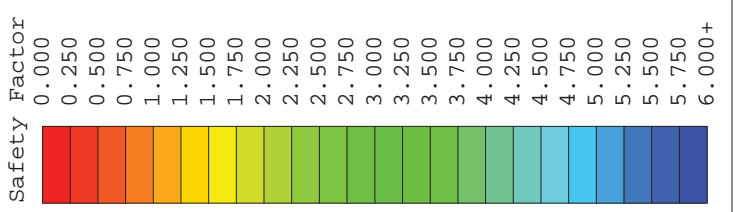
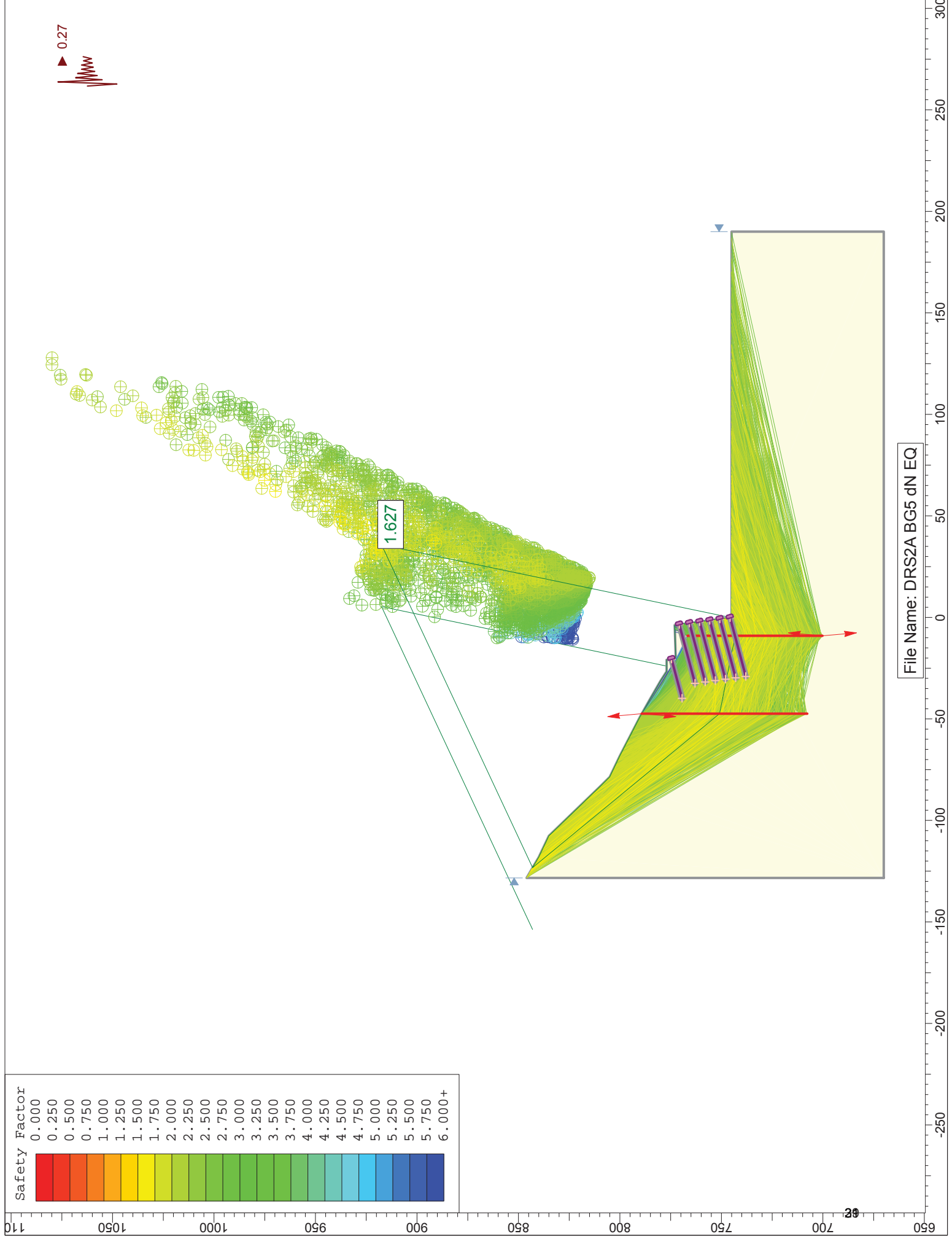

File Name: DRS2A BG5 dN EQ

Slide Analysis Information

Document Name

File Name: DRS3 BG3 dN ST.sli

Project Settings

Project Title: Harvard-Westlake
Failure Direction: Left to Right
Units of Measurement: Imperial Units
Pore Fluid Unit Weight: 62.4 lb/ft³
Groundwater Method: Water Surfaces
Data Output: Standard
Calculate Excess Pore Pressure: Off
Allow Ru with Water Surfaces or Grids: On
Random Numbers: Random Seed
Random Number Seed: 1428973942
Random Number Generation Method: Park and Miller v.3

Analysis Methods

Analysis Methods used:
Bishop simplified

Number of slices: 25
Tolerance: 0.005
Maximum number of iterations: 50

Surface Options

Surface Type: Circular
Search Method: Grid Search
Radius increment: 10
Composite Surfaces: Disabled
Reverse Curvature: Create Tension Crack
Minimum Elevation: Not Defined
Minimum Depth: Not Defined

Loading

3 Distributed Loads present:
Distributed Load #1 Constant Distribution, Orientation: Vertical, Magnitude: 1500 lb/ft²
Distributed Load #2 Triangular Distribution, Orientation: Vertical, Magnitudes 1,2: 1500 and 0 lb/ft²
Distributed Load #3 Triangular Distribution, Orientation: Vertical, Magnitudes 1,2: 1500 and 0 lb/ft²

Material Properties

Material: Bedrock
Strength Type: Mohr-Coulomb
Unit Weight: 100 lb/ft³
Cohesion: 1044 psf

Friction Angle: 36.5 degrees
Water Surface: None
Ru value: 0

Material: Alluvium

Strength Type: Mohr-Coulomb
Unit Weight: 110 lb/ft³
Cohesion: 150 psf
Friction Angle: 30 degrees
Water Surface: None
Ru value: 0

Support Properties

Support: Soil Nail Static

Soil Nail Static
Support Type: Soil Nail
Force Application: Passive
Out-of-Plane Spacing: 5 ft
Tensile Capacity: 32917 lb
Plate Capacity: 37100 lb
Bond Strength: 1131 lb/ft
and Material Dependent

Global Minimums

Method: bishop simplified

FS: 1.517540
Center: 182.273, 826.073
Radius: 119.057
Left Slip Surface Endpoint: 83.677, 759.339
Right Slip Surface Endpoint: 134.382, 717.073
Resisting Moment=1.29558e+007 lb-ft
Driving Moment=8.53733e+006 lb-ft

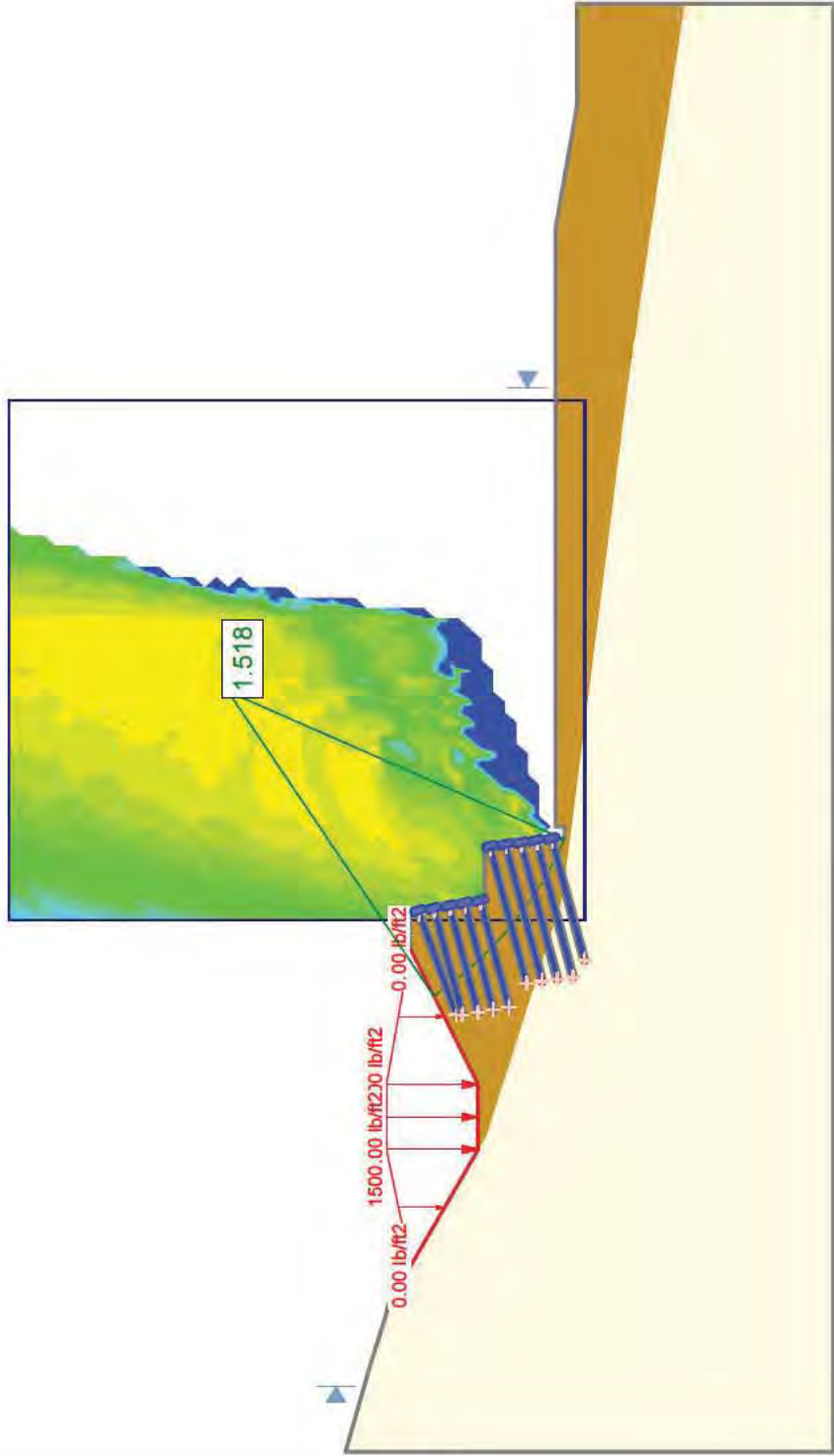
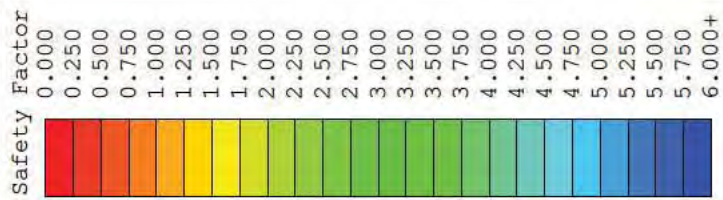

File Name: DRS3 BG3 dN ST.sli



Slide Analysis Information

Document Name

File Name: DRS3 BG3 dN EQ.sli

Project Settings

Project Title: Harvard-Westlake
Failure Direction: Left to Right
Units of Measurement: Imperial Units
Pore Fluid Unit Weight: 62.4 lb/ft³
Groundwater Method: Water Surfaces
Data Output: Standard
Calculate Excess Pore Pressure: Off
Allow Ru with Water Surfaces or Grids: On
Random Numbers: Random Seed
Random Number Seed: 1428973493
Random Number Generation Method: Park and Miller v.3

Analysis Methods

Analysis Methods used:
Bishop simplified

Number of slices: 25
Tolerance: 0.005
Maximum number of iterations: 50

Surface Options

Surface Type: Circular
Search Method: Grid Search
Radius increment: 10
Composite Surfaces: Disabled
Reverse Curvature: Create Tension Crack
Minimum Elevation: Not Defined
Minimum Depth: Not Defined

Loading

Seismic Load Coefficient (Horizontal): 0.27
3 Distributed Loads present:
Distributed Load #1 Constant Distribution, Orientation: Vertical, Magnitude: 1500 lb/ft²
Distributed Load #2 Triangular Distribution, Orientation: Vertical, Magnitudes 1,2: 1500 and 0 lb/ft²
Distributed Load #3 Triangular Distribution, Orientation: Vertical, Magnitudes 1,2: 1500 and 0 lb/ft²

Material Properties

Material: Bedrock
Strength Type: Mohr-Coulomb
Unit Weight: 100 lb/ft³

Cohesion: 1196 psf
Friction Angle: 38 degrees
Water Surface: None
Ru value: 0

Material: Alluvium
Strength Type: Mohr-Coulomb
Unit Weight: 110 lb/ft³
Cohesion: 150 psf
Friction Angle: 30 degrees
Water Surface: None
Ru value: 0

Support Properties

Support: Soil Nail Seismic
Soil Nail Seismic
Support Type: Soil Nail
Force Application: Passive
Out-of-Plane Spacing: 5 ft
Tensile Capacity: 43889 lb
Plate Capacity: 37100 lb
Bond Strength: 1508 lb/ft
and Material Dependent

Global Minimums

Method: bishop simplified
FS: 1.160470
Center: 178.908, 859.648
Radius: 149.331
Left Slip Surface Endpoint: 73.246, 754.123
Right Slip Surface Endpoint: 134.377, 717.110
Resisting Moment=1.97251e+007 lb-ft
Driving Moment=1.69976e+007 lb-ft

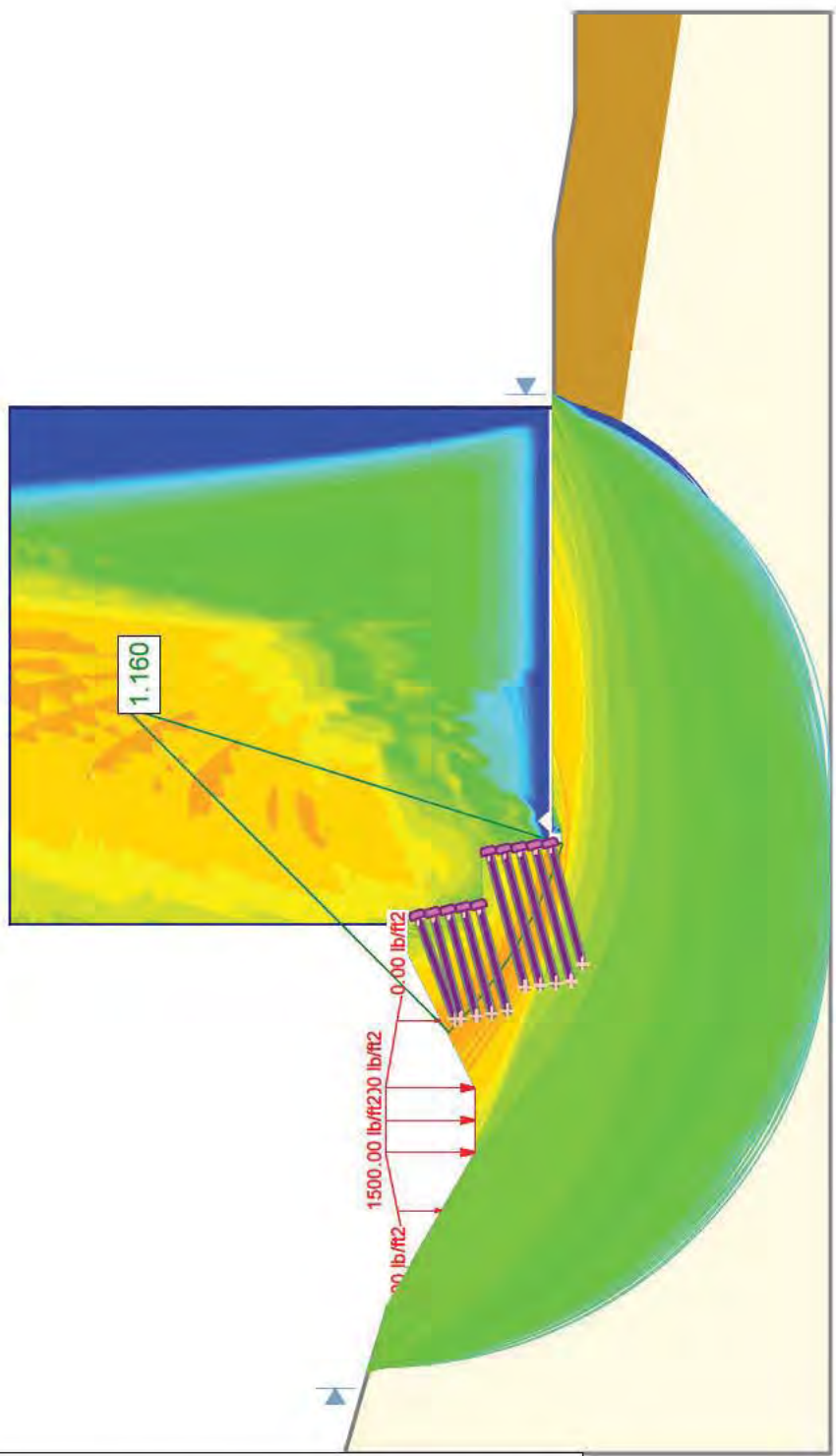
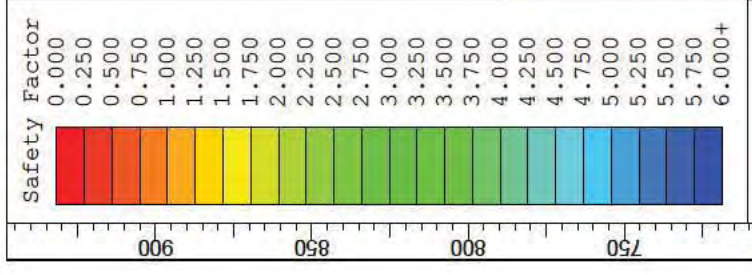

File Name: DRS3 BG3 dN EQ.sli

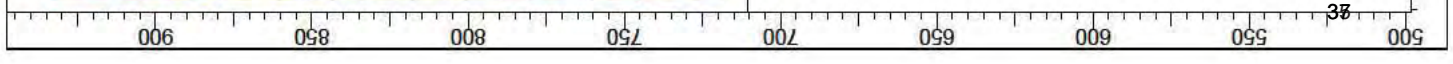
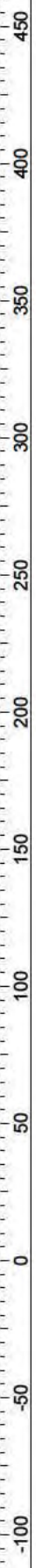

Slide Analysis Information

Document Name

File Name: DRS4 BG1 bN ST.sli

Project Settings

Project Title: Harvard-Westlake
Failure Direction: Left to Right
Units of Measurement: Imperial Units
Pore Fluid Unit Weight: 62.4 lb/ft³
Groundwater Method: Water Surfaces
Data Output: Standard
Calculate Excess Pore Pressure: Off
Allow Ru with Water Surfaces or Grids: On
Random Numbers: Pseudo-random Seed
Random Number Seed: 10116
Random Number Generation Method: Park and Miller v.3

Analysis Methods

Analysis Methods used:
Bishop simplified

Number of slices: 25
Tolerance: 0.005
Maximum number of iterations: 50

Surface Options

Surface Type: Circular
Search Method: Grid Search
Radius increment: 10
Composite Surfaces: Disabled
Reverse Curvature: Create Tension Crack
Minimum Elevation: Not Defined
Minimum Depth: Not Defined

Material Properties

Material: Bedrock
Strength Type: Mohr-Coulomb
Unit Weight: 100 lb/ft³
Cohesion: 1044 psf
Friction Angle: 36.5 degrees
Water Surface: None
Ru value: 0

Material: Fill
Strength Type: Mohr-Coulomb
Unit Weight: 120 lb/ft³
Cohesion: 400 psf
Friction Angle: 30 degrees
Water Surface: None

Ru value: 0

Support Properties

Support: Soil Nail Static

Soil Nail Static

Support Type: Soil Nail

Force Application: Passive

Out-of-Plane Spacing: 5 ft

Tensile Capacity: 25000 lb

Plate Capacity: 37100 lb

Bond Strength: 1810 lb/ft

and Material Dependent

Global Minimums

Method: bishop simplified

FS: 1.564260

Center: 310.984, 904.855

Radius: 210.498

Left Slip Surface Endpoint: 115.866, 825.871

Right Slip Surface Endpoint: 227.014, 711.830

Resisting Moment=9.6873e+007 lb-ft

Driving Moment=6.19291e+007 lb-ft

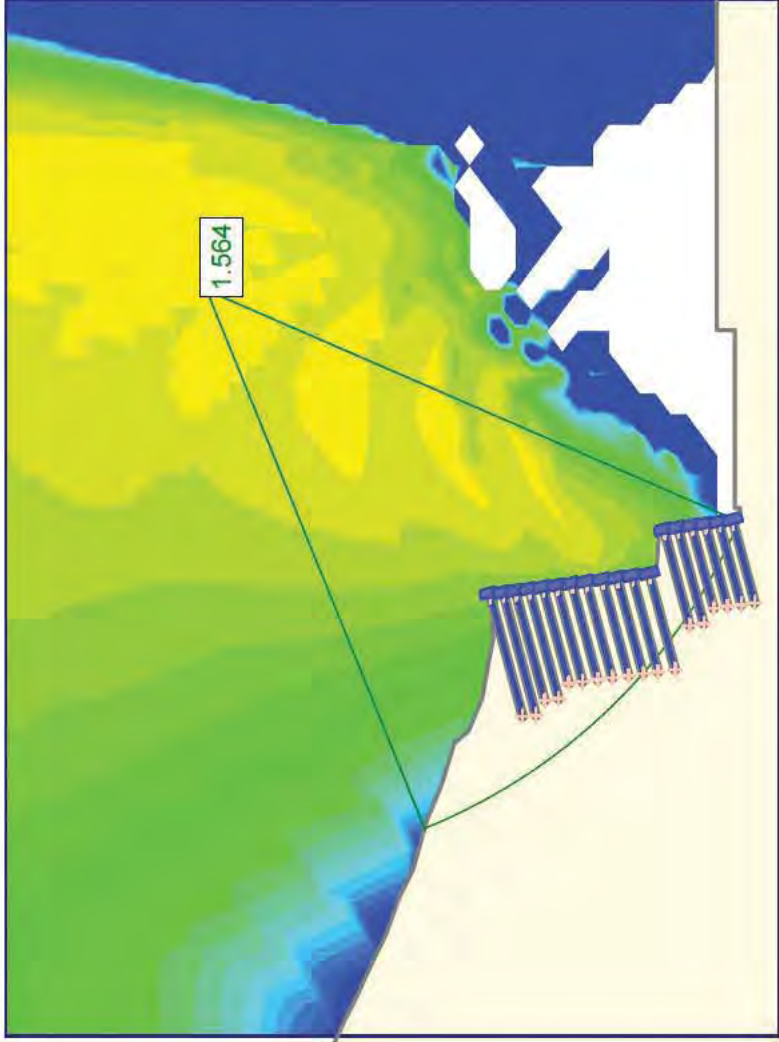
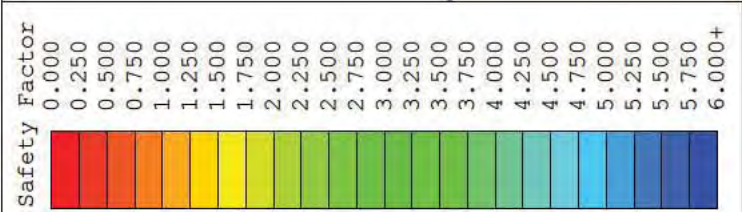

File Name: DRS4 BG1 bN ST.sli

500

400

300

200

100

0

-100

600

700

800

900

1000

Slide Analysis Information

Document Name

File Name: DRS4 BG1 dN EQ.sli

Project Settings

Project Title: Harvard-Westlake
Failure Direction: Left to Right
Units of Measurement: Imperial Units
Pore Fluid Unit Weight: 62.4 lb/ft³
Groundwater Method: Water Surfaces
Data Output: Standard
Calculate Excess Pore Pressure: Off
Allow Ru with Water Surfaces or Grids: On
Random Numbers: Pseudo-random Seed
Random Number Seed: 10116
Random Number Generation Method: Park and Miller v.3

Analysis Methods

Analysis Methods used:
Bishop simplified

Number of slices: 25
Tolerance: 0.005
Maximum number of iterations: 50

Surface Options

Surface Type: Circular
Search Method: Grid Search
Radius increment: 10
Composite Surfaces: Disabled
Reverse Curvature: Create Tension Crack
Minimum Elevation: Not Defined
Minimum Depth: Not Defined

Loading

Seismic Load Coefficient (Horizontal): 0.27

Material Properties

Material: Bedrock
Strength Type: Mohr-Coulomb
Unit Weight: 100 lb/ft³
Cohesion: 1196 psf
Friction Angle: 38 degrees
Water Surface: None
Ru value: 0

Material: Fill

Strength Type: Mohr-Coulomb
Unit Weight: 120 lb/ft³
Cohesion: 400 psf
Friction Angle: 30 degrees
Water Surface: None
Ru value: 0

Support Properties

Support: Soil Nail Seismic
Soil Nail Seismic
Support Type: Soil Nail
Force Application: Passive
Out-of-Plane Spacing: 5 ft
Tensile Capacity: 33333 lb
Plate Capacity: 37100 lb
Bond Strength: 2413 lb/ft
and Material Dependent

Global Minimums

Method: bishop simplified
FS: 1.216260
Center: 333.516, 949.683
Radius: 260.759
Left Slip Surface Endpoint: 101.986, 829.726
Right Slip Surface Endpoint: 227.039, 711.653
Resisting Moment=1.32162e+008 lb-ft
Driving Moment=1.08663e+008 lb-ft

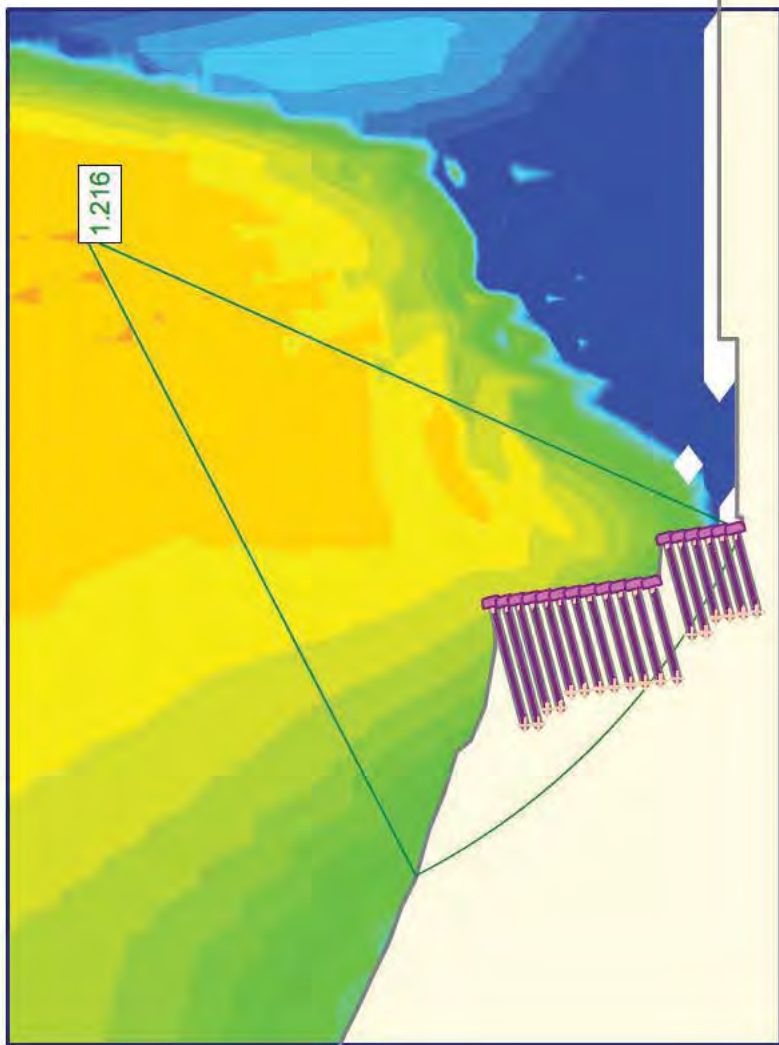
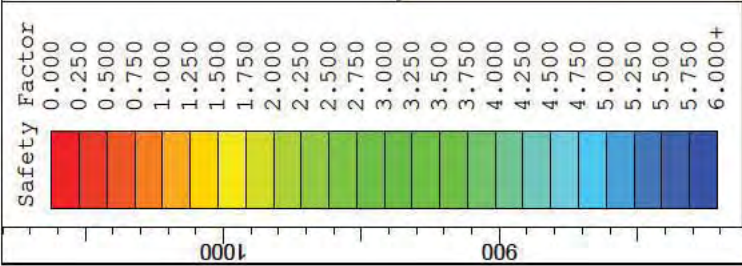

File Name: DRS4 BG1 dN EQ.sli

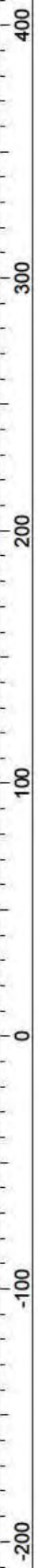

Slide Analysis Information

Document Name

File Name: DRS5 BG6 bN ST 10 to 1 slope.sli

Project Settings

Project Title: Harvard-Westlake
Failure Direction: Left to Right
Units of Measurement: Imperial Units
Pore Fluid Unit Weight: 62.4 lb/ft³
Groundwater Method: Water Surfaces
Data Output: Standard
Calculate Excess Pore Pressure: Off
Allow Ru with Water Surfaces or Grids: On
Random Numbers: Pseudo-random Seed
Random Number Seed: 10116
Random Number Generation Method: Park and Miller v.3

Analysis Methods

Analysis Methods used:
Bishop simplified

Number of slices: 25
Tolerance: 0.005
Maximum number of iterations: 50

Surface Options

Surface Type: Circular
Search Method: Grid Search
Radius increment: 10
Composite Surfaces: Disabled
Reverse Curvature: Create Tension Crack
Minimum Elevation: Not Defined
Minimum Depth: Not Defined

Material Properties

Material: Fill

Strength Type: Mohr-Coulomb
Unit Weight: 120 lb/ft³
Cohesion: 400 psf
Friction Angle: 30 degrees
Water Surface: None
Ru value: 0

Material: Bedrock

Strength Type: Mohr-Coulomb
Unit Weight: 100 lb/ft³
Cohesion: 1044 psf
Friction Angle: 36.5 degrees
Water Surface: None

Ru value: 0

Material: Alluvium

Strength Type: Mohr-Coulomb

Unit Weight: 100 lb/ft³

Cohesion: 150 psf

Friction Angle: 30 degrees

Water Surface: None

Ru value: 0

Support Properties

Support: Soil Nail Static

Soil Nail Static

Support Type: Soil Nail

Force Application: Passive

Out-of-Plane Spacing: 5 ft

Tensile Capacity: 25000 lb

Plate Capacity: 37100 lb

Bond Strength: 1810 lb/ft
and Material Dependent

Global Minimums

Method: bishop simplified

FS: 1.599180

Center: 160.142, 789.141

Radius: 83.211

Left Slip Surface Endpoint: 77.137, 783.295

Right Slip Surface Endpoint: 121.983, 715.195

Resisting Moment=1.62461e+007 lb-ft

Driving Moment=1.0159e+007 lb-ft

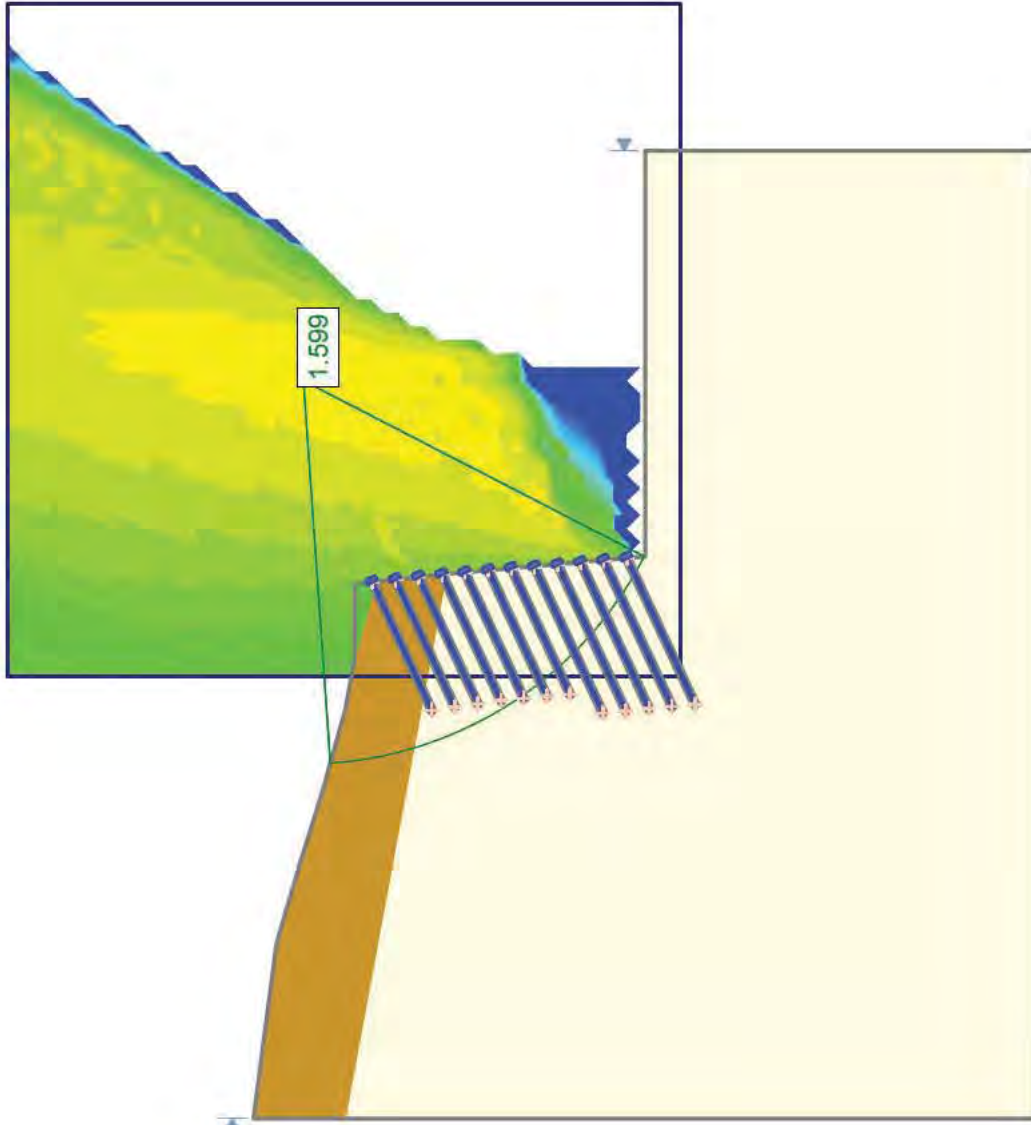
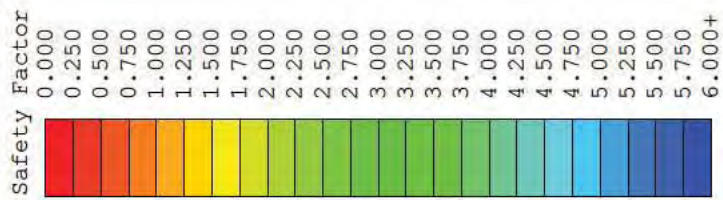

File Name: DRS5 BG6 bN ST 10 to 1 slope.sli

600 650 700 750 800 850 -50 0 50 100 150 200 250 300

Slide Analysis Information

Document Name

File Name: DRS5 BG6 bN EQ 10 to 1 slope.sli

Project Settings

Project Title: Harvard-Westlake
Failure Direction: Left to Right
Units of Measurement: Imperial Units
Pore Fluid Unit Weight: 62.4 lb/ft³
Groundwater Method: Water Surfaces
Data Output: Standard
Calculate Excess Pore Pressure: Off
Allow Ru with Water Surfaces or Grids: On
Random Numbers: Pseudo-random Seed
Random Number Seed: 10116
Random Number Generation Method: Park and Miller v.3

Analysis Methods

Analysis Methods used:
Bishop simplified

Number of slices: 25
Tolerance: 0.005
Maximum number of iterations: 50

Surface Options

Surface Type: Circular
Search Method: Grid Search
Radius increment: 10
Composite Surfaces: Disabled
Reverse Curvature: Create Tension Crack
Minimum Elevation: Not Defined
Minimum Depth: Not Defined

Loading

Seismic Load Coefficient (Horizontal): 0.27

Material Properties

Material: Fill
Strength Type: Mohr-Coulomb
Unit Weight: 120 lb/ft³
Cohesion: 400 psf
Friction Angle: 30 degrees
Water Surface: None
Ru value: 0

Material: Bedrock

Strength Type: Mohr-Coulomb
Unit Weight: 100 lb/ft³
Cohesion: 1196 psf
Friction Angle: 38 degrees
Water Surface: None
Ru value: 0

Material: Alluvium
Strength Type: Mohr-Coulomb
Unit Weight: 100 lb/ft³
Cohesion: 150 psf
Friction Angle: 30 degrees
Water Surface: None
Ru value: 0

Support Properties

Support: Soil Nail Seismic
Soil Nail Seismic
Support Type: Soil Nail
Force Application: Passive
Out-of-Plane Spacing: 5 ft
Tensile Capacity: 33333 lb
Plate Capacity: 37100 lb
Bond Strength: 2413 lb/ft
and Material Dependent

Global Minimums

Method: bishop simplified
FS: 1.388270
Center: 163.061, 812.493
Radius: 105.711
Left Slip Surface Endpoint: 60.133, 788.396
Right Slip Surface Endpoint: 121.992, 715.085
Resisting Moment=2.71575e+007 lb-ft
Driving Moment=1.95621e+007 lb-ft

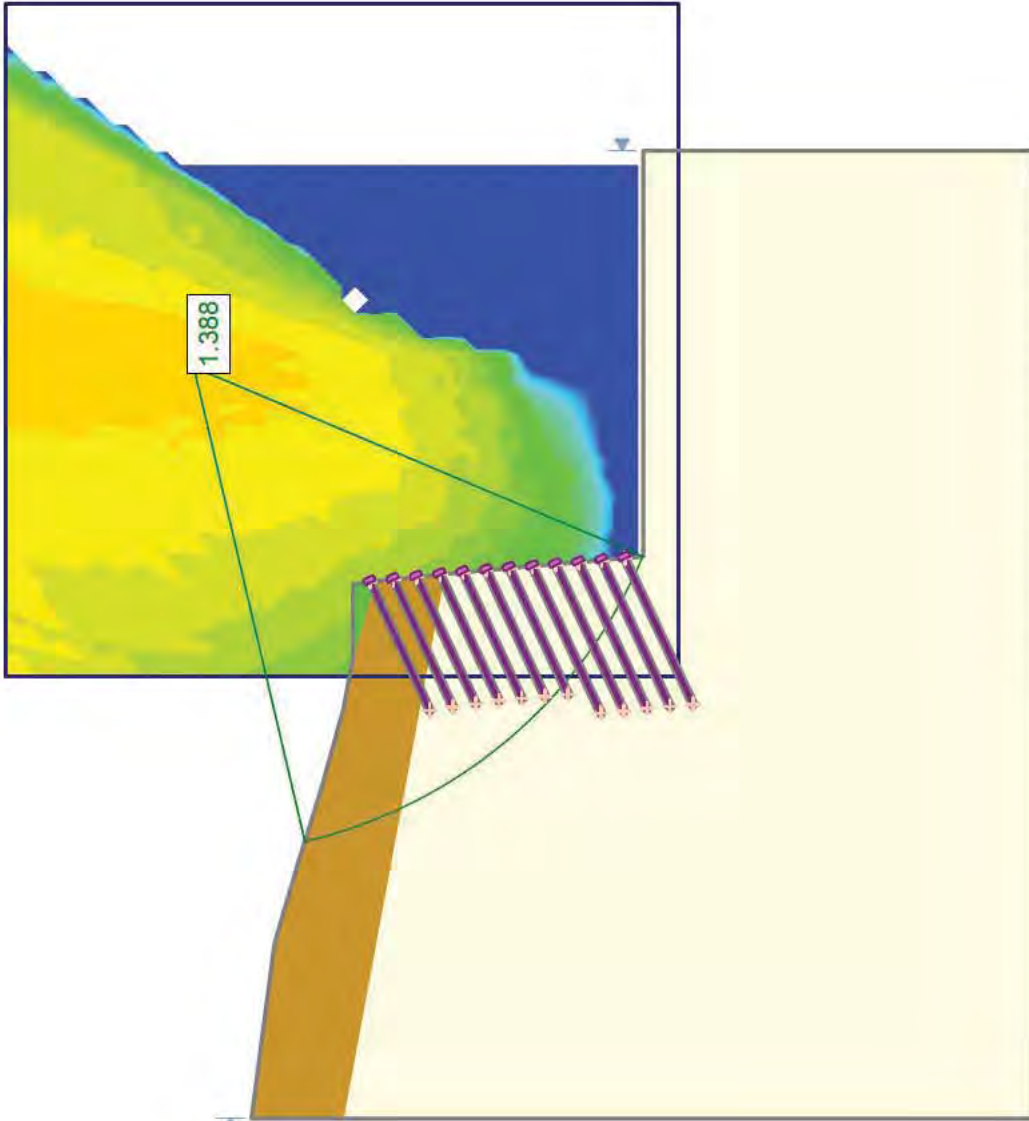
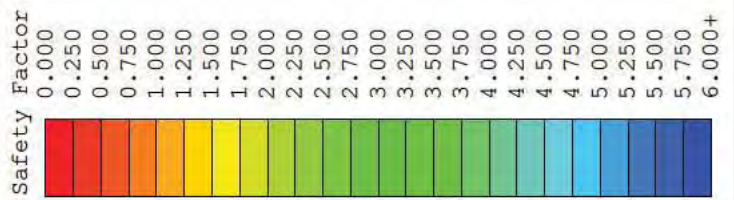

File Name: DRS5 BG6 bN EQ 10 to 1 slope.sli

600 650 700 750 800 850 -50 0 50 100 150 200 250 300

Slide Analysis Information

Document Name

File Name: DRS6 BG7 bN ST

Project Settings

Project Title: Harvard-Westlake
Failure Direction: Right to Left
Units of Measurement: Imperial Units
Pore Fluid Unit Weight: 62.4 lb/ft³
Groundwater Method: Water Surfaces
Data Output: Standard
Calculate Excess Pore Pressure: Off
Allow Ru with Water Surfaces or Grids: On
Random Numbers: Pseudo-random Seed
Random Number Seed: 10116
Random Number Generation Method: Park and Miller v.3

Analysis Methods

Analysis Methods used:
Bishop simplified

Number of slices: 25
Tolerance: 0.005
Maximum number of iterations: 50

Surface Options

Surface Type: Circular
Search Method: Grid Search
Radius increment: 10
Composite Surfaces: Disabled
Reverse Curvature: Create Tension Crack
Minimum Elevation: Not Defined
Minimum Depth: Not Defined

Material Properties

Material: Fill

Strength Type: Mohr-Coulomb
Unit Weight: 120 lb/ft³
Cohesion: 400 psf
Friction Angle: 30 degrees
Water Surface: None
Ru value: 0

Material: Bedrock

Strength Type: Mohr-Coulomb
Unit Weight: 100 lb/ft³
Cohesion: 1044 psf
Friction Angle: 36.5 degrees
Water Surface: None

Ru value: 0

Support Properties

Support: Soil Nail Static
Soil Nail Static
Support Type: Soil Nail
Force Application: Passive
Out-of-Plane Spacing: 5 ft
Tensile Capacity: 25000 lb
Plate Capacity: 37100 lb
Bond Strength: 905 lb/ft
and Material Dependent

Global Minimums

Method: bishop simplified
FS: 1.785220
Center: 571.615, 750.988
Radius: 33.546
Left Slip Surface Endpoint: 589.270, 722.464
Right Slip Surface Endpoint: 605.161, 750.988
Left Slope Intercept: 589.270 722.464
Right Slope Intercept: 605.161 776.263
Resisting Moment=2.66671e+006 lb-ft
Driving Moment=1.49377e+006 lb-ft

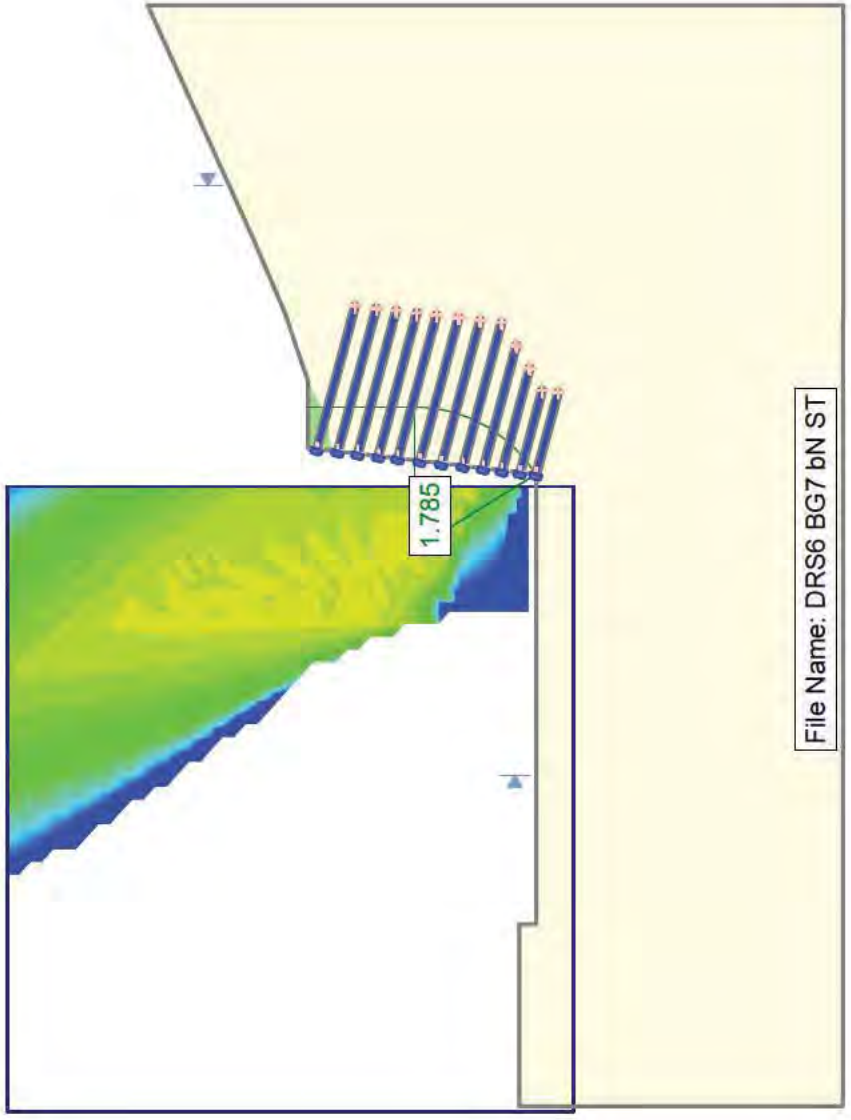
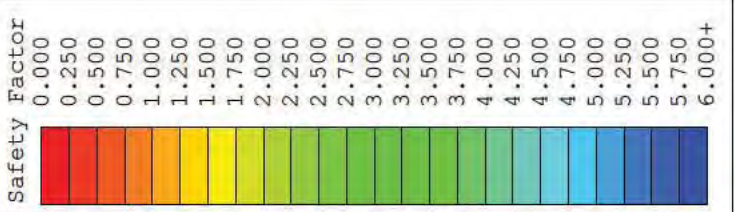

350 400 450 500 550 600 650 700 750

Slide Analysis Information

Document Name

File Name: DRS6 BG7 dN EQ

Project Settings

Project Title: Harvard-Westlake
Failure Direction: Right to Left
Units of Measurement: Imperial Units
Pore Fluid Unit Weight: 62.4 lb/ft³
Groundwater Method: Water Surfaces
Data Output: Standard
Calculate Excess Pore Pressure: Off
Allow Ru with Water Surfaces or Grids: On
Random Numbers: Pseudo-random Seed
Random Number Seed: 10116
Random Number Generation Method: Park and Miller v.3

Analysis Methods

Analysis Methods used:
Bishop simplified

Number of slices: 25
Tolerance: 0.005
Maximum number of iterations: 50

Surface Options

Surface Type: Circular
Search Method: Grid Search
Radius increment: 10
Composite Surfaces: Disabled
Reverse Curvature: Create Tension Crack
Minimum Elevation: Not Defined
Minimum Depth: Not Defined

Loading

Seismic Load Coefficient (Horizontal): 0.27

Material Properties

Material: Fill
Strength Type: Mohr-Coulomb
Unit Weight: 120 lb/ft³
Cohesion: 400 psf
Friction Angle: 30 degrees
Water Surface: None
Ru value: 0

Material: Bedrock

Strength Type: Mohr-Coulomb
Unit Weight: 108 lb/ft³
Cohesion: 1196 psf
Friction Angle: 38 degrees
Water Surface: None
Ru value: 0

Support Properties

Support: Soil Nail Seismic
Soil Nail Seismic
Support Type: Soil Nail
Force Application: Passive
Out-of-Plane Spacing: 5 ft
Tensile Capacity: 33333 lb
Plate Capacity: 37100 lb
Bond Strength: 1207 lb/ft
and Material Dependent

Global Minimums

Method: bishop simplified
FS: 1.481950
Center: 556.844, 817.778
Radius: 100.609
Left Slip Surface Endpoint: 589.279, 722.541
Right Slip Surface Endpoint: 654.491, 793.547
Resisting Moment=2.6423e+007 lb-ft
Driving Moment=1.78298e+007 lb-ft

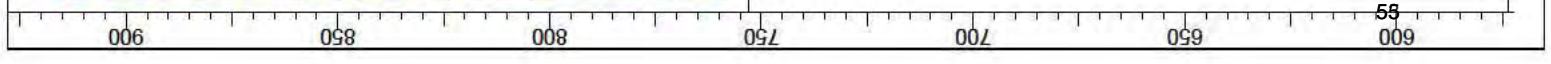
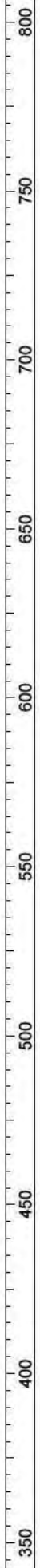
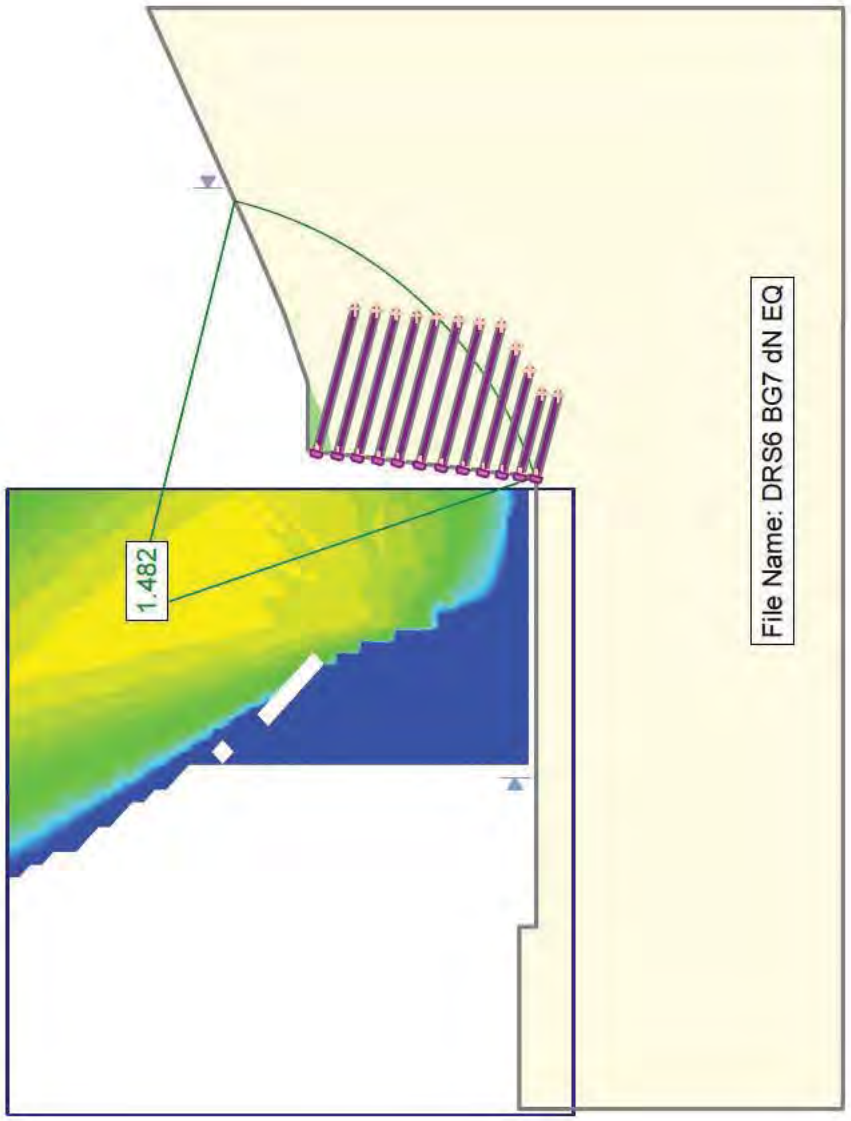
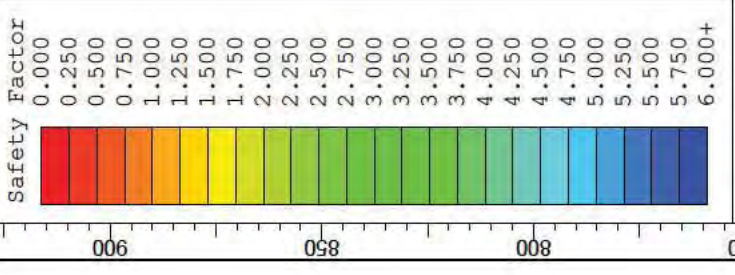

Slide Analysis Information

Document Name

File Name: DRS7 BG7 bN ST

Project Settings

Project Title: Harvard-Westlake
Failure Direction: Left to Right
Units of Measurement: Imperial Units
Pore Fluid Unit Weight: 62.4 lb/ft³
Groundwater Method: Water Surfaces
Data Output: Standard
Calculate Excess Pore Pressure: Off
Allow Ru with Water Surfaces or Grids: On
Random Numbers: Pseudo-random Seed
Random Number Seed: 10116
Random Number Generation Method: Park and Miller v.3

Analysis Methods

Analysis Methods used:
Bishop simplified

Number of slices: 25
Tolerance: 0.005
Maximum number of iterations: 50

Surface Options

Surface Type: Circular
Search Method: Grid Search
Radius increment: 10
Composite Surfaces: Disabled
Reverse Curvature: Create Tension Crack
Minimum Elevation: Not Defined
Minimum Depth: Not Defined

Material Properties

Material: Bedrock
Strength Type: Mohr-Coulomb
Unit Weight: 100 lb/ft³
Cohesion: 1044 psf
Friction Angle: 36.5 degrees
Water Surface: None
Ru value: 0

Material: Alluvium
Strength Type: Mohr-Coulomb
Unit Weight: 110 lb/ft³
Cohesion: 150 psf
Friction Angle: 30 degrees
Water Surface: None

Ru value: 0

Support Properties

Support: Soil Nail Static

Soil Nail Static

Support Type: Soil Nail

Force Application: Passive

Out-of-Plane Spacing: 5 ft

Tensile Capacity: 25000 lb

Plate Capacity: 37100 lb

Bond Strength: 1810 lb/ft
and Material Dependent

Global Minimums

Method: bishop simplified

FS: 2.245680

Center: 646.194, 958.686

Radius: 260.518

Left Slip Surface Endpoint: 423.700, 823.164

Right Slip Surface Endpoint: 592.905, 703.676

Resisting Moment=1.50605e+008 lb-ft

Driving Moment=6.70641e+007 lb-ft

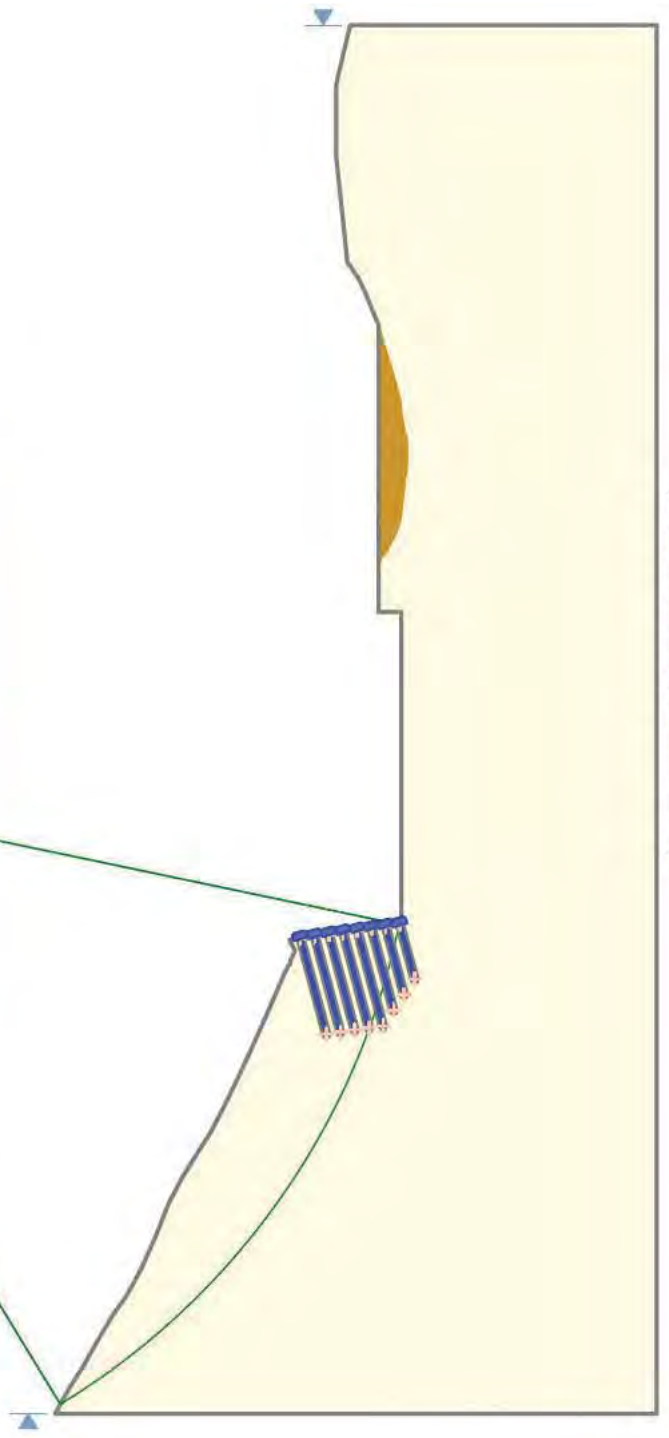
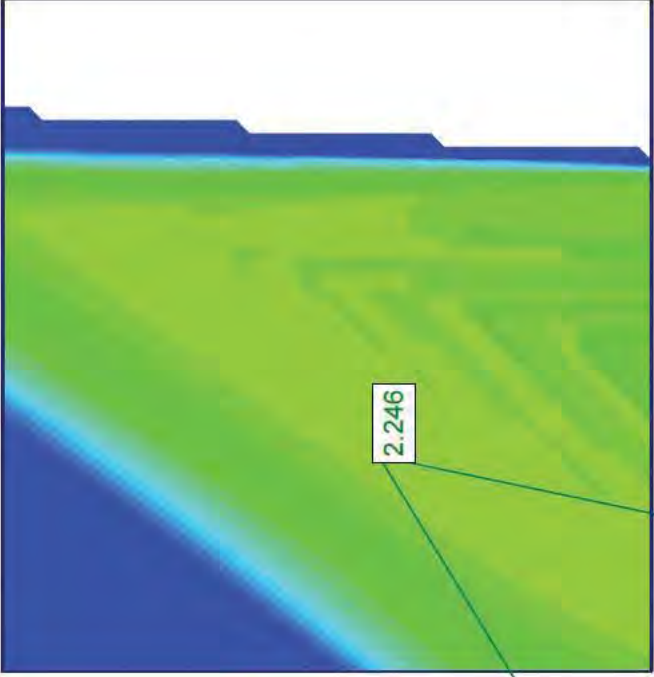
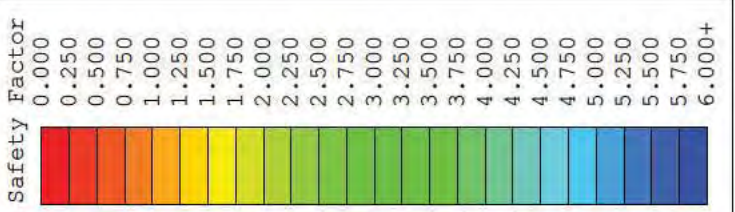

File Name: DRS7 BG7 bN ST

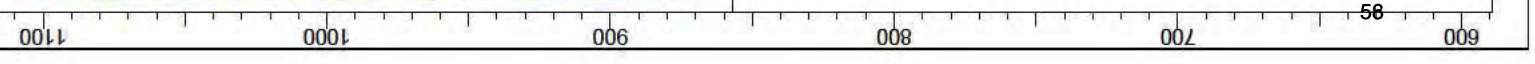

Slide Analysis Information

Document Name

File Name: DRS7 BG7 dN EQ

Project Settings

Project Title: Harvard-Westlake
Failure Direction: Left to Right
Units of Measurement: Imperial Units
Pore Fluid Unit Weight: 62.4 lb/ft³
Groundwater Method: Water Surfaces
Data Output: Standard
Calculate Excess Pore Pressure: Off
Allow Ru with Water Surfaces or Grids: On
Random Numbers: Pseudo-random Seed
Random Number Seed: 10116
Random Number Generation Method: Park and Miller v.3

Analysis Methods

Analysis Methods used:
Bishop simplified

Number of slices: 25
Tolerance: 0.005
Maximum number of iterations: 50

Surface Options

Surface Type: Circular
Search Method: Grid Search
Radius increment: 10
Composite Surfaces: Disabled
Reverse Curvature: Create Tension Crack
Minimum Elevation: Not Defined
Minimum Depth: Not Defined

Loading

Seismic Load Coefficient (Horizontal): 0.27

Material Properties

Material: Bedrock
Strength Type: Mohr-Coulomb
Unit Weight: 100 lb/ft³
Cohesion: 1196 psf
Friction Angle: 38 degrees
Water Surface: None
Ru value: 0

Material: Alluvium

Strength Type: Mohr-Coulomb
Unit Weight: 110 lb/ft³
Cohesion: 150 psf
Friction Angle: 30 degrees
Water Surface: None
Ru value: 0

Support Properties

Support: Soil Nail Seismic
Soil Nail Seismic
Support Type: Soil Nail
Force Application: Passive
Out-of-Plane Spacing: 5 ft
Tensile Capacity: 33333 lb
Plate Capacity: 37100 lb
Bond Strength: 2413 lb/ft
and Material Dependent

Global Minimums

Method: bishop simplified
FS: 1.573200
Center: 646.194, 958.686
Radius: 260.518
Left Slip Surface Endpoint: 423.700, 823.164
Right Slip Surface Endpoint: 592.905, 703.676
Resisting Moment=1.51403e+008 lb-ft
Driving Moment=9.62384e+007 lb-ft

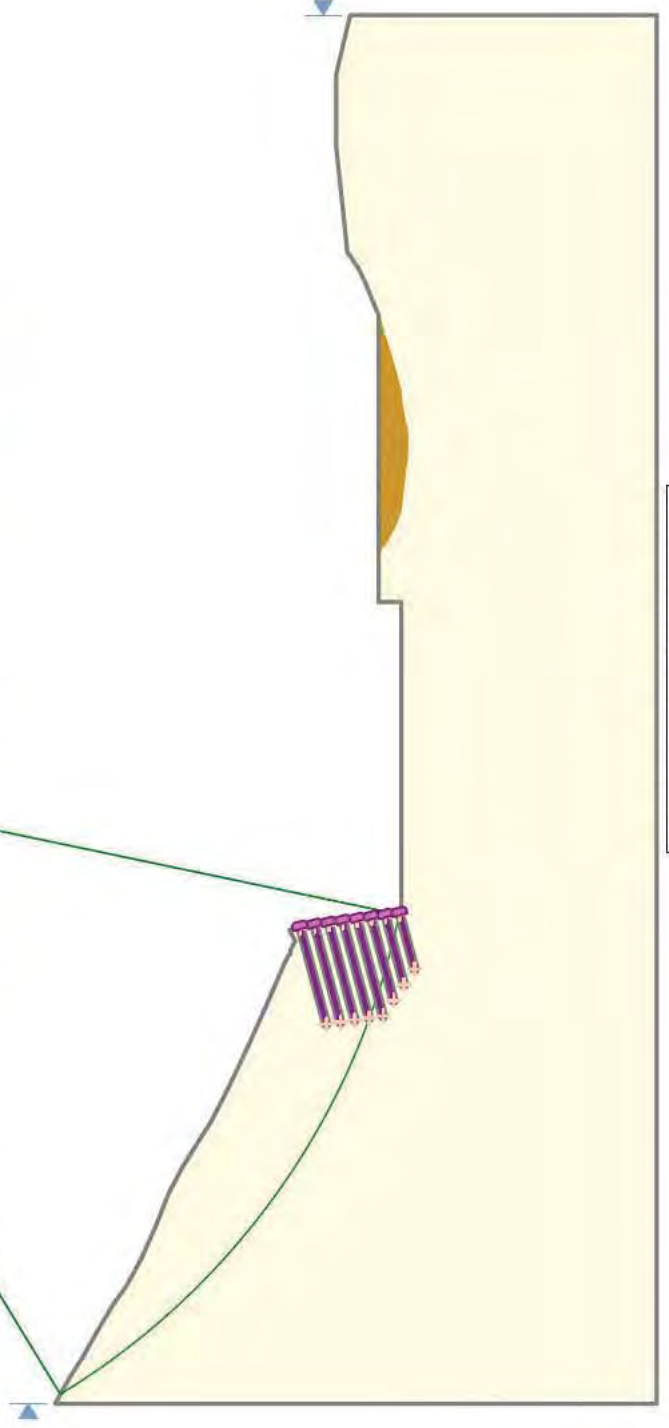
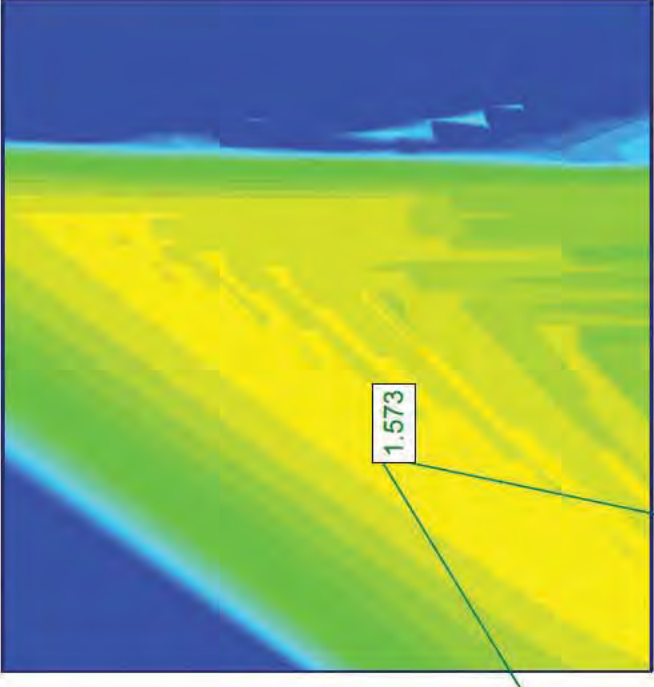
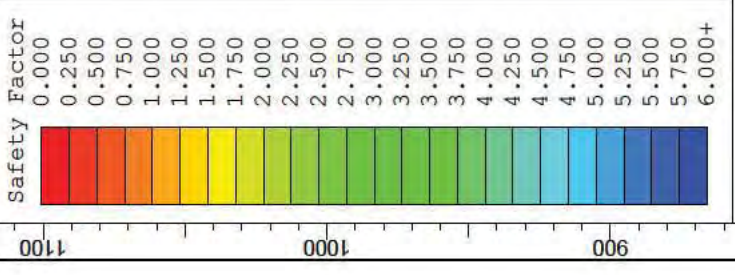

File Name: DRS7 BG7 dN EQ

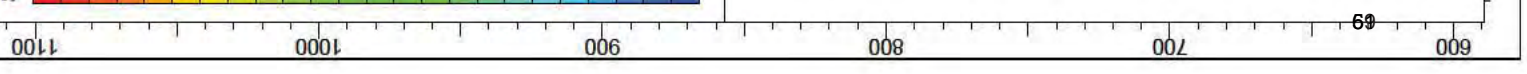

APPENDIX B

EFP Check



Data on Active Wedge and EFP from Byer Geotechnical

DRS Section 4

BG 21898 HARVARD WESTLAKE SECTION 1

CALCULATE THE MINIMUM REQUIRED EFP APPLIED TO THE FACE OF THE PROPOSED SOIL NAIL CONFIGURATION TO ACHIEVE A MINIMUM FACTOR OF SAFETY OF 1.5.

THE RESULTS INDICATE THAT AN EFP OF 10 PCF WILL ACHIEVE A FACTOR OF SAFETY IN EXCESS OF 1.5.

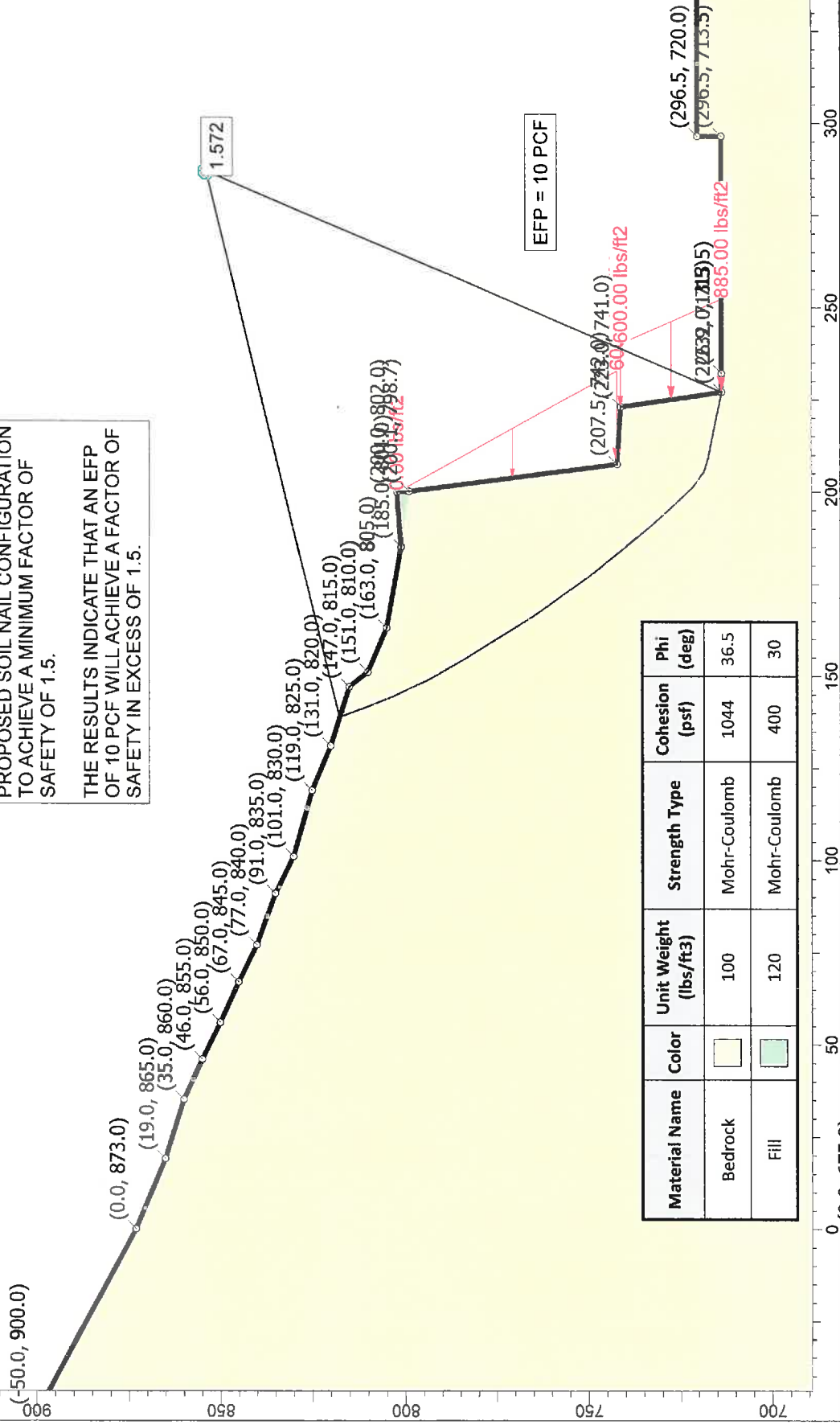

Project		BG 21898 HARVARD-WESTLAKE SECTION 1	
Analysis Description		CALCULATE THE MINIMUM REQUIRED EFP APPLIED TO SOIL NAIL WALLS TO ACHIEVE FS=1.5	
Drawn By	R. ZWEIFLER	Scale	1:505
Date	5/18/15	Company	BYER GEOTECHNICAL, INC.
		File Name	21898 Section 1 efp.slm



0.29



DRS Section 4

BG 21898 HARVARD WESTLAKE
SECTION 1

CALCULATE THE MINIMUM REQUIRED EFP TO GENERATE A FACTOR OF SAFETY OF 1.0 UNDER SEISMIC LOADING, APPLIED ON THE FACE OF THE PROPOSED SOIL NAIL RETAINING WALLS. NOTE: THE SEARCH WAS LIMITED TO THE UPSLOPE DISTANCE RESULTING IN THE MOST CRITICAL FAILURE UNDER STATIC CONDITIONS.

THE RESULTS INDICATE THAT AN EFP OF 30 PCF WILL ACHIEVE A FACTOR OF SAFETY OF GREATER THAN 1.0 UNDER SEISMIC LOADING.

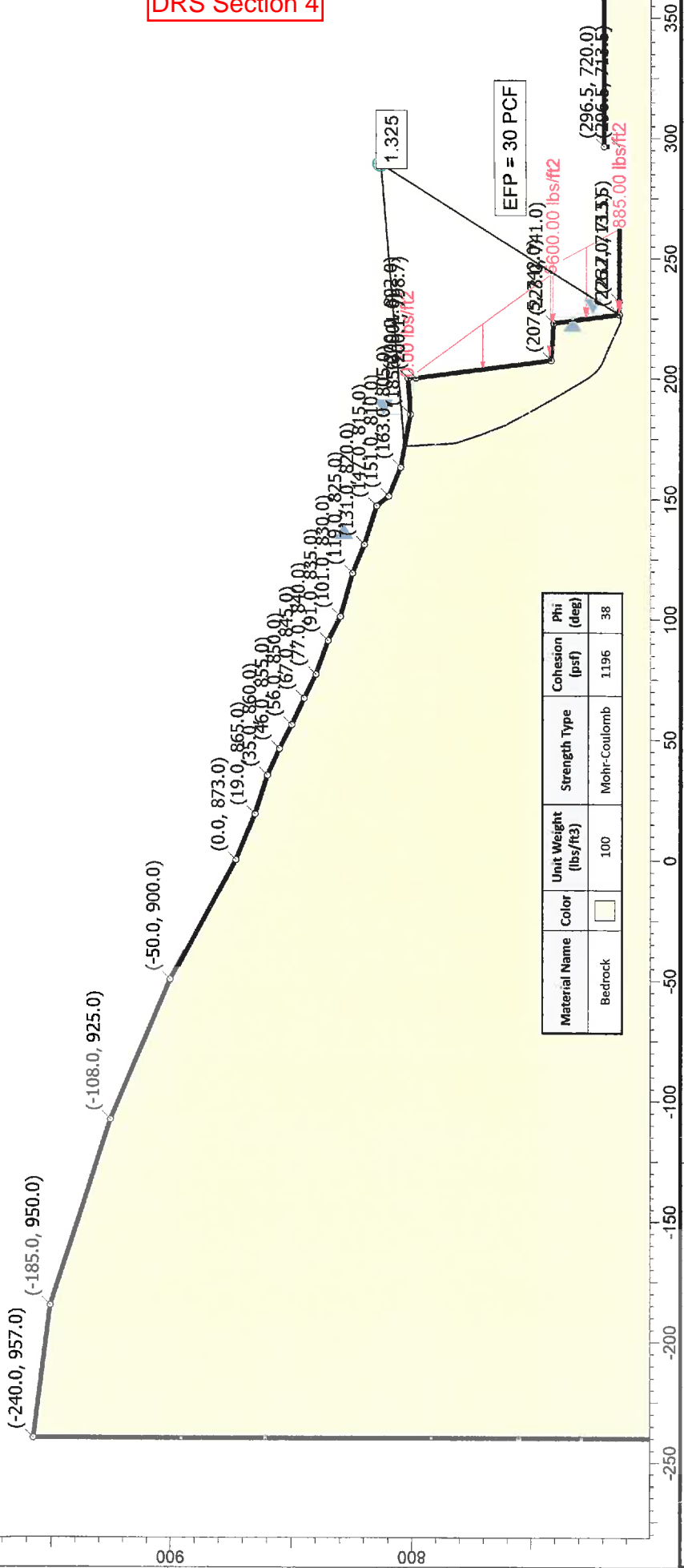

BG 21898 HARVARD-WESTLAKE SECTION 1

BYER GEOTECHNICAL INC.

ANALYSIS DESCRIPTION: CALCULATE THE MINIMUM REQUIRED EFP APPLIED TO SOIL NAIL WALLS TO ACHIEVE FS=1.0 (SEISMIC)

DRAWN BY: R. ZWEIGLER

SCALE: 1:770

COMPANY: BYER GEOTECHNICAL, INC.

DATE: 5/18/15

FILE NAME: 21898 Section 1 efp EQ.slim

1.514

DRS Section 4

BG 21898 HARVARD WESTLAKE SECTION 1
 CALCULATE THE MINIMUM REQUIRED EFP TO GENERATE A FACTOR OF SAFETY OF 1.5, APPLIED SO AS TO REPRESENT THE MINIMUM REQUIRED EFP TO REPRESENT A SOIL NAIL RETAINING WALL.
 THE RESULTS INDICATE THAT AN EFP OF 30 PCF WILL ACHIEVE A FACTOR OF SAFETY OF GREATER THAN 1.5.

Material Name	Color	Unit Weight (lbs/ft ³)	Strength Type	Cohesion (pcf)	Phi (deg)
Bedrock	<input type="checkbox"/>	100	Mohr-Coulomb	1004	36.5

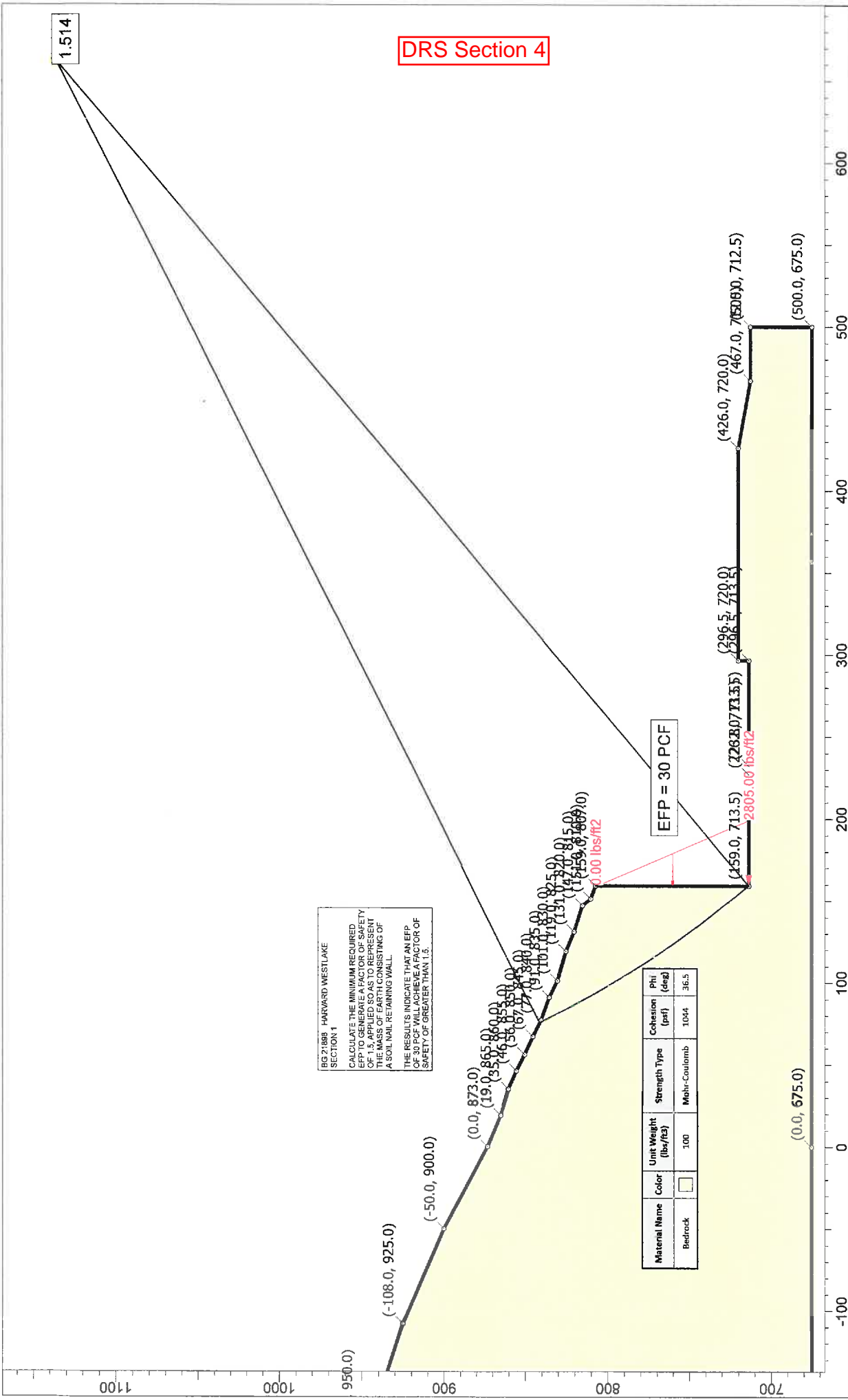

BYER GEOTECHNICAL INC.

Project: BG 21898 HARVARD-WESTLAKE SECTION 1

Analysis Description: CALCULATE THE MINIMUM REQUIRED EFP TO REPRESENT SOIL NAIL EARTH BLOCK

Drawn By: R. ZWEIGLER Scale: 1:970 Company: BYER GEOTECHNICAL, INC.

Date: 5/18/15 File Name: 21898 Section 1 efp on back of soil nail wall.slim

SLIDENTERPRET 6.035

DRS Section 4

BG 21898 HARVARD WESTLAKE SECTION 1
 CALCULATE THE MINIMUM REQUIRED EFP TO GENERATE A FACTOR OF SAFETY OF 1.0 UNDER SEISMIC LOADING. APPLIED SO AS TO REPRESENT THE MASS OF EARTH CONSISTING OF A SOIL NAIL RETAINING WALL. NOTE: THE SEARCH DISTANCE OF THE CRITICAL FAILURE SURFACE IS LIMITED TO THE SPACING UNDER STATIC CONDITIONS.
 THE RESULTS INDICATE THAT AN EFP OF 30 PCF WILL ACHIEVE A FACTOR OF SAFETY OF GREATER THAN 1.0 UNDER SEISMIC LOADING.

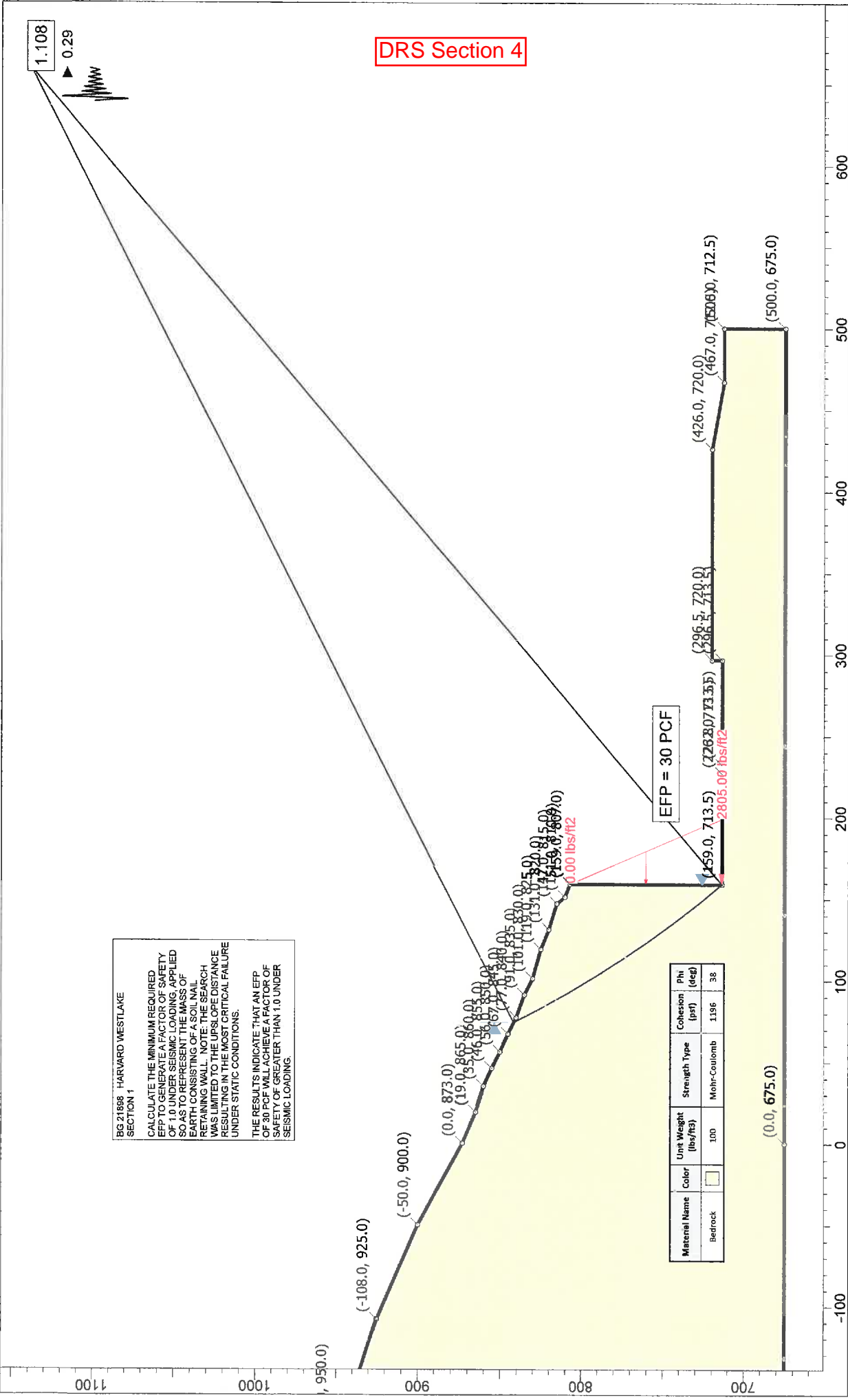

Material Name	Color	Unit Weight (lbs/ft3)	Strength Type	Cohesion (pcf)	Phi (deg)
Bedrock		100	Mohr-Coulomb	1186	38

Project: BG 21898 HARVARD-WESTLAKE SECTION 1

Analysis Description: CALCULATE THE MINIMUM REQUIRED EFP TO REPRESENT SOIL NAIL EARTH BLOCK (SEISMIC)

Drawn By: R. ZWEIGLER Scale: 1:977 Company: BYER GEOTECHNICAL, INC.

Date: 5/18/15 File Name: 21898 Section 1 efp on back of soil nail wall EQ.slim

BYER GEOTECHNICAL INC.

84

SLIDEINTERPRET 6.035

BG 21898 HARVARD WESTLAKE
SECTION 3

CALCULATE THE MINIMUM REQUIRED
EFP APPLIED TO THE FACE OF THE
PROPOSED SOIL NAIL CONFIGURATION
TO ACHIEVE A FACTOR OF SAFETY
OF 1.5.

THE RESULTS INDICATE THAT AN EFP
OF 20 PCF WILL ACHIEVE A FACTOR OF
SAFETY IN EXCESS OF 1.5.

DRS Section 3

EFP = 20 PCF

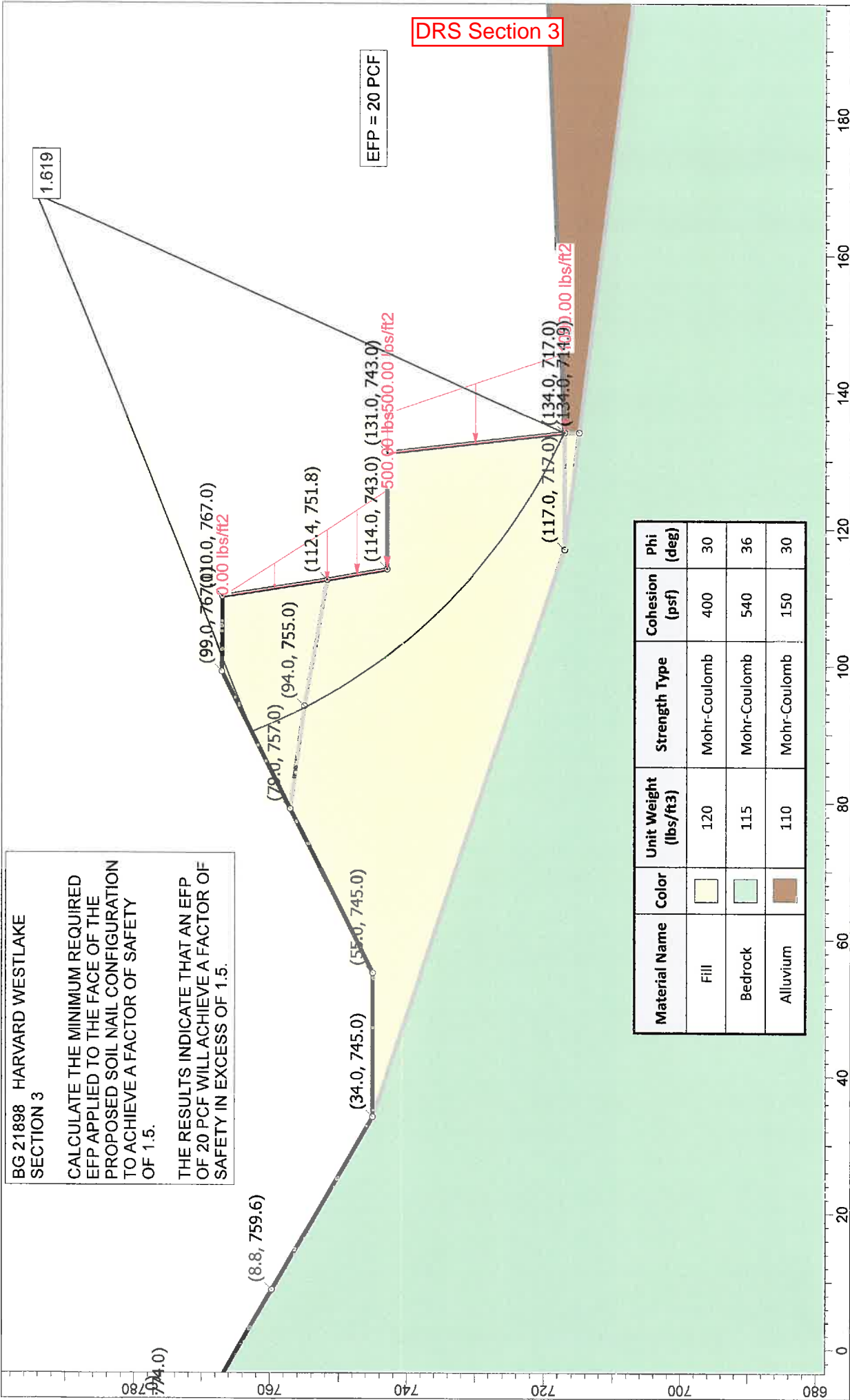

Material Name	Color	Unit Weight (lbs/ft3)	Strength Type	Cohesion (psf)	Phi (deg)
Fill		120	Mohr-Coulomb	400	30
Bedrock		115	Mohr-Coulomb	540	36
Alluvium		110	Mohr-Coulomb	150	30

		Project: BG 21898 HARVARD WESTLAKE SECTION 3	
Analysis Description: CALCULATE THE MINIMUM REQUIRED EFP APPLIED TO SOIL NAIL WALLS TO ACHIEVE FS=1.5			
Drawn By: R. ZWEIGLER	Scale: 1:233	Company: BYER GEOTECHNICAL, INC.	File Name: 21898 Section 3 ver5 efp.slm
Date: 2/7/2014, 3:00:17 PM			

BG 21898 HARVARD WESTLAKE SECTION 3

CALCULATE THE MINIMUM REQUIRED EFP APPLIED TO THE FACE OF THE PROPOSED SOIL NAIL CONFIGURATION TO ACHIEVE A FACTOR OF SAFETY OF 1.0 UNDER SEISMIC LOADING.
 NOTE: THE SEARCH WAS LIMITED TO THE UPSLOPE DISTANCE RESULTING IN THE MOST CRITICAL FAILURE UNDER STATIC CONDITIONS.

THE RESULTS INDICATE THAT AN EFP OF 20 PCF WILL ACHIEVE A FACTOR OF SAFETY IN EXCESS OF 1.0.



DRS Section 3

1.037

EFP = 20 PCF

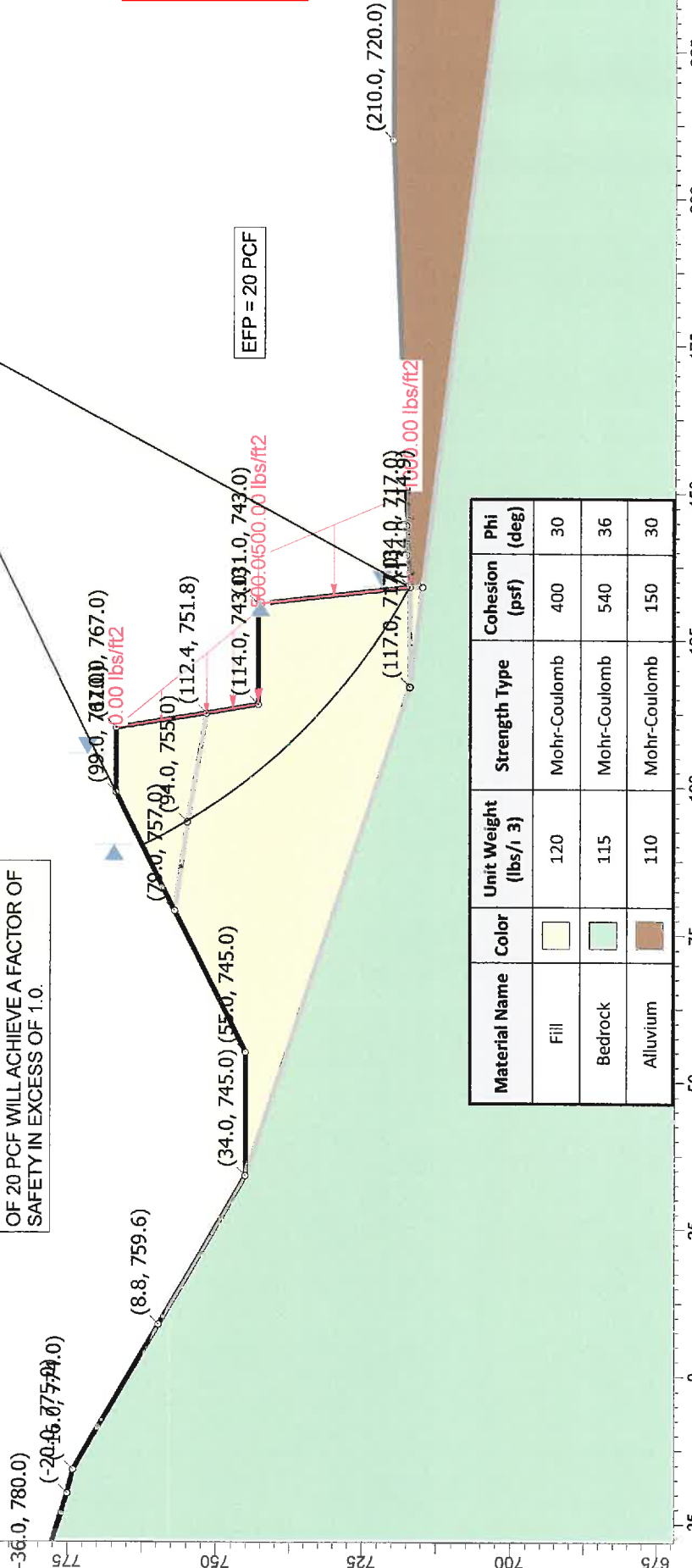

BYER GEOTECHNICAL INC.

Project: BG 21898 HARVARD WESTLAKE SECTION 3

Analysis Description: CALCULATE THE MINIMUM REQUIRED EFP APPLIED TO SOIL NAIL WALLS TO ACHIEVE FS=1.0 (SEISMIC)

Drawn By: R. ZWEIFLER Scale: 1:320 Company: BYER GEOTECHNICAL, INC.

Date: 2/7/2014, 3:00:17 PM File Name: 21898 Section 3 ver5 efp EQ.slim

SLIPINTERPRET 6.035

DRS Section 3

BG 21898 HARVARD WESTLAKE SECTION 3

CALCULATE THE MINIMUM REQUIRED EFP TO GENERATE A FACTOR OF SAFETY OF 1.5, APPLIED SO AS TO REPRESENT THE MASS OF EARTH CONSISTING OF A SOIL NAIL RETAINING WALL.

THE RESULTS INDICATE THAT AN EFP OF 21 PCF WILL ACHIEVE A FACTOR OF SAFETY OF GREATER THAN 1.5.

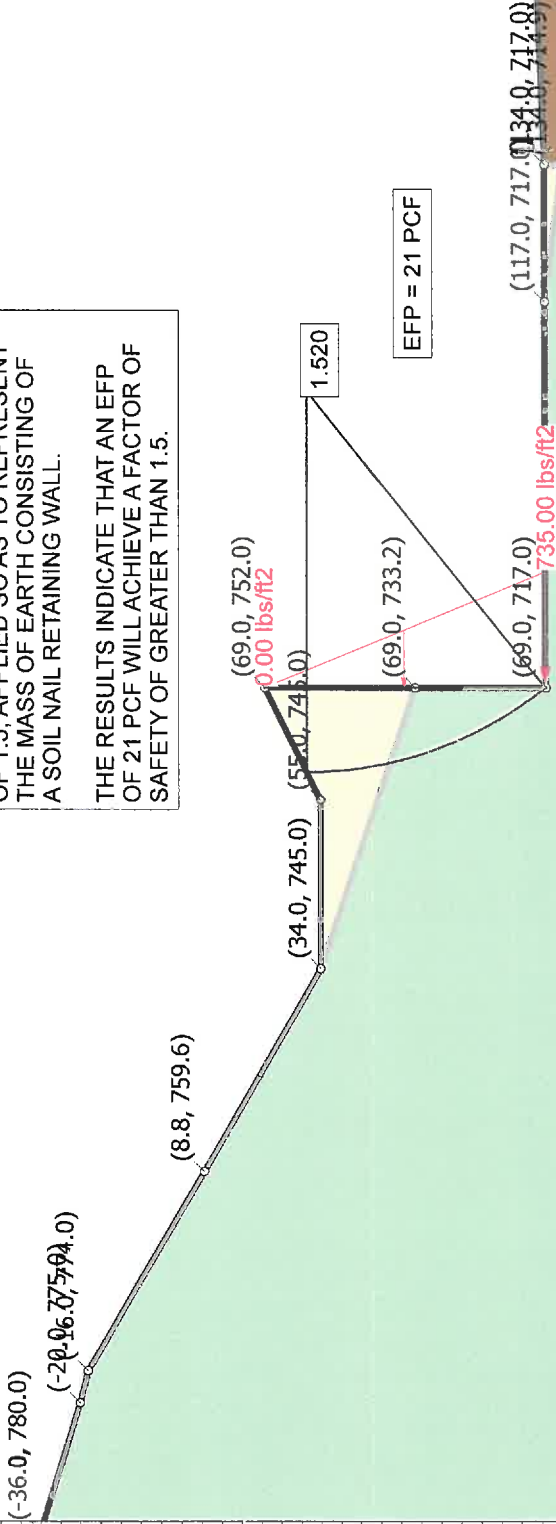

Material Name	Color	Unit Weight (lbs/ft ³)	Strength Type	Cohesion (psf)	Phi (deg)
Fill	[Yellow Box]	120	Mohr-Coulomb	400	30
Bedrock	[Green Box]	115	Mohr-Coulomb	540	36
Alluvium	[Brown Box]	110	Mohr-Coulomb	150	30

BYER GEOTECHNICAL INC.

Project: **BG 21898 HARVARD WESTLAKE SECTION 3**

Analysis Description: **CALCULATE THE MINIMUM REQUIRED EFP TO REPRESENT SOIL NAIL EARTH BLOCK**

Drawn By: **R. ZWEIGLER** Scale: **1:288** Company: **BYER GEOTECHNICAL, INC.**

Date: **5/18/2015** File Name: **21898 Section 3 efp on back of soil nail wall VER2.slim**

104

SLIDEINTERPRET 6.035

BG 21898 HARVARD WESTLAKE SECTION 3

CALCULATE THE MINIMUM REQUIRED EFP TO GENERATE A FACTOR OF SAFETY OF 1.0 UNDER SEISMIC LOADING, APPLIED SO AS TO REPRESENT THE MASS OF EARTH CONSISTING OF A SOIL NAIL RETAINING WALL.

THE RESULTS INDICATE THAT AN EFP OF 21 PCF WILL ACHIEVE A FACTOR OF SAFETY OF GREATER THAN 1.0 UNDER SEISMIC LOADING.

DRS Section 3

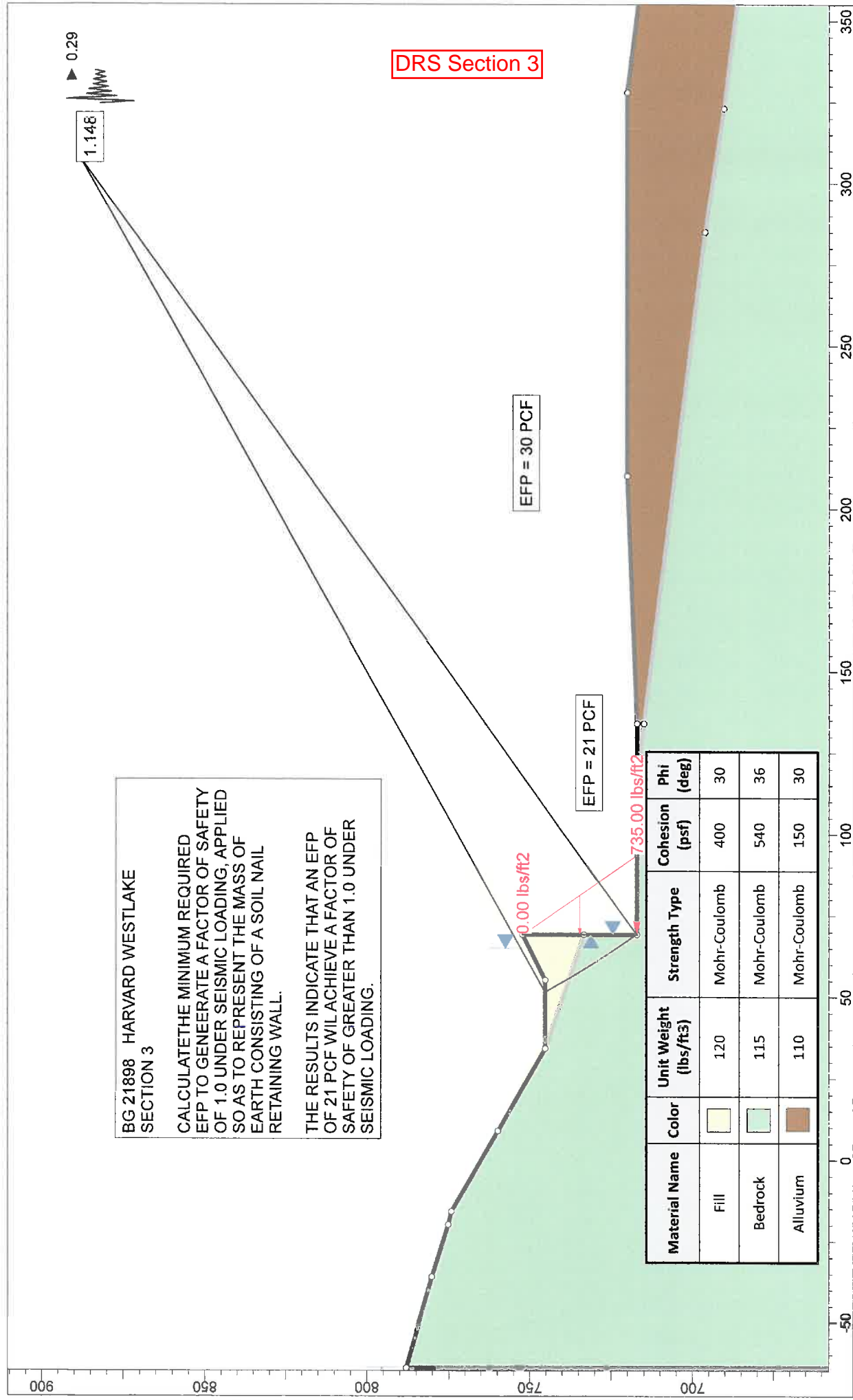

Material Name	Color	Unit Weight (lbs/ft ³)	Strength Type	Cohesion (psf)	Phi (deg)
Fill		120	Mohr-Coulomb	400	30
Bedrock		115	Mohr-Coulomb	540	36
Alluvium		110	Mohr-Coulomb	150	30

BYER GEOTECHNICAL INC.

Project: BG 21898 HARVARD WESTLAKE SECTION 3

Analysis Description: CALCULATE THE MINIMUM REQUIRED EFP TO REPRESENT SOIL NAIL EARTH BLOCK (SEISMIC)

Drawn By: R. ZWEIGLER **Scale:** 1:489 **Company:** BYER GEOTECHNICAL, INC.

Date: 5/18/2015 **File Name:** 21898 Section 3 efp on back of soil nail wall EQ.slim

SLIDEINTERPRET 6.035

DRS Section 2

BG 21898 HARVARD WESTLAKE SECTION 5
 CALCULATE THE MINIMUM REQUIRED EFP APPLIED TO THE FACE OF THE PROPOSED SOIL NAIL WALL CONFIGURATION TO ACHIEVE A FACTOR OF SAFETY OF 1.5.
 THE RESULTS INDICATE THAT AN EFP OF 85 POUNDS PER CUBIC FOOT WILL ACHIEVE A FACTOR OF SAFETY OF 1.5.

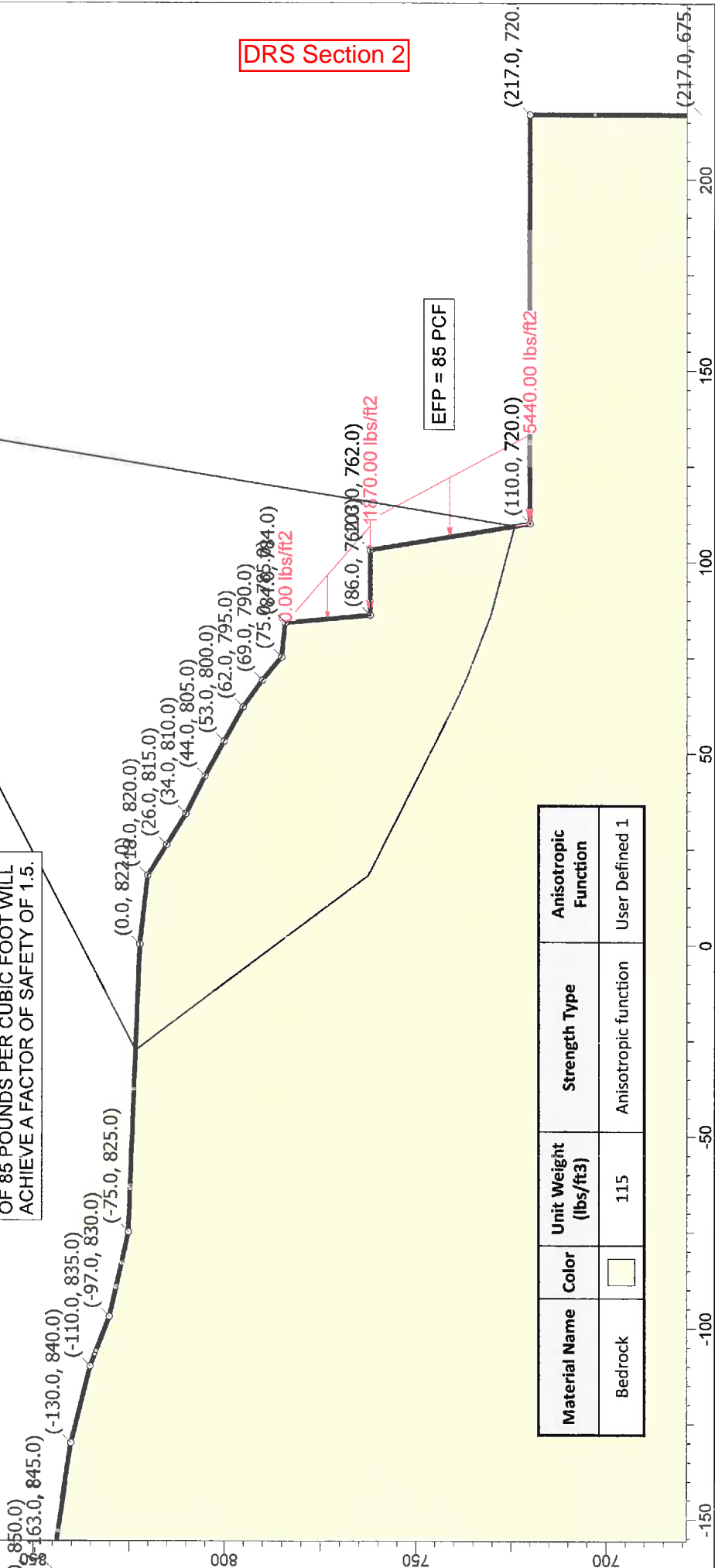

BYER GEOTECHNICAL INC.

118

SLIDEINTERPRET 6.035

Project: BG 21898 HARVARD-WESTLAKE SECTION 5

Analysis Description: CALCULATE THE MINIMUM REQUIRED EFP APPLIED TO SOIL NAIL WALLS TO ACHIEVE FS=1.5

Drawn By: R. ZWEIGLER Scale: 1:468 Company: BYER GEOTECHNICAL, INC.

Date: 5/18/15 File Name: 21898 Section 5 efp.slim

DRS Section 2

0.29

BG 21898 HARVARD WESTLAKE SECTION 5

CALCULATE THE MINIMUM REQUIRED EFP APPLIED TO THE FACE OF THE PROPOSED SOIL NAIL CONFIGURATION TO ACHIEVE A FACTOR OF SAFETY OF 1.0 UNDER SEISMIC LOADING.

NOTE: THE SEARCH WAS LIMITED TO THE UPSLOPE DISTANCE RESULTING IN THE MOST CRITICAL FAILURE UNDER STATIC CONDITIONS.

THE RESULTS INDICATE THAT AN EFP OF 110 PCF WILL ACHIEVE A FACTOR OF SAFETY IN EXCESS OF 1.0.

1.000

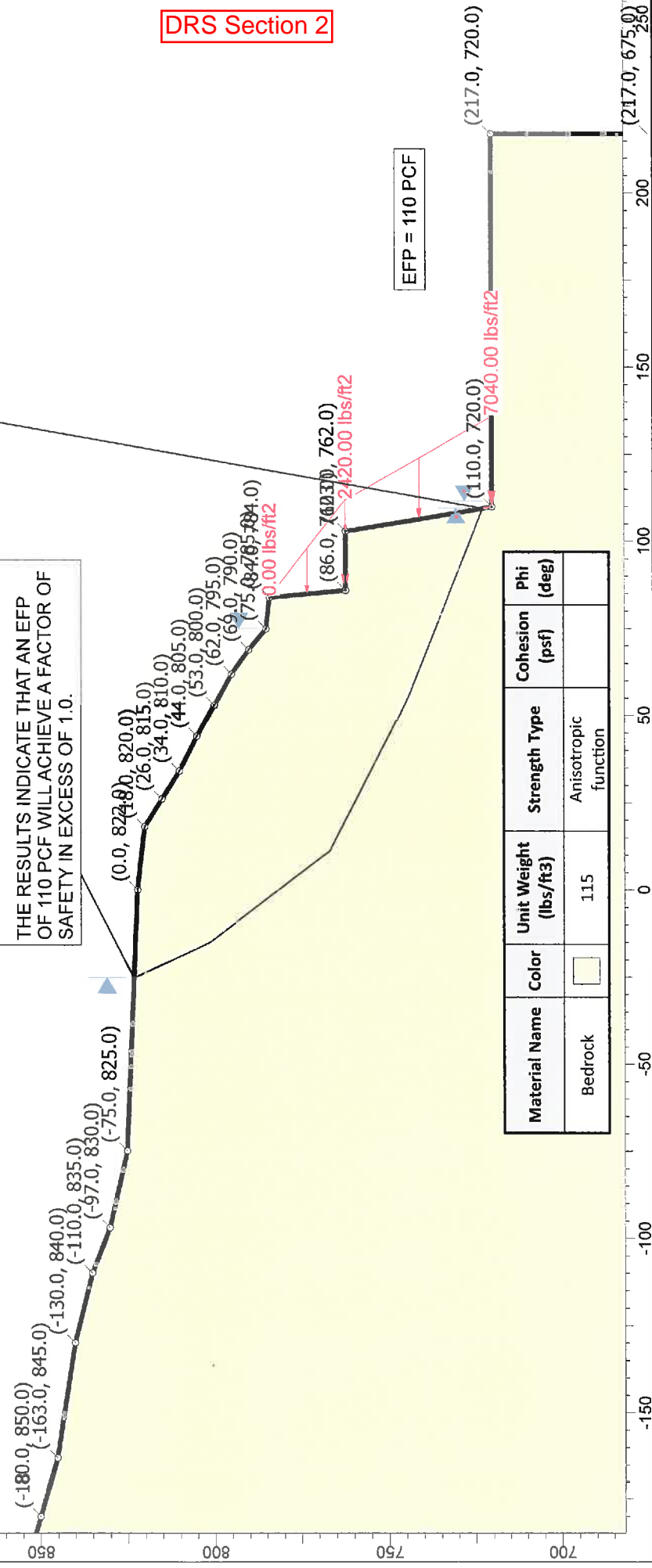

Material Name	Color	Unit Weight (lbs/ft³)	Strength Type	Cohesion (psf)	Phi (deg)
Bedrock	<input type="checkbox"/>	115	Anisotropic function		

BYER GEOTECHNICAL INC.		Project: BG 21898 HARVARD-WESTLAKE SECTION 5	
Analysis Description: CALCULATE THE MINIMUM REQUIRED EFP APPLIED TO SOIL NAIL WALLS TO ACHIEVE FS=1.0 (SEISMIC)			
Drawn By: R. ZWEIGLER	Scale: 1:520	Company: BYER GEOTECHNICAL, INC.	File Name: 21898 Section 5 efp EQ.slm
Date: 5/18/15			



DRS Section 2

BG 21898 HARVARD WESTLAKE SECTION 5

CALCULATE THE MINIMUM REQUIRED EFP TO GENERATE A FACTOR OF SAFETY OF 1.5 APPLIED SO AS TO REPRESENT THE MASS OF EARTH CONSISTING OF A SOIL NAIL WALL.

THE RESULTS INDICATE THAT AN EFP OF 67 PCF WILL ACHIEVE A FACTOR OF SAFETY OF GREATER THAN 1.5.

1.513

EFP = 67 PCF

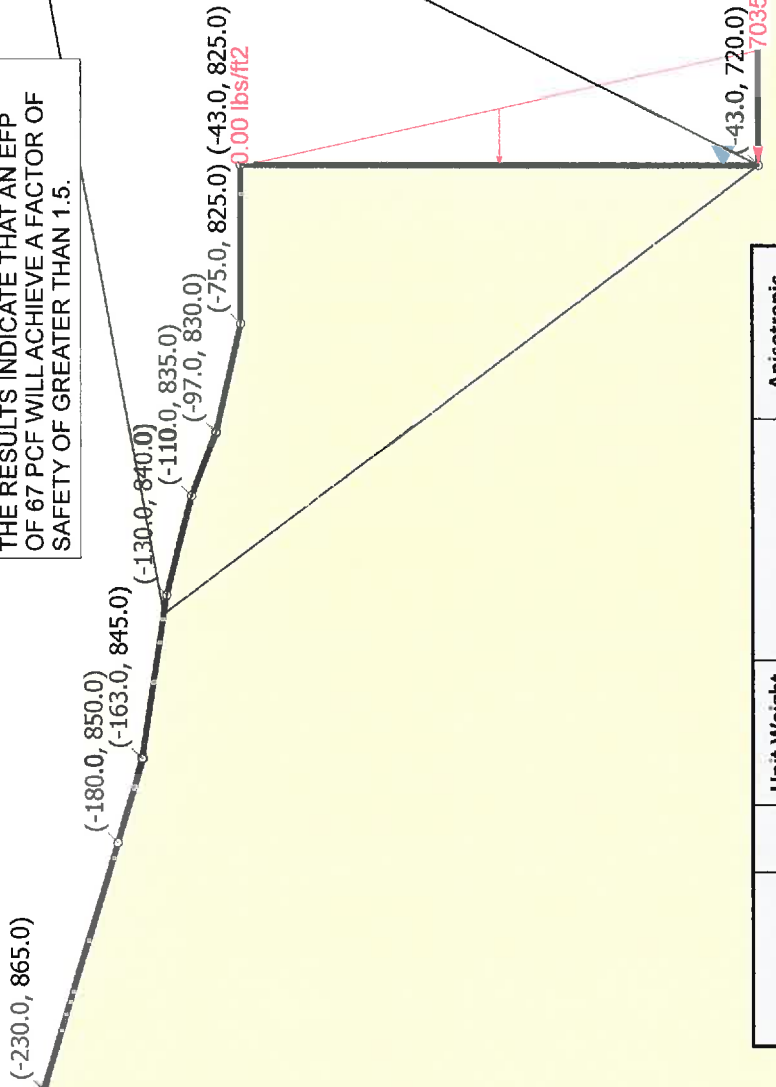

Material Name	Color	Unit Weight (lbs/ft3)	Strength Type	Anisotropic Function
Bedrock	<input type="checkbox"/>	115	Anisotropic function	User Defined 1

Project: BG 21898 HARVARD-WESTLAKE SECTION 5

Analysis Description: CALCULATE THE MINIMUM REQUIRED EFP TO REPRESENT THE SOIL NAIL EARTH BLOCK

Drawn By: R. ZWEIGLER
Scale: 1:468
Company: BYER GEOTECHNICAL, INC.

Date: 5/18/15
File Name: 21898 Section 5 efp on back of soil nail wall.slim





DRS Section 2

BG 21898 HARVARD WESTLAKE SECTION 5

CALCULATE THE MINIMUM REQUIRED EFP APPLIED TO THE FACE OF THE PROPOSED SOIL NAIL CONFIGURATION TO ACHIEVE A FACTOR OF SAFETY OF 1.0 UNDER SEISMIC LOADING.
 NOTE: THE SEARCH WAS LIMITED TO THE UPSLOPE DISTANCE RESULTING IN THE MOST CRITICAL FAILURE UNDER STATIC CONDITIONS.

THE RESULTS INDICATE THAT AN EFP OF 75 PCF WILL ACHIEVE A FACTOR OF SAFETY IN EXCESS OF 1.0.

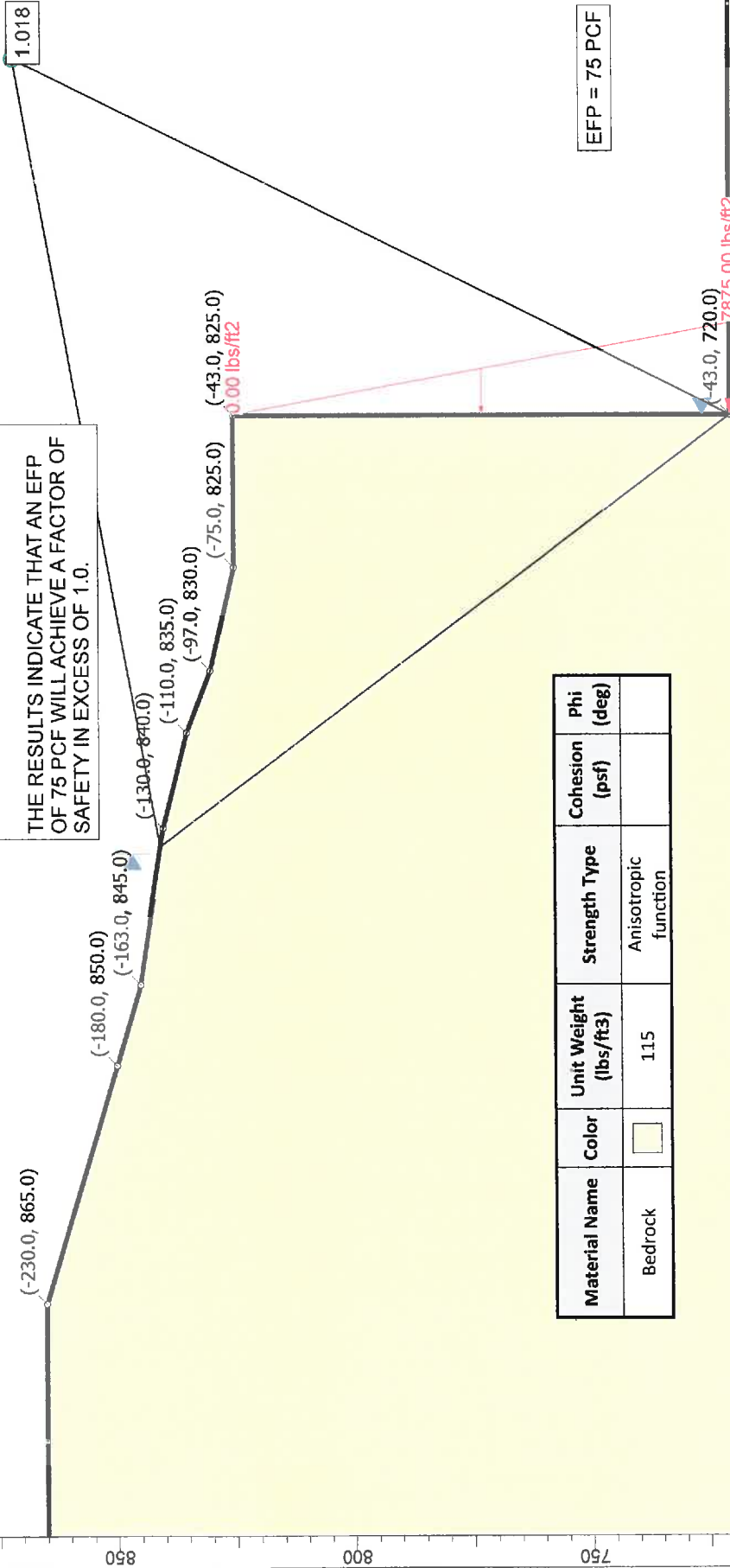

Material Name	Color	Unit Weight (lbs/ft ³)	Strength Type	Cohesion (psf)	Phi (deg)
Bedrock	□	115	Anisotropic function		

BYER GEOTECHNICAL INC.

Project BG 21898 HARVARD-WESTLAKE SECTION 5

Analysis Description CALCULATE THE MINIMUM REQUIRED EFP TO REPRESENT THE SOIL NAIL EARTH BLOCK (SEISMIC)

Drawn By R. ZWEIGLER **Scale** 1:421 **Company** BYER GEOTECHNICAL, INC.

Date 5/18/15 **File Name** 21898 Section 5 efp on back of soil nail wall EQ.slim

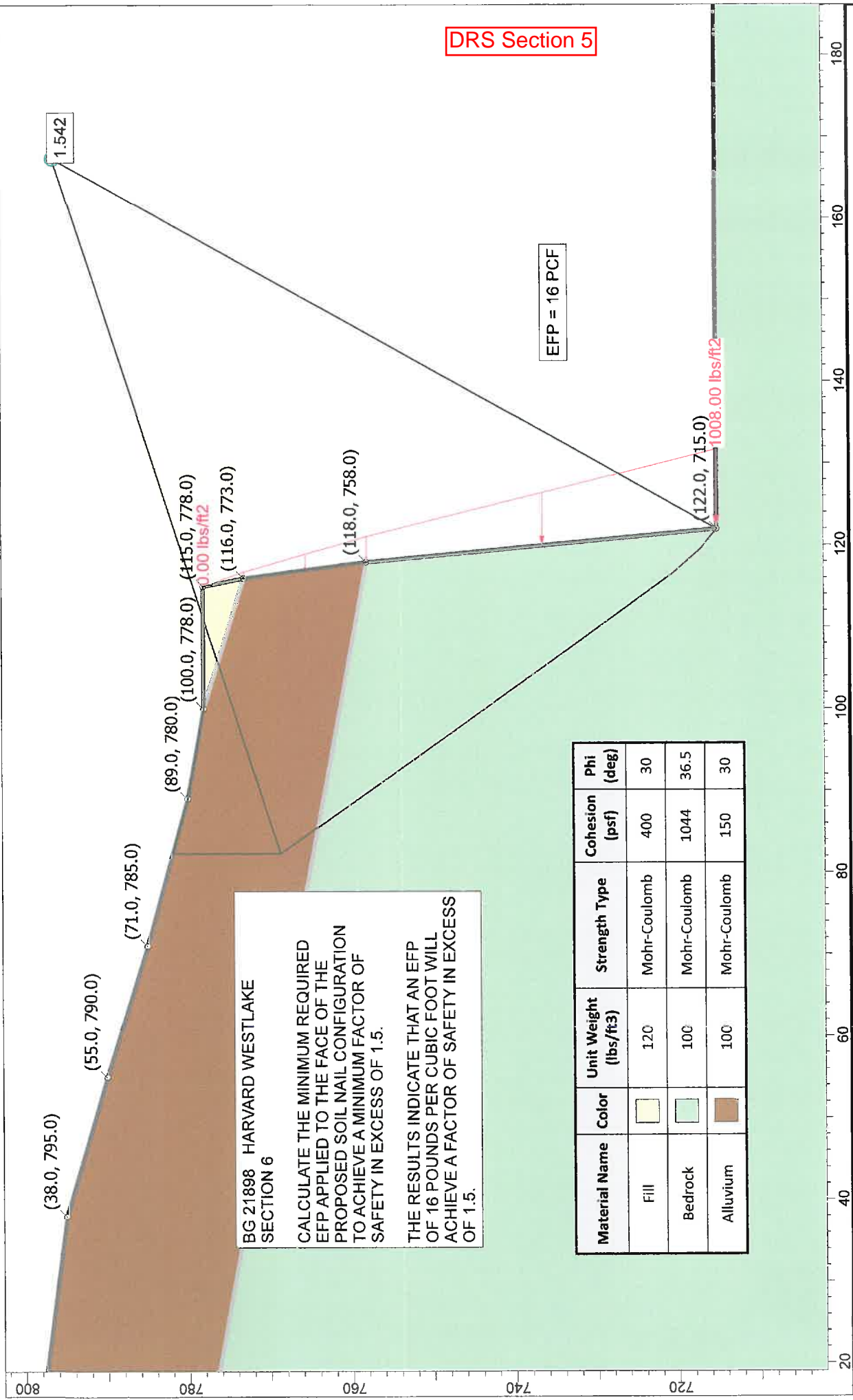

BG 21898 HARVARD WESTLAKE SECTION 6

CALCULATE THE MINIMUM REQUIRED EFP APPLIED TO THE FACE OF THE PROPOSED SOIL NAIL CONFIGURATION TO ACHIEVE A MINIMUM FACTOR OF SAFETY IN EXCESS OF 1.5.

THE RESULTS INDICATE THAT AN EFP OF 16 POUNDS PER CUBIC FOOT WILL ACHIEVE A FACTOR OF SAFETY IN EXCESS OF 1.5.

Material Name	Color	Unit Weight (lbs/ft3)	Strength Type	Cohesion (psf)	Phi (deg)
Fill		120	Mohr-Coulomb	400	30
Bedrock		100	Mohr-Coulomb	1044	36.5
Alluvium		100	Mohr-Coulomb	150	30

144

BYER GEOTECHNICAL INC.

Project: BG 21898 HARVARD WESTLAKE SECTION 6

Analysis Description: CALCULATE THE MINIMUM REQUIRED EFP APPLIED TO SOIL NAIL WALLS TO ACHIEVE FS=1.5

Drawn By: R. ZWEIGLER Scale: 1:195 Company: BYER GEOTECHNICAL, INC.

Date: 5/18/15 File Name: 21898 Section 6 ver2 efp.slm

SLIDEINTERPRET 6.035

BG 21898 HARVARD WESTLAKE
SECTION 6

CALCULATE THE MINIMUM REQUIRED EFP APPLIED TO THE FACE OF THE PROPOSED SOIL NAIL CONFIGURATION TO ACHIEVE A FACTOR OF SAFETY OF 1.0 UNDER SEISMIC LOADING.

THE RESULTS INDICATE THAT AN EFP OF 16 PCF WILL ACHIEVE A FACTOR OF SAFETY IN EXCESS OF 1.0.

DRS Section 5



1.351

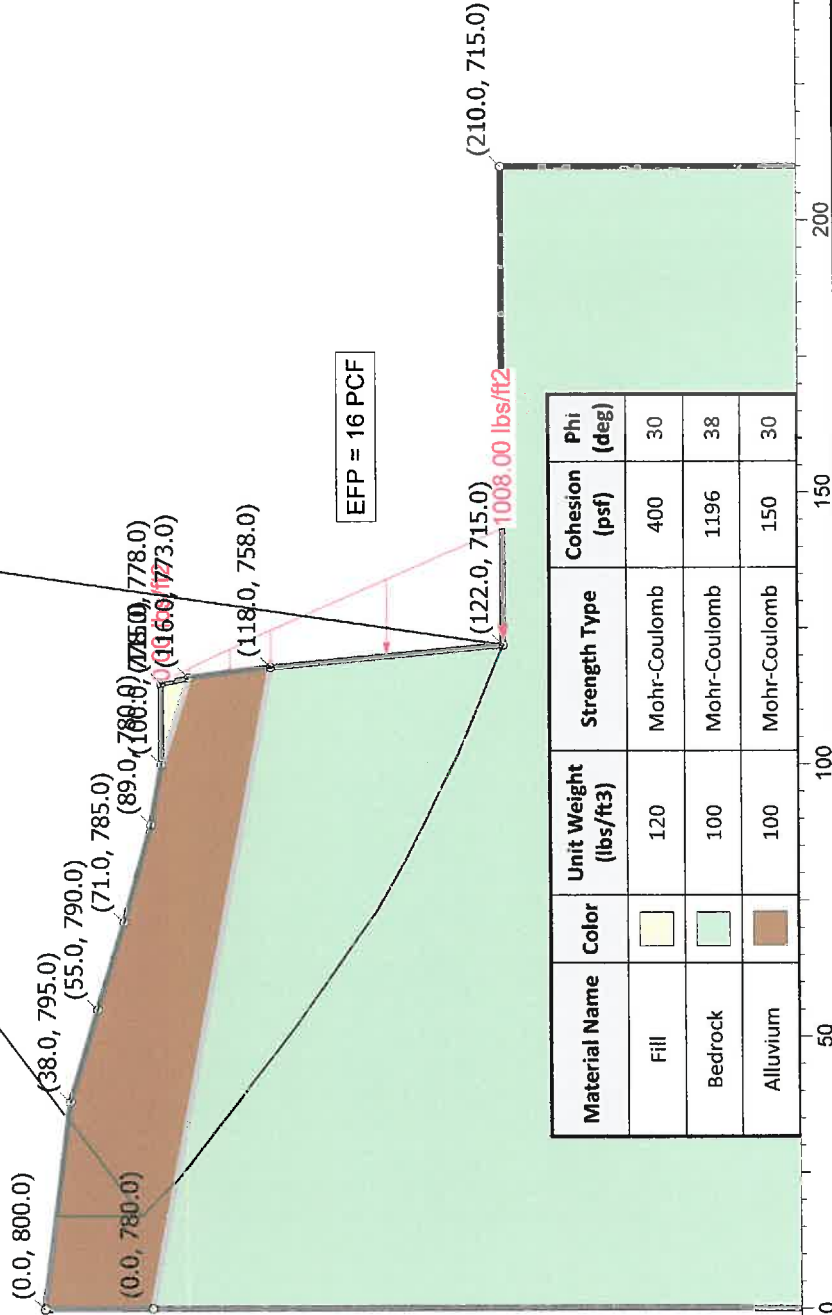

Material Name	Color	Unit Weight (lbs/ft ³)	Strength Type	Cohesion (psf)	Phi (deg)
Fill		120	Mohr-Coulomb	400	30
Bedrock		100	Mohr-Coulomb	1196	38
Alluvium		100	Mohr-Coulomb	150	30

Project
BG 21898 HARVARD WESTLAKE SECTION 6

Analysis Description	CALCULATE THE MINIMUM REQUIRED EFP APPLIED TO SOIL NAIL WALLS TO ACHIEVE FS=1.0 (SEISMIC)		
Drawn By	R. ZWEIGLER	Scale	1:425
Date	5/18/15	Company	BYER GEOTECHNICAL, INC.
		File Name	21898 Section 6 ver2 efp EQ.slm

BYER
GEOTECHNICAL
INC.





DRS Section 5

BG 21898 HARVARD WESTLAKE SECTION 6
 CALCULATE THE MINIMUM REQUIRED EFP TO GENERATE A FACTOR OF SAFETY OF 1.5, APPLIED SO AS TO REPRESENT THE MASS OF EARTH CONSISTING OF A SOIL NAIL WALL.
 THE RESULTS INDICATE THAT AN EFP OF 25 PCF WILL ACHIEVE A FACTOR OF SAFETY OF 1.511.

EFP = 25 PCF

0.00 lbs/ft²

1637.50 lbs/ft²

Material Name	Color	Unit Weight (lbs/ft ³)	Strength Type	Cohesion (psf)	Phi (deg)	Water Surface	Ru
Bedrock		100	Mohr-Coulomb	1044	36.5	None	0
Alluvium		100	Mohr-Coulomb	150	30	None	0

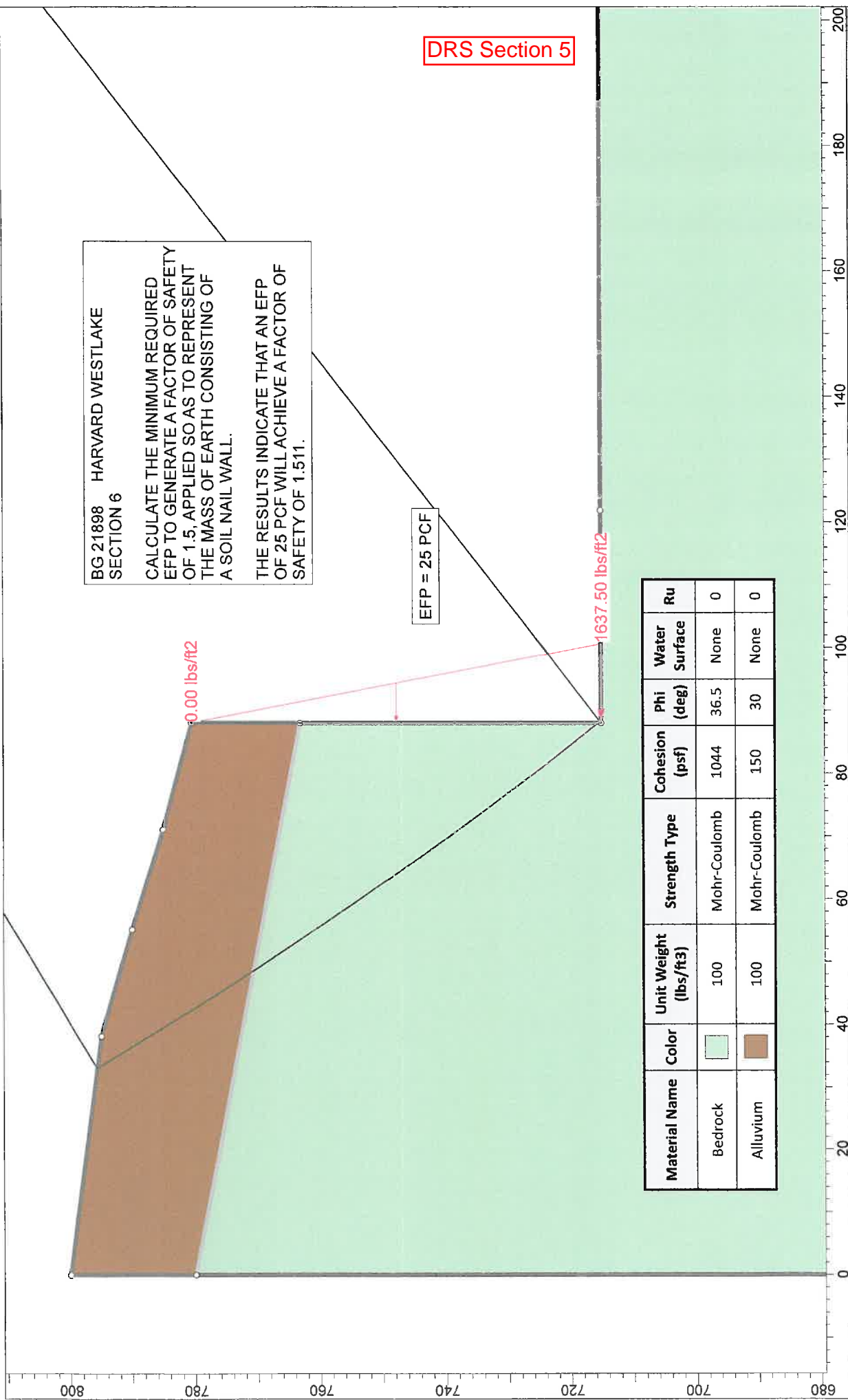

BG 21898 HARVARD WESTLAKE SECTION 6

CALCULATE THE MINIMUM REQUIRED EFP TO REPRESENT SOIL NAIL EARTH BLOCK

Project
Company

Analysis Description
BYER GEOTECHNICAL, INC.

Drawn By
Scale

R. ZWEIGLER
1:254

Date
File Name

5/18/15
21898 Section 6 efp on back of soil nail wall.slm



**BYER
GEOTECHNICAL
INC.**

SLIDEINTERPRET 6.035

0.29

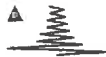

DRS Section 5

BG 21898 HARVARD WESTLAKE SECTION 6

CALCULATE THE MINIMUM REQUIRED EFP APPLIED TO THE FACE OF THE PROPOSED SOIL NAIL CONFIGURATION TO ACHIEVE A FACTOR OF SAFETY OF 1.0 UNDER SEISMIC LOADING.

THE RESULTS INDICATE THAT AN EFP OF 25 PCF WILL ACHIEVE A FACTOR OF SAFETY OF 1.086.

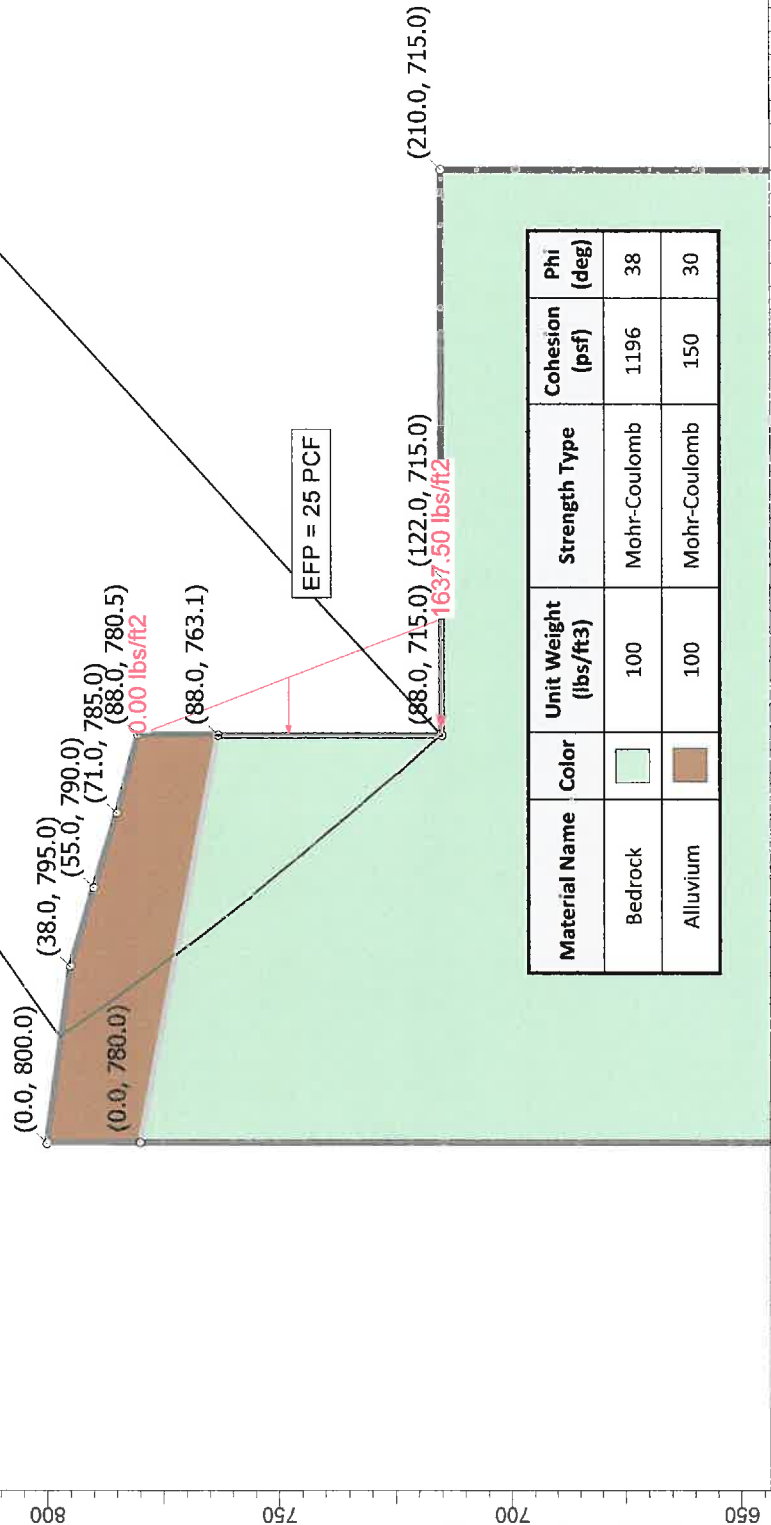

Project: BG 21898 HARVARD WESTLAKE SECTION 6

Analysis Description		CALCULATE THE MINIMUM REQUIRED EFP TO REPRESENT SOIL NAIL EARTH BLOCK (SEISMIC)	
Drawn By	R. ZWEIGLER	Scale	1:499
Date	5/18/15	Company	BYER GEOTECHNICAL, INC.
		File Name	21898 Section 6 efp on back of soil nail wall EQ.slim

BYER
GEOTECHNICAL
INC.



Pullout Capacity of Soil Nails Beyond Active Wedge Check

Sliding Block Check

Bearing Capacity (from overturning) Check



Engineering

Case: DRS2 BG5 bN ST - STATIC

Date: 7/16/2015

LADBS Check for soil nail wall to support EFP from Geotech

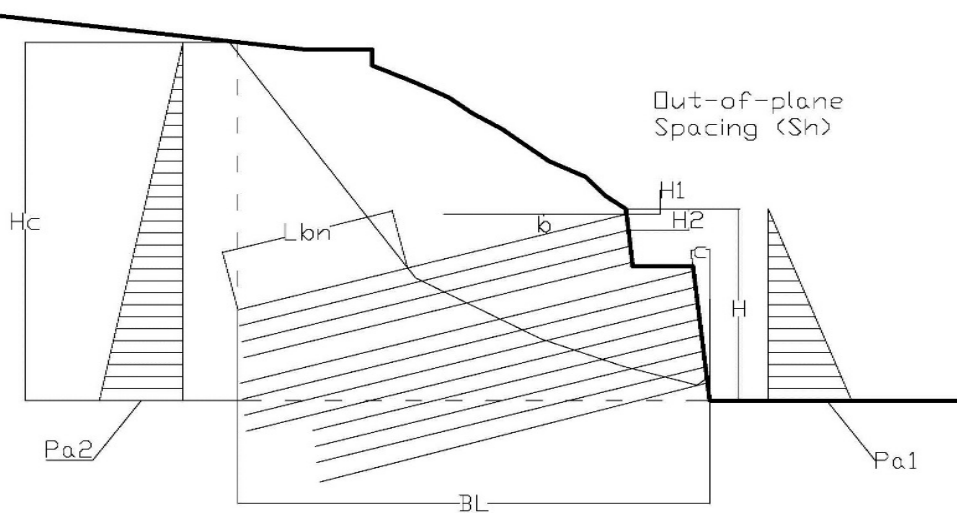

Soil Nail Wall Height	H =	60 ft	Nail Vert. Spacing	H2, H3...=	5 ft
No Rows Nails	n =	12	Nail Horz. Spacing	Sh =	4 ft
Depth to top nail	H1 =	1.5 ft	Wall face angle	c =	7 deg
Allowable bond stress (Bedrock)	BS1 =	8 psi	Soil Nail dia	d =	8 in

Effective EFP (from Geotech) Pa1 = 85 pcf => Total EFP over Sh = $(Pa1 \cdot H^2) / 2 \cdot Sh =$ **612 kip**

Soil Nail Row	Hn	Nail Length ft	Soil Nail Incln. Angle (b) deg	Lbn ft	Lbn soil type	Static Capacity Lbns kip
1	1.5	120	15	52.5	Bedrock	122.4
2	6.5	120	15	56.2	Bedrock	131.0
3	11.5	120	15	62.5	Bedrock	145.7
4	16.5	120	15	68.9	Bedrock	160.6
5	21.5	140	15	80.2	Bedrock	186.9
6	26.5	140	15	86.5	Bedrock	201.6
7	31.5	140	15	93.1	Bedrock	217.0
8	36.5	140	15	101.3	Bedrock	236.1
9	41.5	120	15	89.4	Bedrock	208.3
10	46.5	120	15	97.9	Bedrock	228.2
11	51.5	120	15	107.4	Bedrock	250.3
12	56.5	120	15	120.0	Bedrock	279.7

Total Capacity = **2367.6** kip

Total capacity / Total EFP: $FS = \sum Lbns / Psh$ Factor of Safety = **3.87 > 1.0 - OK**

Case: DRS2 BG5 bN ST - STATIC

Date: 7/16/2015

Sliding Check:

Sliding failure may occur when additional lateral earth pressures, mobilized by the excavation, exceed the sliding resistance along the base. Soil nail wall system is modeled as a rigid block against which the lateral earth forces are applied behind the retained soil.

Height at the cut-section, $H_c =$	105 ft	<i>(ht. from top to bottom of wall at the failure surface)</i>
Dist. of failure surface from wall, $B_f =$	141.1 ft	<i>(horz distance to failure surface from bottom of wall)</i>
E.F.P for Sliding, $Pa_2 =$	67 pcf	<i>(from geotech)</i>
Unit weight of the soil behind wall, $\gamma =$	115 pcf	
Soil cohesion strength, $c_b =$	510 psf	
Coefficient of friction, $\tan \Phi =$	0.5	
Weight of soil block, $W =$	1,339 kip/ft	<i>$(H+H_c)/2 \cdot BL \cdot \gamma$</i>
Driving Force, $P =$	369 kip/ft	<i>$(1/2 \cdot Pa_2 \cdot H_c^2)$</i>
Resisting Force =	741 kip/ft	<i>$(c_b \cdot BL + (W + Pa_2 \cdot \sin \beta) \cdot \tan \Phi)$; $\beta = 0$, conservatively)</i>
Factor of Safety =	2.01	

>1.0 - OK

Bearing Capacity (due to overturning) Check:

$y = H_c/3 =$	35.0 ft	
Overturning Moment, $M =$	12,915 ft-kip/ft	<i>$(P \cdot y)$</i>
$X_0 =$	60.9 ft	<i>$(W \cdot B/2 - M)/W$</i>
Check for eccentricity: $e = B_f/2 - X_0 =$	9.6 ft	$B_f/6 = 23.5$ ft $e < B/6$, OK
$B' =$	121.8 ft	
$q_{max} =$	10,990 psf	
$q_{ult} =$	14,000 psf	$q_{max} \leq q_{ult}$, OK

Per FHWA0-IF-03-017 Manual Section 5.4.4 - Bearing Capacity (Heave) Analysis per equation 5.14 is not required as soft soil is not present below the soil nail wall. Equivalent bearing capacity analyses has effectively been performed in the slope stability analysis that considers deep-seated failure surfaces below the toe of the wall.



Engineering

Case: DRS2 BG5 bN ST - SEISMIC

Date: 7/16/2015

LADBS Check for soil nail wall to support EFP from Geotech

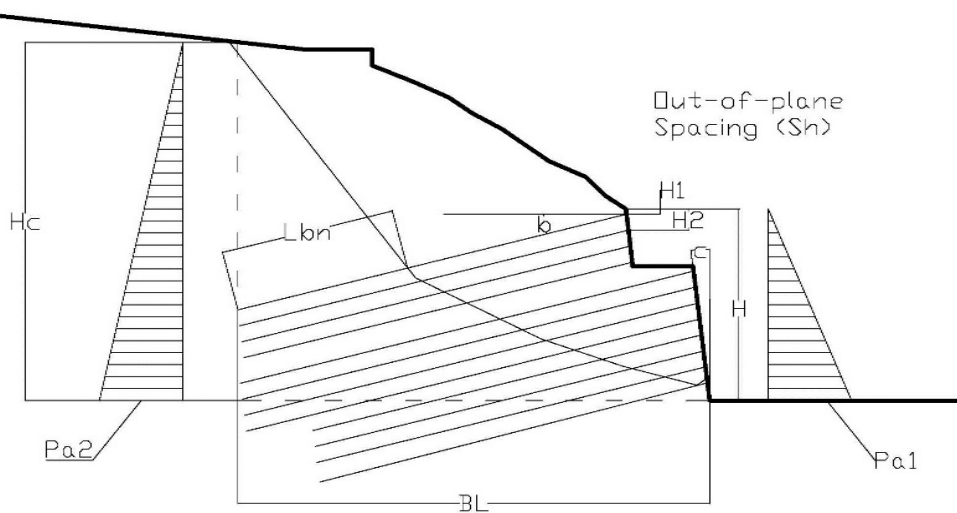

Soil Nail Wall Height	H =	60 ft	Nail Vert. Spacing	H2, H3...=	5 ft
No Rows Nails	n =	12	Nail Horz. Spacing	Sh =	4 ft
Depth to top nail	H1 =	1.5 ft	Wall face angle	c =	7 deg
Allowable bond stress (Bedrock)	BS1 =	10.7 psi	Soil Nail dia	d =	8 in

Effective EFP (from Geotech) Pa1 = 110 pcf ⇒ Total EFP over Sh = $(Pa1 \cdot H^2) / 2 \cdot Sh = 792$ kip

Soil Nail Row	Hn	Nail Length ft	Soil Nail Incln. Angle (b) deg	Lbn ft	Lbn soil type	Static Capacity Lbns kip
1	1.5	120	15	52.5	Bedrock	163.6
2	6.5	120	15	56.2	Bedrock	175.2
3	11.5	120	15	62.5	Bedrock	194.8
4	16.5	120	15	68.9	Bedrock	214.8
5	21.5	140	15	80.2	Bedrock	250.0
6	26.5	140	15	86.5	Bedrock	269.6
7	31.5	140	15	93.1	Bedrock	290.2
8	36.5	140	15	101.3	Bedrock	315.8
9	41.5	120	15	89.4	Bedrock	278.7
10	46.5	120	15	97.9	Bedrock	305.2
11	51.5	120	15	107.4	Bedrock	334.8
12	56.5	120	15	120.0	Bedrock	374.1

Total Capacity = **3166.6** kip

Total capacity / Total EFP: $FS = \sum Lbns / Psh$ Factor of Safety = 4.00 > 1.0 - OK

Case: DRS2 BG5 bN ST - SEISMIC

Date: 7/16/2015

Sliding Check:

Sliding failure may occur when additional lateral earth pressures, mobilized by the excavation, exceed the sliding resistance along the base. Soil nail wall system is modeled as a rigid block against which the lateral earth forces are applied behind the retained soil.

Height at the cut-section, $H_c =$	105 ft	<i>(ht. from top to bottom of wall at the failure surface)</i>
Dist. of failure surface from wall, $B_f =$	141.1 ft	<i>(horz distance to failure surface from bottom of wall)</i>
E.F.P for Sliding, $Pa_2 =$	75 pcf	<i>(from geotech)</i>
Unit weight of the soil behind wall, $\gamma =$	115 pcf	
Soil cohesion strength, $c_b =$	510 psf	
Coefficient of friction, $\tan \Phi =$	0.5	
Weight of soil block, $W =$	1,339 kip/ft	<i>$(H+H_c)/2 \cdot BL \cdot \gamma$</i>
Driving Force, $P =$	413 kip/ft	<i>$(1/2 \cdot Pa_2 \cdot H_c^2)$</i>
Resisting Force =	741 kip/ft	<i>$(c_b \cdot BL + (W + Pa_2 \cdot \sin \beta) \cdot \tan \Phi)$; $\beta = 0$, conservatively)</i>
Factor of Safety =	1.79	

>1.0 - OK

Bearing Capacity (due to overturning) Check:

$y = H_c/3 =$	35.0 ft	
Overturning Moment, $M =$	14,455 ft-kip/ft	<i>$(P \cdot y)$</i>
$X_0 =$	59.8 ft	<i>$(W \cdot B/2 - M)/W$</i>
Check for eccentricity: $e = B_f/2 - X_0 =$	10.8 ft	$B_f/6 = 23.5$ ft $e < B/6$, OK
$B' =$	119.5 ft	
$q_{max} =$	11,202 psf	
$q_{ult} =$	14,000 psf	$q_{max} \leq q_{ult}$, OK

Per FHWA0-IF-03-017 Manual Ssection 5.4.4 - Bearing Capacity (Heave) Analysis per equation 5.14 is not required as soft soil is not present below the soil nail wall. Equivalent bearing capacity analyses has effectively been performed in the slope stability analysis that considers deep-seated failure surfaces below the toe of the wall.



Case: DRS3 BG3 dN ST - STATIC

Engineering

Date: 7/16/2015

LADBS Check for soil nail wall to support EFP from Geotech

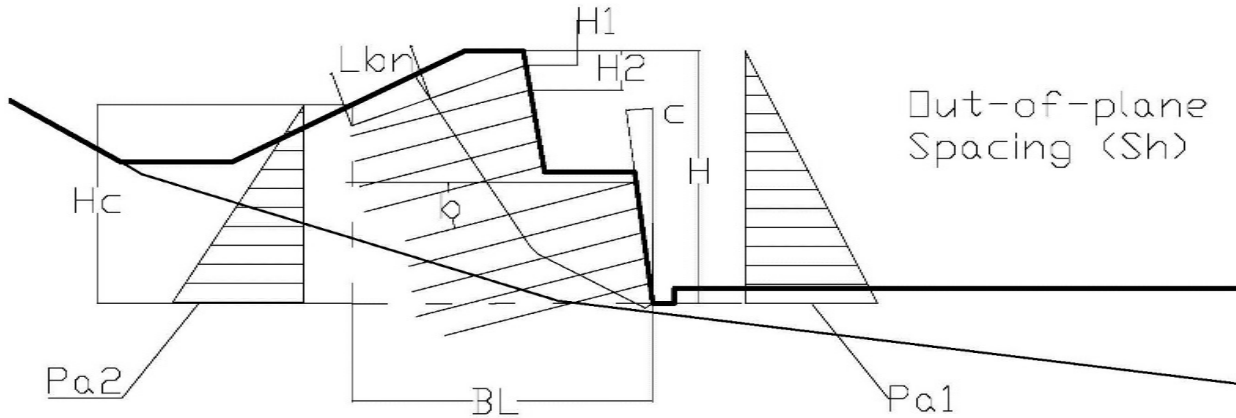

Soil Nail Wall Height	H =	50 ft	Nail Vert. Spacing	H2, H3...=	5 ft
No Rows Nails	n =	10	Nail Horz. Spacing	Sh =	5 ft
Depth to top nail	H1 =	3 ft	Wall face angle	c =	7 deg
Allowable bond stress (Alluvium)	BS1 =	5 psi	Soil Nail dia	d =	6 in
Allowable bond stress (Bedrock)	BS2 =	8 psi			

Effective EFP (from Geotech) Pa = 30 pcf => Total EFP over Sh = $(Pa \cdot H^2) / 2 \cdot Sh = 187.5$ kip

Soil Nail Row	Hn	Nail Length	Soil Nail Incln. Angle (b)	Lbn	Lbn soil type	Static Capacity Lbns
		ft	deg	ft		kip
1	3	35	20	15.8	Alluvium	16.8
2	8	45	15	17.4	Alluvium	19.0
3	13	40	15	19.5	Alluvium	21.3
4	18	40	15	21.6	Alluvium	23.6
5	23	35	15	23.7	Alluvium	25.9
6	28	35	15	20.1	Alluvium	22.0
7	33	35	15	22.4	Alluvium	24.5
8	38	35	15	25.9	Bedrock	45.3
9	43	35	15	32.0	Bedrock	55.9
10	48	35	15	33.0	Bedrock	57.7

Total Capacity = **311.9** kip

Total capacity / Total EFP: $FS = \sum Lbns / Psh$

Factor of Safety = 1.66 > 1.0 - OK

Case: DRS3 BG3 dN ST - STATIC

Date: 7/16/2015

Sliding Check:

Sliding failure may occur when additional lateral earth pressures, mobilized by the excavation, exceed the sliding resistance along the base. Soil nail wall system is modeled as a rigid block against which the lateral earth forces are applied behind the retained soil.

Height at the cut-section, $H_c =$	35 ft	<i>(height from top to bottom of wall at the failure surface)</i>
Dist. of failure surface from wall, $B_f =$	57 ft	<i>(horizontal distance to failure surface from bottom of wall)</i>
E.F.P for Sliding, $Pa_2 =$	21 pcf	<i>(from geotech)</i>
Unit weight of the soil behind wall, $Y =$	115 pcf	
Soil cohesion strength, $c_b =$	540 psf	
Coefficient of friction, $\tan \Phi =$	0.5	
Weight of soil block, $W =$	289 kip/ft	<i>$(H+H_c)/2 \cdot BL \cdot Y$</i>
Driving Force, $P =$	13 kip/ft	<i>$(1/2 \cdot Pa_2 \cdot H_c^2)$</i>
Resisting Force =	175 kip/ft	<i>$(c_b \cdot BL + (W + Pa_2 \cdot \sin \beta) \cdot \tan \Phi)$; $\beta = 0$, conservatively)</i>
Factor of Safety =	13.46	

>1.0 - OK

Bearing Capacity (due to overturning) Check:

$y = H_c/3 =$	11.7 ft	
Overturning Moment, $M =$	152 ft-kip/ft	<i>$(P \cdot y)$</i>
$X_0 =$	28.0 ft	<i>$(W \cdot B/2 - M)/W$</i>
Check for eccentricity: $e = B_f/2 - X_0 =$	0.5 ft	$B_f/6 = 9.5$ ft $e < B/6$, OK
$B' =$	55.9 ft	
$q_{max} =$	5,170 psf	
$q_{ult} =$	14,000 psf	$q_{max} \leq q_{ult}$, OK

Per FHWA0-IF-03-017 Manual Section 5.4.4 - Bearing Capacity (Heave) Analysis per equation 5.14 is not required as soft soil is not present below the soil nail wall. Equivalent bearing capacity analyses has effectively been performed in the slope stability analysis that considers deep-seated failure surfaces below the toe of the wall.

Case: DRS3 BG3 dN ST - SEISMIC

Engineering

Date: 7/16/2015

LADBS Check for soil nail wall to support EFP from Geotech

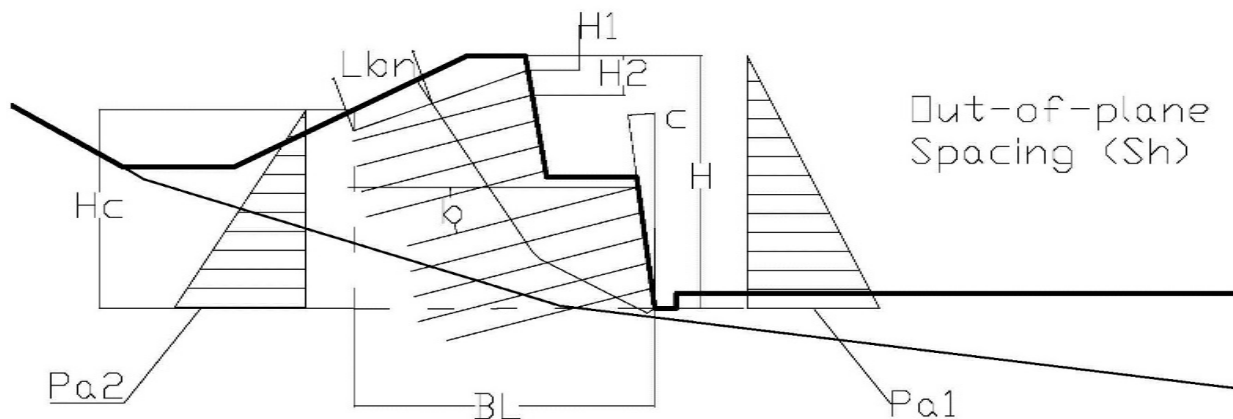

Soil Nail Wall Height	H =	50 ft	Nail Vert. Spacing	H2, H3...=	5 ft
No Rows Nails	n =	10	Nail Horz. Spacing	Sh =	5 ft
Depth to top nail	H1 =	3 ft	Wall face angle	c =	7 deg
Allowable bond stress (Alluvium)	BS1 =	6.7 psi	Soil Nail dia	d =	6 in
Allowable bond stress (Bedrock)	BS2 =	10.7 psi			

Effective EFP (from Geotech) Pa = 30 pcf => Total EFP over Sh = $(Pa \cdot H^2) / 2 \cdot Sh = 187.5$ kip

Soil Nail Row	Hn	Nail Length	Soil Nail Incln. Angle (b)	Lbn	Lbn soil type	Static Capacity Lbns
		ft	deg	ft		kip
1	3	35	20	15.8	Alluvium	22.5
2	8	45	15	17.4	Alluvium	25.5
3	13	40	15	19.5	Alluvium	28.5
4	18	40	15	21.6	Alluvium	31.6
5	23	35	15	23.7	Alluvium	34.7
6	28	35	15	20.1	Alluvium	29.4
7	33	35	15	22.4	Alluvium	32.8
8	38	35	15	25.9	Bedrock	60.5
9	43	35	15	32.0	Bedrock	74.8
10	48	35	15	33.0	Bedrock	77.1

Total Capacity = **417.6** kip

Total capacity / Total EFP: FS = $\sum Lbns / Psh$

Factor of Safety = 2.23 > 1.0 - OK

Case: DRS3 BG3 dN ST - SEISMIC

Date: 7/16/2015

Sliding Check:

Sliding failure may occur when additional lateral earth pressures, mobilized by the excavation, exceed the sliding resistance along the base. Soil nail wall system is modeled as a rigid block against which the lateral earth forces are applied behind the retained soil.

Height at the cut-section, $H_c =$	35 ft	<i>(height from top to bottom of wall at the failure surface)</i>
Dist. of failure surface from wall, $B_L =$	57 ft	<i>(horizontal distance to failure surface from bottom of wall)</i>
E.F.P for Sliding, $Pa_2 =$	21 pcf	<i>(from geotech)</i>
Unit weight of the soil behind wall, $Y =$	115 pcf	
Soil cohesion strength, $c_b =$	540 psf	
Coefficient of friction, $\tan \Phi =$	0.5	
Weight of soil block, $W =$	289 kip/ft	<i>$(H+H_c)/2 \cdot BL \cdot Y$</i>
Driving Force, $P =$	13 kip/ft	<i>$(1/2 \cdot Pa_2 \cdot H_c^2)$</i>
Resisting Force =	175 kip/ft	<i>$(c_b \cdot BL + (W + Pa_2 \cdot \sin \beta) \cdot \tan \Phi)$; $\beta = 0$, conservatively)</i>
Factor of Safety =	13.46	

>1.0 - OK

Bearing Capacity (due to overturning) Check:

$y = H_c/3 =$	11.7 ft	
Overturning Moment, $M =$	152 ft-kip/ft	<i>$(P \cdot y)$</i>
$X_0 =$	28.0 ft	<i>$(W \cdot B/2 - M)/W$</i>
Check for eccentricity: $e = B_L/2 - X_0 =$	0.5 ft	$B_L/6 = 9.5$ ft $e < B/6$, OK
$B' =$	55.9 ft	
$q_{max} =$	5,170 psf	
$q_{ult} =$	14,000 psf	$q_{max} \leq q_{ult}$, OK

Per FHWA0-IF-03-017 Manual Ssection 5.4.4 - Bearing Capacity (Heave) Analysis per equation 5.14 is not required as soft soil is not present below the soil nail wall. Equivalent bearing capacity analyses has effectively been performed in the slope stability analysis that considers deep-seated failure surfaces below the toe of the wall.

Case: DRS4 BG1 bN ST - STATIC

Date: 7/16/2015

LADBS Check for soil nail wall to support EFP from Geotech

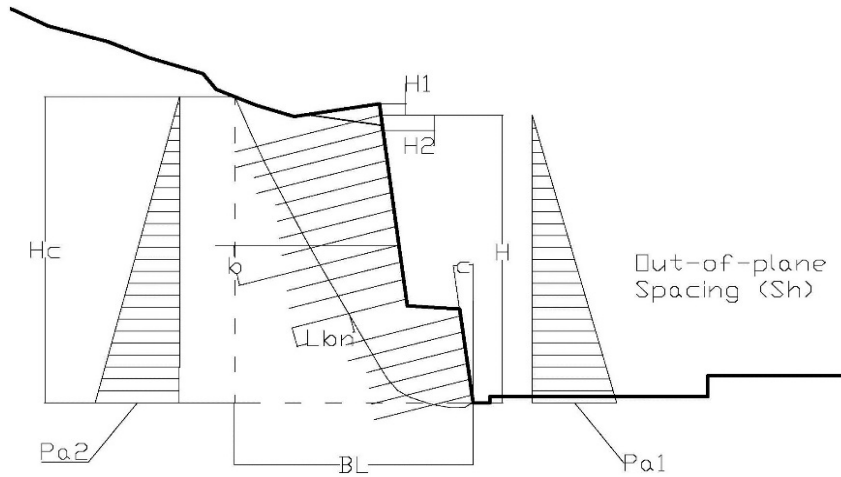

Soil Nail Wall Height	H =	90 ft	Nail Vert. Spacing	H2, H3...=	5 ft
No Rows Nails	n =	18	Nail Horz. Spacing	Sh =	5 ft
Depth to top nail	H1 =	2 ft	Wall face angle	c =	7 deg
Allowable bond stress (Bedrock)	BS1 =	8 psi	Soil Nail dia	d =	6 in
Effective EFP (from Geotech)	Pa =	10 pcf	=> Total EFP over Sh =	(Pa.H ²)/2 . Sh =	202.5 kip

Soil Nail Row	Hn	Nail Length ft	Soil Nail Incln. Angle (b) deg	Lbn ft	Lbn soil type	Static Capacity Lbns kip
1	2	45	15	6.8	Bedrock	11.9
2	7	45	15	8.4	Bedrock	14.7
3	12	40	15	4.9	Bedrock	8.6
4	17	40	15	6.6	Bedrock	11.5
5	22	35	15	3.3	Bedrock	5.8
6	27	35	15	5.0	Bedrock	8.7
7	32	35	15	6.9	Bedrock	12.1
8	37	35	15	8.7	Bedrock	15.2
9	42	35	15	10.9	Bedrock	19.1
10	47	35	15	12.9	Bedrock	22.5
11	52	35	15	15.0	Bedrock	26.2
12	57	35	15	17.3	Bedrock	30.2
13	62	35	15	5.6	Bedrock	9.8
14	67	35	15	7.5	Bedrock	13.1
15	72	30	15	4.4	Bedrock	7.7
16	77	30	15	6.6	Bedrock	11.5
17	82	30	15	10.6	Bedrock	18.5
18	87	30	15	18.3	Bedrock	32.0

Total Capacity = **279.1** kip

Total capacity / Total EFP: FS = $\sum \text{Lbns} / \text{Psh}$

Factor of Safety = 1.38 > 1.0 - OK

Case: DRS4 BG1 bN ST - STATIC

Date: 7/16/2015

Sliding Check:

Sliding failure may occur when additional lateral earth pressures, mobilized by the excavation, exceed the sliding resistance along the base. Soil nail wall system is modeled as a rigid block against which the lateral earth forces are applied behind the retained soil.

Height at the cut-section, $H_c =$	93.5 ft	<i>(height from top to bottom of wall at the failure surface)</i>
Dist. of failure surface from wall, $B_f =$	70.5 ft	<i>(horizontal distance to failure surface from bottom of wall)</i>
E.F.P for Sliding, $Pa_2 =$	30 pcf	<i>(from geotech)</i>
Unit weight of the soil behind wall, $Y =$	100 pcf	
Soil cohesion strength, $c_b =$	1044 psf	
Coefficient of friction, $\tan \Phi =$	0.5	
Weight of soil block, $W =$	647 kip/ft	<i>$(H+H_c)/2 \cdot BL \cdot Y$</i>
Driving Force, $P =$	131 kip/ft	<i>$(1/2 \cdot Pa_2 \cdot H_c^2)$</i>
Resisting Force =	397 kip/ft	<i>$(c_b \cdot BL + (W + Pa_2 \cdot \sin \beta) \cdot \tan \Phi)$; $\beta = 0$, conservatively)</i>
Factor of Safety =	3.03	

>1.0 - OK

Bearing Capacity (due to overturning) Check:

$y = H_c/3 =$	31.2 ft	
Overturning Moment, $M =$	4,083 ft-kip/ft	<i>$(P \cdot y)$</i>
$X_0 =$	28.9 ft	<i>$(W \cdot B/2 - M)/W$</i>
Check for eccentricity: $e = B_f/2 - X_0 =$	6.3 ft	$B_f/6 = 11.8$ ft $e < B/6$, OK
$B' =$	57.9 ft	
$q_{max} =$	11,176 psf	
$q_{ult} =$	25,000 psf	$q_{max} \leq q_{ult}$, OK

Per FHWA0-IF-03-017 Manual Section 5.4.4 - Bearing Capacity (Heave) Analysis per equation 5.14 is not required as soft soil is not present below the soil nail wall. Equivalent bearing capacity analyses has effectively been performed in the slope stability analysis that considers deep-seated failure surfaces below the toe of the wall.

Case: DRS4 BG1 bN ST - SEISMIC

Date: 7/16/2015

LADBS Check for soil nail wall to support EFP from Geotech

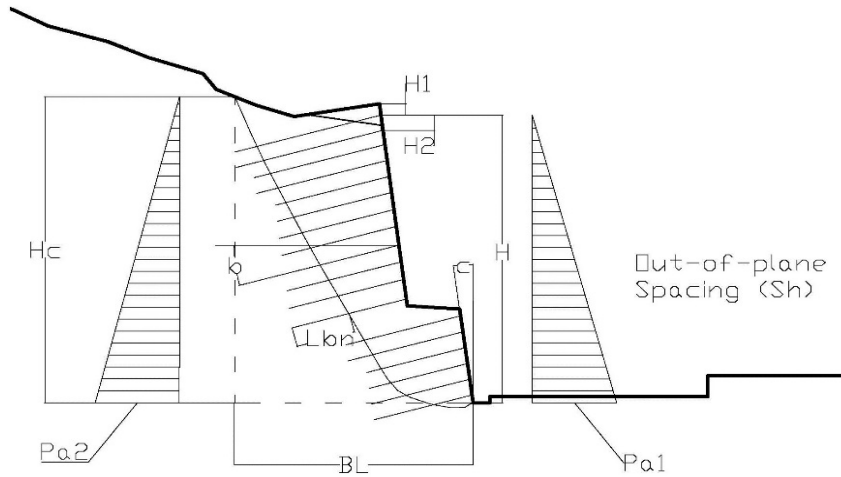

Soil Nail Wall Height	H =	90 ft	Nail Vert. Spacing	H2, H3...=	5 ft
No Rows Nails	n =	18	Nail Horz. Spacing	Sh =	5 ft
Depth to top nail	H1 =	2 ft	Wall face angle	c =	7 deg
Allowable bond stress (Bedrock)	BS1 =	10.7 psi	Soil Nail dia	d =	6 in
Effective EFP (from Geotech)	Pa =	10 pcf	=> Total EFP over Sh =	(Pa.H ²)/2 . Sh =	202.5 kip

Soil Nail Row	Hn	Nail Length ft	Soil Nail Incln. Angle (b) deg	Lbn ft	Lbn soil type	Static Capacity Lbns kip
1	2	45	15	6.8	Bedrock	15.9
2	7	45	15	8.4	Bedrock	19.6
3	12	40	15	4.9	Bedrock	11.5
4	17	40	15	6.6	Bedrock	15.4
5	22	35	15	3.3	Bedrock	7.7
6	27	35	15	5.0	Bedrock	11.7
7	32	35	15	6.9	Bedrock	16.1
8	37	35	15	8.7	Bedrock	20.3
9	42	35	15	10.9	Bedrock	25.5
10	47	35	15	12.9	Bedrock	30.2
11	52	35	15	15.0	Bedrock	35.1
12	57	35	15	17.3	Bedrock	40.4
13	62	35	15	5.6	Bedrock	13.1
14	67	35	15	7.5	Bedrock	17.5
15	72	30	15	4.4	Bedrock	10.3
16	77	30	15	6.6	Bedrock	15.4
17	82	30	15	10.6	Bedrock	24.8
18	87	30	15	18.3	Bedrock	42.8

Total Capacity = **373.3** kip

Total capacity / Total EFP: FS = $\sum Lbns / Psh$

Factor of Safety = 1.84 > 1.0 - OK

Case: DRS4 BG1 bN ST - SEISMIC

Date: 7/16/2015

Sliding Check:

Sliding failure may occur when additional lateral earth pressures, mobilized by the excavation, exceed the sliding resistance along the base. Soil nail wall system is modeled as a rigid block against which the lateral earth forces are applied behind the retained soil.

Height at the cut-section, $H_c =$	93.5 ft	<i>(height from top to bottom of wall at the failure surface)</i>
Dist. of failure surface from wall, $B_f =$	70.5 ft	<i>(horizontal distance to failure surface from bottom of wall)</i>
E.F.P for Sliding, $Pa_2 =$	30 pcf	<i>(from geotech)</i>
Unit weight of the soil behind wall, $Y =$	100 pcf	
Soil cohesion strength, $c_b =$	1044 psf	
Coefficient of friction, $\tan \Phi =$	0.5	
Weight of soil block, $W =$	647 kip/ft	<i>$(H+H_c)/2 \cdot BL \cdot Y$</i>
Driving Force, $P =$	131 kip/ft	<i>$(1/2 \cdot Pa_2 \cdot H_c^2)$</i>
Resisting Force =	397 kip/ft	<i>$(c_b \cdot BL + (W + Pa_2 \cdot \sin \beta) \cdot \tan \Phi)$; $\beta = 0$, conservatively)</i>
Factor of Safety =	3.03	

>1.0 - OK

Bearing Capacity (due to overturning) Check:

$y = H_c/3 =$	31.2 ft	
Overturning Moment, $M =$	4,083 ft-kip/ft	<i>$(P \cdot y)$</i>
$X_0 =$	28.9 ft	<i>$(W \cdot B/2 - M)/W$</i>
Check for eccentricity: $e = B_f/2 - X_0 =$	6.3 ft	$B_f/6 = 11.8$ ft $e < B/6$, OK
$B' =$	57.9 ft	
$q_{max} =$	11,176 psf	
$q_{ult} =$	25,000 psf	$q_{max} \leq q_{ult}$, OK

Per FHWA0-IF-03-017 Manual Section 5.4.4 - Bearing Capacity (Heave) Analysis per equation 5.14 is not required as soft soil is not present below the soil nail wall. Equivalent bearing capacity analyses has effectively been performed in the slope stability analysis that considers deep-seated failure surfaces below the toe of the wall.

Case: DRS5 BG6 bN ST - STATIC

Date: 7/16/2015

LADBS Check for soil nail wall to support EFP from Geotech

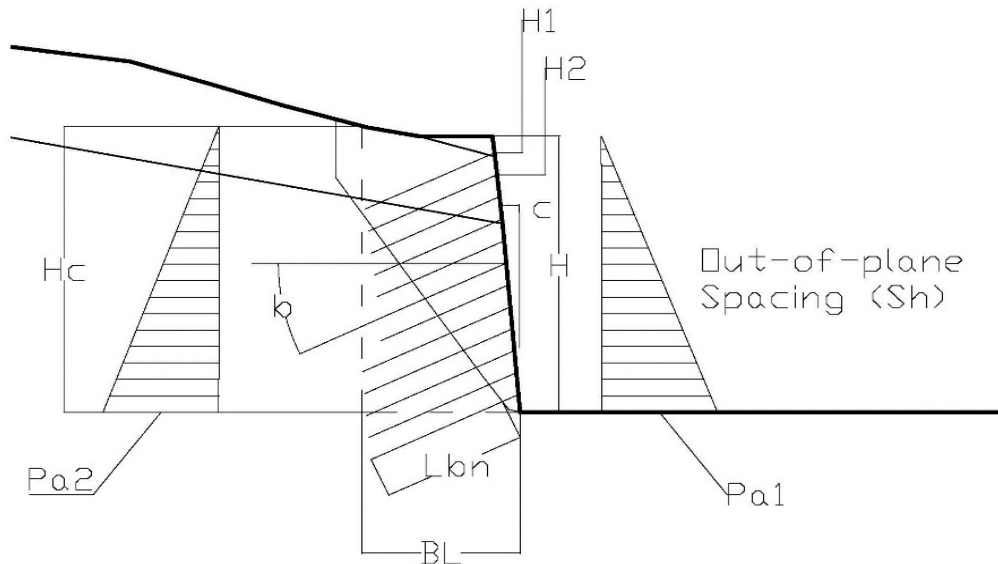

Soil Nail Wall Height	H =	63 ft	Nail Vert. Spacing	H2, H3...=	5 ft
No Rows Nails	n =	12	Nail Horz. Spacing	Sh =	5 ft
Depth to top nail	H1 =	2 ft	Wall face angle	c =	7 deg
Allowable bond stress (Bedrock)	BS1 =	8 psi	Soil Nail dia	d =	6 in

Effective EFP (from Geotech) Pa = 16 pcf => Total EFP over Sh= $(Pa \cdot H^2)/2 \cdot Sh =$ **158.8 kip**

Soil Nail Row	Hn	Nail Length ft	Soil Nail Incln. Angle (b) deg	Lbn ft	Lbn soil type	Static Capacity Lbns kip
1	2	30	25	0.0	Bedrock	0.0
2	7	30	25	1.2	Bedrock	2.0
3	12	30	25	3.6	Bedrock	5.9
4	17	30	25	5.9	Bedrock	9.7
5	22	30	25	8.4	Bedrock	13.8
6	27	30	25	10.9	Bedrock	17.9
7	32	30	25	13.4	Bedrock	22.0
8	37	35	25	20.9	Bedrock	34.3
9	42	35	25	23.5	Bedrock	38.5
10	47	35	25	26.0	Bedrock	42.6
11	52	35	25	28.5	Bedrock	46.7
12	57	35	25	31.2	Bedrock	51.2

Total Capacity = **284.5** kip

Total capacity / Total EFP: FS = $\sum Lbns / Psh$ Factor of Safety = 1.79 > 1.0 - OK

Case: DRS5 BG6 bN ST - STATIC

Date: 7/16/2015

Sliding Check:

Sliding failure may occur when additional lateral earth pressures, mobilized by the excavation, exceed the sliding resistance along the base. Soil nail wall system is modeled as a rigid block against which the lateral earth forces are applied behind the retained soil.

Height at the cut-section, $H_c =$	65.5 ft	<i>(height from top to bottom of wall at the failure surface)</i>
Dist. of failure surface from wall, $B_L =$	34 ft	<i>(horizontal distance to failure surface from bottom of wall)</i>
E.F.P for Sliding, $Pa_2 =$	25 pcf	<i>(from geotech)</i>
Unit weight of the soil behind wall, $Y =$	100 pcf	
Soil cohesion strength, $c_b =$	1044 psf	
Coefficient of friction, $\tan \Phi =$	0.5	
Weight of soil block, $W =$	218 kip/ft	<i>$(H+H_c)/2 \cdot BL \cdot Y$</i>
Driving Force, $P =$	54 kip/ft	<i>$(1/2 \cdot Pa_2 \cdot H_c^2)$</i>
Resisting Force =	145 kip/ft	<i>$(c_b \cdot BL + (W + Pa_2 \cdot \sin \beta) \cdot \tan \Phi)$; $\beta = 0$, conservatively)</i>
Factor of Safety =	2.69	

>1.0 - OK

Bearing Capacity (due to overturning) Check:

$y = H_c/3 =$	21.8 ft	
Overturning Moment, $M =$	1,179 ft-kip/ft	<i>$(P \cdot y)$</i>
$X_0 =$	11.6 ft	<i>$(W \cdot B/2 - M)/W$</i>
Check for eccentricity: $e = B_L/2 - X_0 =$	5.4 ft	$B_L/6 = 5.7 \text{ ft} \quad e < B/6, \text{ OK}$
$B' =$	23.2 ft	
$q_{\max} =$	9,414 psf	
$q_{\text{ult}} =$	25,000 psf	$q_{\max} \leq q_{\text{ult}}, \text{ OK}$

Per FHWA0-IF-03-017 Manual Section 5.4.4 - Bearing Capacity (Heave) Analysis per equation 5.14 is not required as soft soil is not present below the soil nail wall. Equivalent bearing capacity analyses has effectively been performed in the slope stability analysis that considers deep-seated failure surfaces below the toe of the wall.

Case: DRS5 BG6 bN ST - SEISMIC

Date: 7/16/2015

LADBS Check for soil nail wall to support EFP from Geotech

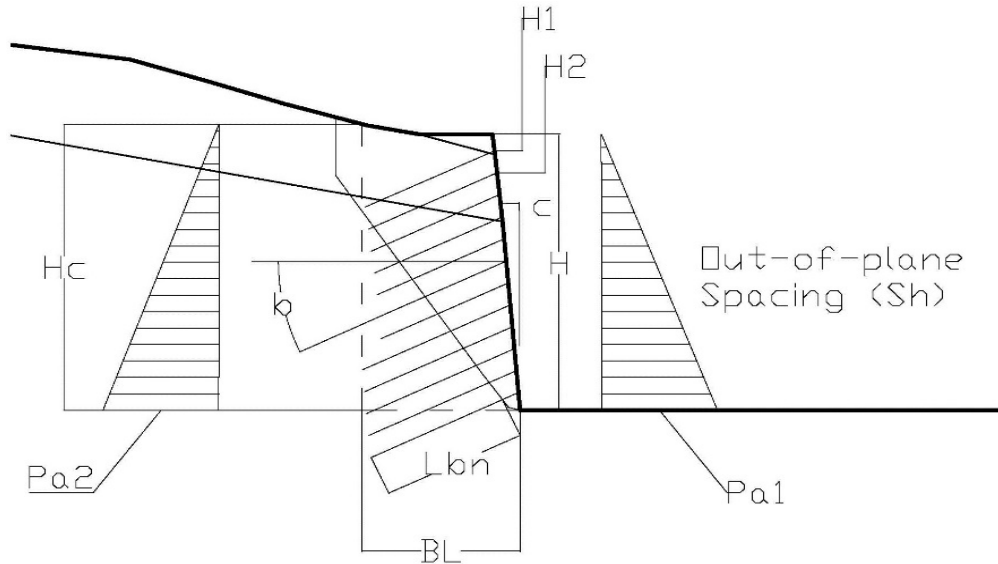

Soil Nail Wall Height	H =	63 ft	Nail Vert. Spacing	H2, H3...=	5 ft
No Rows Nails	n =	12	Nail Horz. Spacing	Sh =	5 ft
Depth to top nail	H1 =	2 ft	Wall face angle	c =	7 deg
Allowable bond stress (Bedrock)	BS1 =	10.7 psi	Soil Nail dia	d =	6 in

Effective EFP (from Geotech) Pa = 16 pcf => Total EFP over Sh= $(Pa \cdot H^2)/2 \cdot Sh =$ **158.8 kip**

Soil Nail Row	Hn	Nail Length ft	Soil Nail Incln. Angle (b) deg	Lbn ft	Lbn soil type	Static Capacity Lbns kip
1	2	30	25	0.0	Bedrock	0.0
2	7	30	25	1.2	Bedrock	2.6
3	12	30	25	3.6	Bedrock	7.9
4	17	30	25	5.9	Bedrock	12.9
5	22	30	25	8.4	Bedrock	18.4
6	27	30	25	10.9	Bedrock	23.9
7	32	30	25	13.4	Bedrock	29.4
8	37	35	25	20.9	Bedrock	45.8
9	42	35	25	23.5	Bedrock	51.5
10	47	35	25	26.0	Bedrock	57.0
11	52	35	25	28.5	Bedrock	62.5
12	57	35	25	31.2	Bedrock	68.4

Total Capacity = **380.6** kip

Total capacity / Total EFP: $FS = \sum Lbns / Psh$ Factor of Safety = 2.40 > 1.0 - OK

Case: DRS5 BG6 bN ST - SEISMIC

Date: 7/16/2015

Sliding Check:

Sliding failure may occur when additional lateral earth pressures, mobilized by the excavation, exceed the sliding resistance along the base. Soil nail wall system is modeled as a rigid block against which the lateral earth forces are applied behind the retained soil.

Height at the cut-section, $H_c =$	65.5 ft	<i>(height from top to bottom of wall at the failure surface)</i>
Dist. of failure surface from wall, $B_f =$	34 ft	<i>(horizontal distance to failure surface from bottom of wall)</i>
E.F.P for Sliding, $Pa_2 =$	25 pcf	<i>(from geotech)</i>
Unit weight of the soil behind wall, $Y =$	100 pcf	
Soil cohesion strength, $c_b =$	1044 psf	
Coefficient of friction, $\tan \Phi =$	0.5	
Weight of soil block, $W =$	218 kip/ft	<i>$(H+H_c)/2 \cdot BL \cdot Y$</i>
Driving Force, $P =$	54 kip/ft	<i>$(1/2 \cdot Pa_2 \cdot H_c^2)$</i>
Resisting Force =	145 kip/ft	<i>$(c_b \cdot BL + (W + Pa_2 \cdot \sin \beta) \cdot \tan \Phi)$; $\beta = 0$, conservatively)</i>
Factor of Safety =	2.69	

>1.0 - OK

Bearing Capacity (due to overturning) Check:

$y = H_c/3 =$	21.8 ft	
Overturning Moment, $M =$	1,179 ft-kip/ft	<i>$(P \cdot y)$</i>
$X_0 =$	11.6 ft	<i>$(W \cdot B/2 - M)/W$</i>
Check for eccentricity: $e = B_f/2 - X_0 =$	5.4 ft	$B_f/6 = 5.7 \text{ ft} \quad e < B/6, \text{ OK}$
$B' =$	23.2 ft	
$q_{\max} =$	9,414 psf	
$q_{\text{ult}} =$	25,000 psf	$q_{\max} \leq q_{\text{ult}}, \text{ OK}$

Per FHWA0-IF-03-017 Manual Ssection 5.4.4 - Bearing Capacity (Heave) Analysis per equation 5.14 is not required as soft soil is not present below the soil nail wall. Equivalent bearing capacity analyses has effectively been performed in the slope stability analysis that considers deep-seated failure surfaces below the toe of the wall.

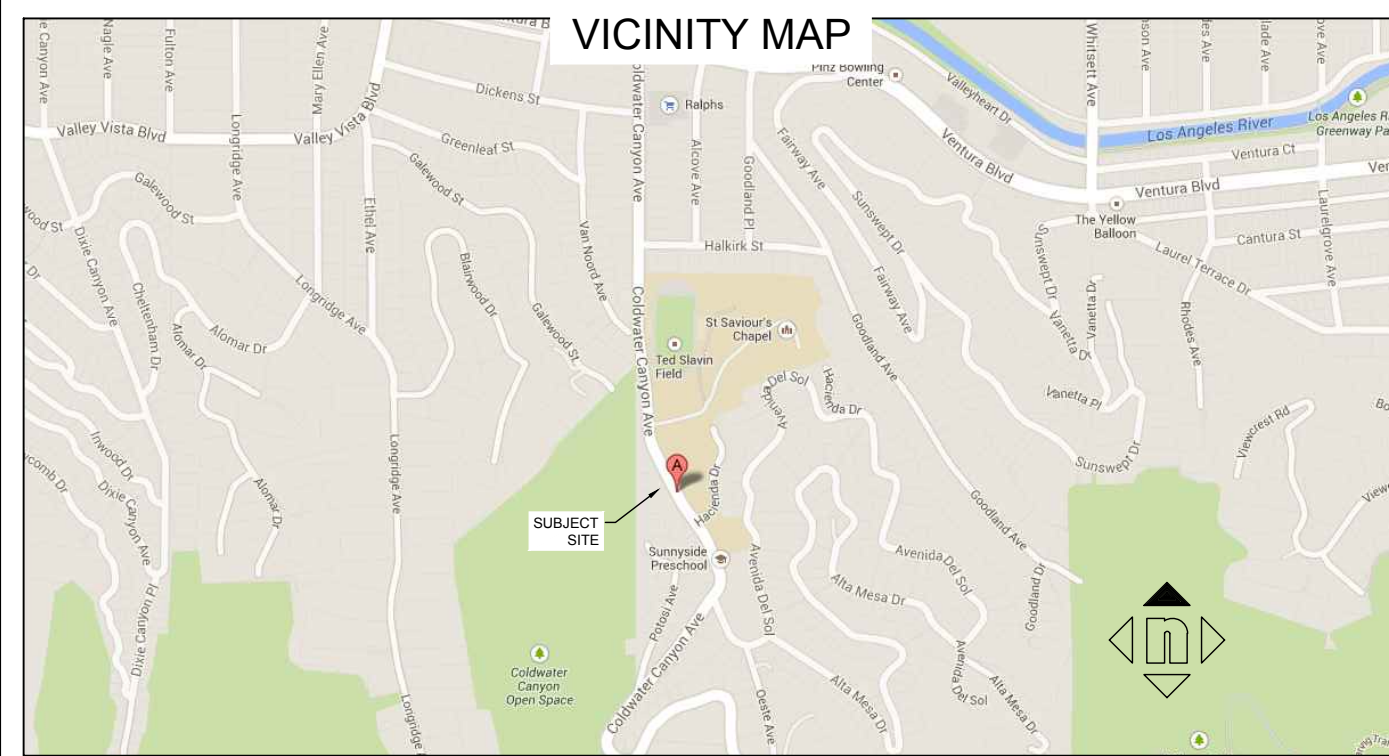

GENERAL NOTES

THE EARTH RETENTION DESIGNER IS DEFINED AS THE REGISTERED CIVIL ENGINEER WHOSE STAMP IS ON THESE PLANS. THE EARTH RETENTION CONTRACTOR IS DEFINED AS THE ORGANIZATION(S) OR PERSON(S) WHO INSTALL THE EARTH SUPPORT SYSTEMS INDICATED ON THESE PLANS.

THE GENERAL CONTRACTOR IS AS DEFINED AS THE ORGANIZATION(S) OR PERSON(S) WITH OVERALL CONTROL OF THE SITE CONSTRUCTION. THE PROJECT GEOTECHNICAL ENGINEER IS DEFINED AS THE ORGANIZATION OR PERSON WHO AUTHORED THE APPROVED SOILS/GEOTECHNOLOGY REPORT ASSOCIATED WITH THE PROJECT.

THESE EARTH RETENTION PLANS SHALL BE REVIEWED BY THE PROJECT GEOTECHNICAL ENGINEER PRIOR TO BEGINNING WORK.

LOCATION OF ALL EXISTING FACILITIES, ADJACENT STRUCTURES AND UNDERGROUND AND OVERHEAD UTILITIES SHOWN ARE AS INTERPRETED FROM INFORMATION PROVIDED TO DRS ENGINEERING DURING DESIGN. THE ACTUAL LOCATIONS OF ALL SUCH ITEMS SHALL BE FIELD VERIFIED PRIOR TO COMMENCING CONSTRUCTION OF THE EARTH RETENTION.

THE EARTH RETENTION CONTRACTOR SHALL BE RESPONSIBLE TO ENSURE THAT THE EARTH RETENTION IS BUILT IN ACCORDANCE WITH THESE PLANS. IF THERE IS ANY QUESTION REGARDING THESE PLANS, THE CONTRACTOR SHALL REQUEST AN INTERPRETATION BEFORE DOING ANY WORK BY CONTACTING THE EARTH RETENTION DESIGNER.

SITE DRAINAGE AND SITE DEDWATERING TO BE PROVIDED BY OTHERS. THE GENERAL CONTRACTOR SHALL ALSO TAKE THE NECESSARY STEPS TO PROTECT THE PROJECT AND ADJACENT PROPERTY FROM ANY EROSION AND SILTATION THAT RESULT FROM HIS OPERATIONS BY APPROPRIATE MEANS (SAND BAGS, HAY BALES, TEMPORARY DESILTING BASINS, DIKES, EARTH RETENTION, ETC.) UNTIL SUCH TIME THAT THE PROJECT IS COMPLETED AND ACCEPTED FOR MAINTENANCE BY THE OWNER. ALL CONSTRUCTION SHALL CONFORM TO ALL LOCAL CODES, ORDINANCES, RESTRICTIONS AND OSHA REQUIREMENTS.

NO EXCAVATION OR GRADING SHALL COMMENCE UNTIL 10 DAYS AFTER ADJOINING PROPERTY OWNERS HAVE BEEN NOTIFIED IN WRITING AS REQUIRED BY SECTION 3307.1 OF THE CALIFORNIA BUILDING CODE 2013.

EXCAVATION NOTIFICATION

CALL 1-800-422-4143 A MINIMUM OF TWO DAYS BEFORE COMMENCING EXCAVATION ENSURE ALL RELEVANT UTILITY COMPANIES HAVE CLEARED THE LOCATION. UPDATE ALL DIG ALERT NOTIFICATIONS EVERY TEN DAYS.

IF SOIL NAILS ARE TO BE INSTALLED WITHIN THREE FEET OF A UTILITY, THEN UTILITY MUST BE EXPOSED TO CONFIRM LOCATION AND CLEARANCE DURING DRILLING/DRIVING.

CODES AND SPECIFICATIONS

CALIFORNIA BUILDING CODE - 2013 EDITION SOIL NAIL WALL DESIGN - FHWA GEOTECHNICAL ENGINEERING CIRCULAR NO. 7 SOIL NAIL WALLS FHWA-ID-03-017 MARCH 2003 RECOMMENDED GUIDELINES FOR PERMANENT SOIL NAILS DATED 08-23-2000 - CALIFORNIA SOIL NAIL COMMITTEE

DESIGN CRITERIA

DESIGN IS IN ACCORDANCE WITH THE GEOTECHNICAL REPORT FOR THE PROJECT BY BYER GEOTECHNICAL PROJECT NO. 21086 DATED APRIL 2015.

GEOTECHNICAL DESIGN PARAMETERS ARE AS FOLLOWS:

SEISMIC COEFFICIENT Kh = 0.27g

Table with columns: SOIL TYPE, UNIT WEIGHT PCF, FRICTION ANGLE DEG., COHESION PSF, ULTIMATE BOND STRESS PSI, WORKING BOND STRESS PSI. Rows include BEDROCK (SECTIONS 3 TO 7), BEDROCK (SECTIONS 1, 2 - WEAK ZONE), BEDROCK (SECTIONS 1, 2 - OTHER AREAS), FILL, and ALLUVIUM.

MATERIALS

REINFORCING STEEL - ASTM A-615 - GRADE 60 WELDED WIRE FABRIC - PLAIN WIRE REINFORCEMENT ASTM A-185 Pw (min) = 56ksi HEADED STUDS - H4L MILD STEEL NELSON STUDS TO ASTM A-108 SOIL NAIL BAR - ASTM A-615 GRADE 75 SOLID BAR WELDING ELECTRODES - E-70 ksi CEMENT - ASTM C-150, TYPE II / V SHOTCRETE - fc (28) = 4000psi SOIL NAILS GROUT - NEAT WATER/CEMENT GROUT 0.45 W/C RATIO (fc 28 DAY) = 4000psi MIN. WALL DRAINAGE - MIRADRAIN 6200XL OR EQUIVALENT

MEMBERS OR DETAILS MAY BE SUBSTITUTED FOR EQUIVALENT OR BETTER, AS APPROVED BY ENGINEER.

SOILS ENGINEER AND GEOLOGIST

THIS PLAN HAS BEEN REVIEWED AND CONFORMS TO RECOMMENDATIONS OF SOILS ENGINEERING / GEOLOGIC REPORTS REFERENCED ABOVE.

SIGNATURE AND DATE

GENERAL PROCEDURES

ALL NECESSARY PERMITS SHALL BE OBTAINED (BY OTHERS) PRIOR TO GRADING AND CONSTRUCTION OF SOIL NAIL WALL.

GENERAL CONTRACTOR AND EARTH RETENTION CONTRACTOR WILL FOLLOW ALL APPLICABLE CAL-OSHA REQUIREMENTS IN THE EXECUTION OF THE WORK DESCRIBED HEREIN.

PRIOR TO THE START OF WORK THE EXISTING GRADE ELEVATIONS AND THE LOCATION AND DEPTH OF ALL EXISTING AND NEW UTILITIES, IF ANY, SHALL BE DETERMINED BY THE GENERAL CONTRACTOR AND PROVIDED IN WRITING TO THE EARTH RETENTION CONTRACTOR.

LAYOUT OF SOIL NAIL WALL LINE AND ELEVATIONS SHALL BE PROVIDED BY GENERAL CONTRACTOR.

SEQUENCE OF INSTALLATION

EXCAVATION FOR SOIL NAILS SHOULD BE MADE IN VERTICAL LIFTS TO ACCOMMODATE THE VERTICAL NAIL SPACING INDICATED ON THESE PLANS.

WHERE COLD JOINTS BETWEEN VERTICAL LIFTS OF STRUCTURAL SHOTCRETE ARE CREATED, THE PROCEDURE FOR FINISHING CURING, ROUGHENING AND RE-APPLYING SHOTCRETE AT THE COLD JOINT SHOULD BE IN ACCORDANCE WITH ACI-908R.

CONSTRUCTION SEQUENCE

- 1. EXCAVATE A VERTICAL CUT TO APPROX. 2FT BELOW THE UPPER ROW OF SOIL NAILS. 2. DRILL AND INSTALL UPPER ROW OF SOIL NAILS. 3. PLACE TEMPORARY FACING DRAINAGE CHIMNEYS AND REINFORCING AND SHOOT TEMPORARY SHOTCRETE FACING. 4. PROOF TEST SOIL NAILS AS REQUIRED FOR THIS NAIL ROW 5. REPEAT STEPS 1 TO 4 FOR SUBSEQUENT SOIL NAIL ROWS UNTIL SUBGRADE IS REACHED. 6. INSTALL PERMANENT FACING, DRAINAGE AND REINFORCING. 7. SHOTCRETE PERMANENT FACING.

SOIL NAIL INSTALLATION

HOLES SHALL BE DRILLED TO THE DIAMETER, DEPTH AND LINE AS INDICATED ON THE DRAWINGS. THE HOLE SHALL BE DRILLED SO THAT ITS DIAMETER IS NOT MORE THAN 1/4 INCH SMALLER THAN THE SPECIFIED DIAMETER. HOLES SHALL BE DRILLED AT AN INCLINATION AS SHOWN ON THESE DRAWING TOLERANCES FOR DRILL HOLE LOCATION SHALL BE +/- ONE FOOT FOR HORIZONTAL AND VERTICAL POSITION AT THE WALL FACE AND WITHIN 2.5 DEGREES OF THE SPECIFIED SOIL NAIL GRADIENT.

TO THE EXTENT PRACTICABLE, SOILS NAILS SHALL BE SHOP FABRICATED, SOIL NAILS SHALL BE HANDLED AND PROTECTED IN SUCH A MANNER AS TO AVOID CORROSION AND PHYSICAL DAMAGE THERETO.

PRIOR TO PLACEMENT, SOIL NAILS SHALL BE FREE OF DIRT, DETRIMENTAL RUST OR ANY OTHER DELETERIOUS SUBSTANCES. DRILLED HOLES SHALL BE CLEARED OF ANY LOOSE ROCK FRAGMENTS, SOIL OR OTHER SUBSTANCES WHICH MAY PREVENT THE PROPER PLACEMENT OF THE SOIL NAIL OR GROUT.

SOIL NAILS SHALL BE PLACED IN ACCORDANCE WITH RECOMMENDATIONS OF THE MANUFACTURER. SOIL NAILS SHALL BE SECURELY FASTENED IN PLACE TO PREVENT MOVEMENT DURING GROUTING AND TO ASSURE THAT THE BOND LENGTH OF THE SOIL NAIL IS CENTRALLY LOCATED IN THE DRILL HOLE.

WATER CEMENT SHALL HAVE A WATER CEMENT RATIO (w/c) OF 0.45

GROUT SHALL BE PUMPED INTO THE SOIL HOLE THROUGH A TREMIE GROUT TUBE PROVIDED BY THE CONTRACTOR FOR THAT PURPOSE UNTIL THE HOLE IS FILLED TO THE TOP OF THE SOIL NAIL ZONE. PROVISIONS SHALL BE MADE FOR DETERMINING THE TOP OF THE GROUT TO ASSURE ADEQUATE SOIL NAILAGE.

AFTER GROUTING, THE SOIL NAIL SHALL REMAIN UNDISTURBED UNTIL THE NECESSARY GROUT STRENGTH HAS BEEN ATTAINED.

SOIL NAIL TESTING EQUIPMENT

SOIL NAIL MOVEMENT SHALL BE MONITORED BY THE USE OF A DIAL GAUGES CAPABLE OF MEASURING TO 0.001 INCH. THE DIAL GAUGES SHALL HAVE A MINIMUM STROKE EQUAL TO THE THEORETICAL ELASTIC ELONGATION OF THE TOTAL NAIL LENGTH PLUS 1 INCH. THE DIAL GAUGES SHALL BE ALIGNED WITHIN 5 DEGREES FROM THE AXIS OF THE NAIL.

A HYDRAULIC JACK AND PUMP SHALL BE USED TO APPLY THE TEST LOAD. THE JACK AND PRESSURE GAUGE SHALL BE CALIBRATED BY AN INDEPENDENT TESTING LABORATORY AS A UNIT. THE PRESSURE GAUGE SHALL BE GRADUATED IN 100 PSI INCREMENTS OR LESS AND SHALL HAVE A RANGE NOT EXCEEDING TWICE THE ANTICIPATED MAXIMUM PRESSURE DURING TESTING. THE MINIMUM RAM TRAVEL OF THE JACK SHALL NOT BE LESS THAN THE THEORETICAL ELASTIC ELONGATION OF THE TOTAL NAIL LENGTH AT THE MAXIMUM TEST LOAD PLUS 1 INCH. THE JACK SHALL BE CAPABLE OF APPLYING EACH LOAD IN LESS THAN 1 MINUTE. THE CONTRACTOR SHALL PROVIDE A RECENT (WITHIN 60 DAYS) CALIBRATION CURVES FOR THE JACK AND PRESSURE GAUGE.

THE STRESSING EQUIPMENT SHALL BE PLACED OVER THE NAIL IN SUCH A MANNER THAT THE JACK, BEARING PLATES, LOAD CELL, AND STRESSING ANCHORAGE ARE IN ALIGNMENT. THE JACK SHALL BE POSITIONED AT THE BEGINNING OF THE TEST SUCH THAT UNLOADING AND REPOSITIONING OF THE JACK DURING THE TEST WILL NOT BE REQUIRED.

THE REACTION FRAME SHALL BE SUFFICIENTLY RIGID AND OF ADEQUATE DIMENSION SUCH THAT EXCESSIVE DEFORMATION OF THE TEST APPARATUS REQUIRING REPOSITIONING OF ANY COMPONENTS SHALL BE AVOIDED. WHERE THE REACTION FRAME BEARS DIRECTLY ON THE SHOTCRETE, THE REACTION FRAME SHALL BE DESIGNED TO PRECLUDE FRACTURE OF THE SHOTCRETE. NO PART OF THE REACTION FRAME SHALL BEAR WITHIN 6 INCHES OF THE EDGE OF THE TEST NAIL BLOCKOUT.

SOIL NAIL TESTING VERIFICATION TESTS

TWO (2) VERIFICATION TEST NAILS SHALL BE INSTALLED IN EACH SOIL STRATA. COMPLETION OF SUCCESSFUL VERIFICATION TESTS IS REQUIRED PRIOR TO INSTALLATION OF PRODUCTION NAILS IN THAT STRATA. THE NAILS USED FOR THE VERIFICATION TESTS SHALL BE SACRIFICIAL AND SHALL NOT BE INCORPORATED INTO THE PRODUCTION NAIL SCHEDULE. THE LOCATION OF THE VERIFICATION NAILS WILL BE DECIDED AND AGREED WITH THE GEOTECHNICAL ENGINEER OF RECORD PRIOR TO INSTALLATION AND TESTING.

VERIFICATION TESTS SHALL BE PERFORMED ON SACRIFICIAL NAILS TO THE ULTIMATE BOND STRESS VALUE. INSTALL THE TEST NAILS BY THE SAME METHOD THAT IS USED FOR PRODUCTION NAILS, EXCEPT GROUT. ONLY THE BOND LENGTH SPECIFIED ON THESE PLANS. VERIFICATION TEST NAILS MAY BE PLAIN BAR AND NEED NOT BE ENCAPSULATED IN HOPE SHEATHING.

Table with columns: VERIFICATION TEST NAILS DIMENSIONS AND TEST LOADS, ULTIMATE GROUT/GROUND BOND STRESS, ALLOWABLE GROUT/GROUND BOND STRESS, HOLE DIAMETER, VERIFICATION TEST NAIL UN-BONDED LENGTH, VERIFICATION TEST NAIL BONDED LENGTH, DESIGN LOAD (DL), MAXIMUM TEST LOAD (2.00 DL).

SELECT THE VERIFICATION TEST NAIL BAR SIZE SUCH THAT THE MAXIMUM STRESS IN THE BAR AT THE MAXIMUM TEST LOAD DOES NOT EXCEED 0.9f.

VERIFICATION TEST NAILS SHALL BE INCREMENTALLY LOADED TO TWICE THE DESIGN LOAD AND MOVEMENTS RECORDED IN ACCORDANCE WITH THE FOLLOWING SCHEDULE.

Table with columns: AL, DL, AL - ALIGNMENT LOAD, DL - NAIL DESIGN LOAD. Rows include 0.25 DL, 0.50 DL, 0.75 DL, 1.00 DL, 1.25 DL, 1.50 DL, 1.75 DL, 2.00 DL.

ALL LOAD INCREMENTS SHALL BE MAINTAINED WITHIN 5 PERCENT OF THE INTENDED LOAD. THE VERIFICATION TEST NAIL SHALL BE MONITORED FOR CREEP AT 1.50 DL LOAD INCREMENTS. CREEP PERIOD SHALL START AS SOON AS THE MAXIMUM TEST LOAD IS APPLIED AND THE NAIL MOVEMENT WITH RESPECT TO A FIXED REFERENCE SHALL BE MEASURED AND RECORDED AT 1 MINUTE, 2, 3, 5, 6, 10, 20, 30, 50 AND 60 MINUTES. THE VERIFICATION TEST NAIL SHALL BE UNLOADED IN INCREMENTS OF 25 PERCENT WITH MEASUREMENTS OF DEFLECTION AT EACH INCREMENT.

UPON SUCCESSFUL COMPLETION OF THE VERIFICATION TEST, THE NAIL SHALL BE LOADED IN 25 PERCENT INCREMENTS. EACH LOAD INCREMENT SHALL BE HELD UNTIL A STABLE READING IS OBTAINED AND THE NAIL EXTENSION AT THAT INCREMENT RECORDED. LOAD SHALL BE INCREASED IN 25% INCREMENTS UNTIL EITHER CONSTANT LOAD RESULTS IN CONTINUOUS EXTENSION OR THE MAXIMUM TEST LOAD IS REACHED. THE MAXIMUM TEST LOAD ACHIEVED AND THE CORRESPONDING BAR EXTENSION SHALL BE RECORDED.

VERIFICATION TEST ACCEPTANCE CRITERIA:

FOR VERIFICATION TESTS, IF THE CREEP CURVE INDICATES A CREEP RATE OF LESS THAN 0.08 INCHES PER LOG CYCLE TIME, AND THE RATE IS LINEAR OR DECREASING THROUGHOUT THE HOLD LOAD, THE TEST IS SUCCESSFUL.

SOIL NAIL TESTING cont..... PROOF TESTS

PROOF TESTS SHALL BE PERFORMED ON FIVE PERCENT (5%) OF THE SOIL NAILS TO VERIFY THE BOND STRESS VALUE ASSUMED IN THE DESIGN. NAILS SHOULD BE TESTED ON EVERY LIFT AND ON DIFFERENT LOCATIONS ALONG THE WALL. PROOF TESTS SHALL BE PERFORMED USING TESTING EQUIPMENT CALIBRATED WITHIN 60 DAYS OF START OF TESTING.

Table with columns: PROOF TEST NAILS DIMENSIONS AND TEST LOADS, ULTIMATE GROUT/GROUND BOND STRESS, ALLOWABLE GROUT/GROUND BOND STRESS, HOLE DIAMETER, VERIFICATION TEST NAIL UN-BONDED LENGTH, VERIFICATION TEST NAIL BONDED LENGTH, DESIGN LOAD (DL), MAXIMUM TEST LOAD (1.50 DL).

PROOF TESTS SHALL BE PERFORMED ON PRODUCTION NAILS TO 150% OF THE ALLOWABLE BOND STRESS VALUE USED IN DESIGN. INSTALL THE PROOF TEST NAILS BY THE SAME METHOD THAT IS USED FOR ALL PRODUCTION NAILS, EXCEPT GROUT ONLY THE BOND LENGTH SPECIFIED ON THESE PLANS.

SECURELY BLOCK OUT THE FRONT ONE FOOT OF THE SOIL NAIL HOLE WITH LOOSE SOIL OR OTHER FLEXIBLE MATERIAL TO AVOID PENETRATION OF SHOTCRETE IN THE OPEN HOLE. PERFORM THE PROOF TEST BY LOADING THE SOIL NAIL IN FOLLOWING INCREMENTS:

Table with columns: AL, DL, AL - ALIGNMENT LOAD, DL = NAIL DESIGN LOAD. Rows include 0.25 DL, 0.50 DL, 0.75 DL, 1.00 DL, 1.50 DL.

ALL LOAD INCREMENTS SHALL BE MAINTAINED WITHIN 5 PERCENT OF THE INTENDED LOAD, DEPENDING ON THE PERFORMANCE WITHIN 10 MINUTE OR 60 MINUTE CREEP TESTS SHALL BE PERFORMED AT THE MAXIMUM TEST LOAD. THE CREEP PERIOD SHALL START AS SOON AS THE MAXIMUM TEST LOAD IS APPLIED AND THE NAIL MOVEMENT WITH RESPECT TO A FIXED REFERENCE SHALL BE MEASURED AND RECORDED AT 1 MINUTE, 2, 3, 5, 6, 10 MINUTES. WHERE NAIL MOVEMENT BETWEEN 1 MINUTE AND 10 MINUTES EXCEEDS 0.4 INCHES, THE MAXIMUM TEST LOAD SHALL BE MAINTAINED AN ADDITIONAL 50 MINUTES AND MOVEMENTS SHALL BE RECORDED AT 20 MINUTE, 30, 50, AND 60 MINUTES.

PROOF TEST ACCEPTANCE CRITERIA:

IF AT THE PROOF TEST LOAD THE MOVEMENT BETWEEN 1 AND 10 MINUTES IS LESS THAN 0.04 INCH, THE TEST IS SUCCESSFUL. IF THE MOVEMENT BETWEEN 1 AND 10 MINUTES IS GREATER THAN 0.04 INCH, THE TEST SHALL BE HELD FOR AN ADDITIONAL 50 MINUTES AND A CREEP CURVE SHALL BE PLOTTED FOR MOVEMENT BETWEEN 6 AND 60 MINUTES. IF THE CREEP CURVE INDICATES A CREEP RATE OF LESS THAN 0.08 INCHES PER LOG CYCLE TIME, THE TEST IS SUCCESSFUL.

ALL TEST RESULTS SHOULD BE PROVIDED TO THE DESIGNER WITHIN 5 DAYS OF TESTING AND IMMEDIATELY FOR ANY TESTS THAT FAIL TO MEET THE ACCEPTANCE CRITERIA.

TEMPORARY SHOTCRETE

SUBMIT MIX DESIGN TO ENGINEER FOR APPROVAL MAXIMUM SLUMP: 2 1/2"

NO ADMIXTURES SHALL BE USED WITHOUT THE APPROVAL OF THE ENGINEER.

THE MIXING TIME FOR MATERIALS DELIVERED BY READY-MIX TRUCKS TO THE JOB SITE SHALL NOT EXCEED TWO HOURS OR 250 REVOLUTIONS OF THE DRUM, WHICHEVER COMES FIRST.

ALL REINFORCEMENT SHALL BE CLEAN AND FREE FROM LOOSE MILL SCALE, LOOSE RUST, OIL OR OTHER COATING INTERFERING WITH BOND.

ALL VERTICAL EXCAVATIONS SHALL BE COVERED WITH SHOTCRETE THE SAME DAY AS EXCAVATION OCCURS.

VERTICAL FACES THAT CANNOT BE COVERED WITH SHOTCRETE FACING THE SAME DAY SHALL BE PROTECTED WITH A SOIL BERM. THE TEMPORARY BERM SHALL BE A MINIMUM OF 3FT WIDE WITH SIDE SLOPES LESS THAN OR EQUAL TO FIVE DEGREES.

WHERE VERTICAL CUTS DO NOT STAND WHILE DRILLING OR STAND LONG ENOUGH TO REFLECT SHOTCRETE THEN A SLOT CUTTING PROCEDURE SHALL BE EMPLOYED. SLOT CUT WIDTHS TO BE AGREED ON SITE BETWEEN THE EARTH RETENTION CONTRACTOR AND THE GEOTECHNICAL ENGINEER.

THICKNESS AND REINFORCEMENT COVER TOLERANCES: DESIGN CONCRETE THICKNESS AND CONCRETE COVER OVER REINFORCEMENT ARE SHOWN ON THE DRAWINGS. MINIMUM TOLERANCES FOR ON-PLACE THICKNESS SHALL BE 0.5 INCH.

SHOTCRETE SHALL BE APPLIED BY AN EXPERIENCED NOZZLEMAN WHOSE QUALIFICATIONS MEET THE MINIMUM REQUIREMENTS AS SET FORTH IN ACI 506R-90.

REBOUND: REBOUND MATERIAL CANNOT BE RE-USED AND MUST BE KEPT OUT OF THE WALL BY USE OF AIR HOSE.

SHOTCRETE SHALL BE PLACED IN CONTINUOUS HORIZONTAL LIFTS. SUBSEQUENT EXCAVATION BELOW A LIFT SHOULD NOT PROCEED UNTIL THE SHOTCRETE HAS CURED FOR A MINIMUM OF 36HRS OR IT CAN BE DEMONSTRATED THAT A COMPRESSIVE STRENGTH OF 2,000 PSI HAS BEEN ACHIEVED.

TEMPORARY SHOTCRETE MAY BE AIR CURED WITHOUT THE NEED FOR CURING COMPOUNDS OR APPLICATION OF WATER.

STRENGTH TEST FOR SHOTCRETE SHALL BE MADE BY AN APPROVED AGENCY ON SPECIMENS WHICH ARE REPRESENTATIVE OF WORK AND WHICH HAVE BEEN WATER SOAKED FOR AT LEAST 24 HOURS PRIOR TO TESTING. WHEN THE MAXIMUM SIZE AGGREGATE IS LARGER THAN 3/8", SPECIMENS SHALL CONSIST OF NOT LESS THAN THREE 3-INCH DIAMETER CORES OR 2" CUBES. WHEN THE MAXIMUM SIZE AGGREGATE IS SMALLER THAN 3/8", SPECIMENS SHALL CONSIST OF NOT LESS THAN THREE 2" DIAMETER CORES OR 2" CUBES.

TAKING AND TESTING OF SPECIMENS SHALL BE IN ACCORDANCE WITH ONE OF THE FOLLOWING

FROM THE IN-PLACE WORK: ONE SPECIMEN DURING EACH SHIFT WHEN SHOTCRETE WORK IS PERFORMED OR 1 SPECIMEN FOR EACH 50 CUBIC YARDS OR SHOTCRETE.

FROM TEST PANELS: MADE NOT LESS THAN ONCE EACH SHIFT OR NOT LESS THAN ONE FOR EACH 50 CUBIC YARDS OF SHOTCRETE PLACED. WHEN THE MAXIMUM SIZE AGGREGATE IS LARGER THAN 3/8 INCH, THE TEST PANEL SHALL HAVE A MINIMUM DIMENSION OF 18 INCHES BY 18 INCHES. WHEN THE MAXIMUM SIZE AGGREGATE IS 3/8 INCH OR SMALLER, THE TEST PANEL SHALL HAVE A MINIMUM DIMENSION OF 12 INCHES BY 12 INCHES. PANELS SHALL BE CURED IN THE SAME POSITION AS THE WORK, DURING THE COURSE OF THE WORK, AND BY THE NOZZLEMAN DOING THE WORK. THE POSITION UNDER WHICH THE PANELS ARE CURED SHALL BE THE SAME AS THE WORK. THE AVERAGE OF THREE CORES FROM A SINGLE PANEL SHALL BE EQUAL TO OR EXCEED 0.85 FC WITH NO SINGLE CORE LESS THAN 0.75 FC. THE AVERAGE OF THREE CUBES TAKEN FROM A SINGLE PANEL MUST EQUAL TO OR EXCEED FC WITH NO INDIVIDUAL CUBE LESS THAN 0.85 FC. TO CHECK TESTING ACCURACY, LOCATIONS REPRESENTED BY ERRATIC CORE STRENGTHS MAY BE RETESTED.

PERMANENT SHOTCRETE

REQUIREMENTS OF 2013 CALIFORNIA BUILDING CODE SECTION 1910.

1910.1 GENERAL. SHOTCRETE IS MORTAR OR CONCRETE THAT IS PNEUMATICALLY PROJECTED AT HIGH VELOCITY ONTO A SURFACE. EXCEPT AS SPECIFIED IN THIS SECTION, SHOTCRETE SHALL CONFORM TO THE REQUIREMENTS OF THIS CHAPTER FOR PLAIN OR REINFORCED CONCRETE.

1910.2 PROPORTIONS AND MATERIALS. SHOTCRETE PROPORTIONS SHALL BE SELECTED THAT ALLOW SUITABLE PLACEMENT PROCEDURES USING THE DELIVERY EQUIPMENT SELECTED AND SHALL RESULT IN FINISHED IN-PLACE HARDENED SHOTCRETE MEETING THE STRENGTH REQUIREMENTS OF THIS CODE.

1910.3 AGGREGATE. COARSE AGGREGATE, IF USED, SHALL NOT EXCEED 3/4 INCH (19.1 MM).

1910.4 REINFORCEMENT. REINFORCEMENT USED IN SHOTCRETE CONSTRUCTION SHALL COMPLY WITH THE PROVISIONS OF SECTIONS 1910.4.1 THROUGH 1910.4.4.

1910.4.1 SIZE. THE MAXIMUM SIZE OF REINFORCEMENT SHA11 BE NO.5 BARS UNLESS IT IS DEMONSTRATED BY PRECONSTRUCTION TESTS THAT ADEQUATE ENCASEMENT OF LARGER BARS WILL BE ACHIEVED.

1910.4.2 CLEARANCE. WHEN NO.5 OR SMALLER BARS ARE USED, THERE SHALL BE A MINIMUM CLEARANCE BETWEEN PARALLEL REINFORCEMENT BARS OF 2 1/2 INCHES (64 MM). WHEN BARS LARGER THAN NO.5 ARE PERMITTED, THERE SHALL BE A MINIMUM CLEARANCE BETWEEN PARALLEL BARS EQUAL TO SIX DIAMETERS OF THE BARS USED. WHEN TWO CURTAINS OF STEEL ARE PROVIDED, THE CURTAIN NEAR THE NOZZLE SHALL HAVE A MINIMUM SPACING EQUAL TO 12 BAR DIAMETERS AND THE REMAINING CURTAIN SHALL HAVE A MINIMUM SPACING OF SIX BAR DIAMETERS. EXCEPTION: SUBJECT TO THE APPROVAL OF THE BUILDING OFFICIAL, REQUIRED CLEARANCES SHALL BE REDUCED WHERE IT IS DEMONSTRATED BY PRECONSTRUCTION TESTS THAT ADEQUATE ENCASEMENT OF THE BARS USED IN THE DESIGN WILL BE ACHIEVED.

1910.4.3 SPLICES. LAP SPLICES OF REINFORCING BARS SHALL UTILIZE THE NONCONTACT LAP SPLICE METHOD WITH A MINIMUM CLEARANCE OF 2 INCHES (51 MM) BETWEEN BARS. THE USE OF CONTACT LAP SPLICES NECESSARY FOR SUPPORT OF THE REINFORCING IS PERMITTED WHEN APPROVED BY THE BUILDING OFFICIAL. BASED ON SATISFACTORY PRECONSTRUCTION TESTS THAT SHOW THAT ADEQUATE ENCASEMENT OF THE BARS WILL BE ACHIEVED, AND PROVIDED THAT THE SPLICE IS ORIENTED SO THAT A PLANE THROUGH THE CENTER OF THE SPLICED BARS IS PERPENDICULAR TO THE SURFACE OF THE SHOTCRETE.

1910.4.4 SPIRALLY TIED COLUMNS. SHOTCRETE SHALL NOT BE APPLIED TO SPIRALLY TIED COLUMNS.

1910.5 PRECONSTRUCTION TESTS. WHEN REQUIRED BY THE BUILDING OFFICIAL, A TEST PANEL SHALL BE SHOT, CURED, CORED OR SAWN, EXAMINED AND TESTED PRIOR TO COMMENCEMENT OF THE PROJECT. THE SAMPLE PANEL SHALL BE REPRESENTATIVE OF THE PROJECT AND SIMULATE JOB CONDITIONS AS CLOSELY AS POSSIBLE. THE PANEL THICKNESS AND REINFORCING SHALL REPRESENT THE THICKEST AND MOST CONCENTRATED AREA OF REINFORCING IN THE STRUCTURAL DESIGN. IT SHALL BE SHOT AT THE SAME ANGLE, USING THE SAME NOZZLEMAN AND WITH THE SAME CONCRETE MIX DESIGN THAT WILL BE USED ON THE PROJECT. THE EQUIPMENT USED IN PRECONSTRUCTION TESTING SHALL BE THE SAME EQUIPMENT USED IN THE WORK REQUIRING SUCH TESTING, UNLESS SUBSTITUTE EQUIPMENT IS APPROVED BY THE BUILDING OFFICIAL.

1910.6 REBOUND. ANY REBOUND OR ACCUMULATED LOOSE AGGREGATE SHALL BE REMOVED FROM THE SURFACES TO BE COVERED PRIOR TO PLACING THE INITIAL OR ANY SUCCEEDING LAYERS OF SHOTCRETE. REBOUND SHALL NOT BE USED AS AGGREGATE.

PERMANENT SHOTCRETE cont.....

1910.7 JOINTS. EXCEPT WHERE PERMITTED HEREIN, UNFINISHED WORK SHALL NOT BE ALLOWED TO STAND FOR MORE THAN 30 MINUTES UNLESS EDGES ARE SLOPED TO A THIN EDGE. FOR STRUCTURAL ELEMENTS THAT WILL BE UNDER COMPRESSION AND FOR CONSTRUCTION JOINTS SHOWN ON THE APPROVED CONSTRUCTION DOCUMENTS, SQUARE JOINTS ARE PERMITTED. BEFORE PLACING ADDITIONAL MATERIAL ADJACENT TO PREVIOUSLY APPLIED WORK, SLOPING AND SQUARE EDGES SHALL BE CLEANED AND WETTED.

1910.8 DAMAGE. IN-PLACE SHOTCRETE THAT EXHIBITS SAGS, SLOUGHS, SEGREGATION, HONEYCOMBING, SAND POCKETS OR OTHER OBVIOUS DEFECTS SHALL BE REMOVED AND REPLACED. SHOTCRETE ABOVE SAGS AND SLOUGHS SHALL BE REMOVED AND REPLACED WHILE STILL PLASTIC.

1910.9 CURING. DURING THE CURING PERIODS SPECIFIED HEREIN, SHOTCRETE SHALL BE MAINTAINED ABOVE 40°F AND IN MOIST CONDITION.

1910.9.1 INITIAL CURING. SHOTCRETE SHALL BE KEPT CONTINUOUSLY MOIST FOR 24 HOURS AFTER SHOTCRETING IS COMPLETE OR SHALL BE SEALED WITH AN APPROVED CURING COMPOUND.

1910.9.2 FINAL CURING. FINAL CURING SHALL CONTINUE FOR SEVEN DAYS AFTER SHOTCRETING, OR FOR THREE DAYS IF HIGH EARLY STRENGTH CEMENT IS USED, OR UNTIL THE SPECIFIED STRENGTH IS OBTAINED. FINAL CURING SHALL CONSIST OF THE INITIAL CURING PROCESS OR THE SHOTCRETE SHALL BE COVERED WITH AN APPROVED MOISTURE-RETAINING COVER.

1910.9.3 NATURAL CURING. NATURAL CURING SHALL NOT BE USED IN LIEU OF THAT SPECIFIED IN THIS SECTION UNLESS THE RELATIVE HUMIDITY REMAINS AT OR ABOVE 85 PERCENT, AND IS AUTHORIZED BY THE REGISTERED DESIGN PROFESSIONAL AND APPROVED BY THE BUILDING OFFICIAL.

1910.10 STRENGTH TESTS. STRENGTH TESTS FOR SHOTCRETE SHALL BE MADE BY AN APPROVED AGENCY ON SPECIMENS THAT ARE REPRESENTATIVE OF THE WORK AND WHICH HAVE BEEN WATER SOAKED FOR AT LEAST 24 HOURS PRIOR TO TESTING. WHEN THE MAXIMUM SIZE AGGREGATE IS LARGER THAN INCH (9.5 MM), SPECIMENS SHALL CONSIST OF NOT LESS THAN THREE 3-INCH-DIAMETER (76 MM) CORES OR 3-INCH (76 MM) CUBES. WHEN THE MAXIMUM SIZE AGGREGATE IS 3/8 INCH (9.5 MM) OR SMALLER, SPECIMENS SHALL CONSIST OF NOT LESS THAN 2-INCH-DIAMETER (51 MM) CORES OR 2-INCH (51 MM) CUBES.

1910.10.1 SAMPLING. SPECIMENS SHALL BE TAKEN FROM THE IN-PLACE WORK OR FROM TEST PANELS, AND SHALL BE TAKEN AT LEAST ONCE EACH SHIFT BUT NOT LESS THAN ONE FOR EACH 50 CUBIC YARDS (38.2 M3) OF SHOTCRETE. 2013 CALIFORNIA BUILDING CODE AGGREGATE

1910.10.2 PANEL CRITERIA. WHEN THE MAXIMUM-SIZE AGGREGATE IS LARGER THAN INCH (9.5 MM), THE TEST PANELS SHALL HAVE MINIMUM DIMENSIONS OF 18 INCHES BY 18 INCHES (457 MM BY 457 MM), WHEN THE MAXIMUM SIZE AGGREGATE IS 3/8 INCH (9.5 MM) OR SMALLER, THE TEST PANELS SHALL HAVE MINIMUM DIMENSIONS OF 12 INCHES BY 12 INCHES (305 MM BY 305 MM). PANELS SHALL BE SHOT IN THE SAME POSITION AS THE WORK, DURING THE COURSE OF THE WORK AND BY THE NOZZLEMAN DOING THE WORK. THE CONDITIONS UNDER WHICH THE PANELS ARE CURED SHALL BE THE SAME AS THE WORK.

1910.10.3 ACCEPTANCE CRITERIA. THE AVERAGE COMPRESSIVE STRENGTH OF THREE CORES FROM THE IN-PLACE WORK OR A SINGLE TEST PANEL SHALL EQUAL OR EXCEED 0.85 F' WITH NO SINGLE CORE LESS THAN 0.75 F'. THE AVERAGE COMPRESSIVE STRENGTH OF THREE CUBES TAKEN FROM THE IN-PLACE WORK OR A SINGLE TEST PANEL SHALL EQUAL OR EXCEED FC WITH NO INDIVIDUAL CUBE LESS THAN 0.85 FC. TO CHECK ACCURACY, LOCATIONS REPRESENTED BY ERRATIC CORE OR CUBE STRENGTHS SHALL BE RETESTED.

ADDITIONAL PERMANENT SHOTCRETE REQUIREMENTS

EXCEPT AS OTHERWISE INDICATED HEREIN, SHOTCRETE SHALL CONFORM TO THE REQUIREMENTS OF ACI 506R-90.

SUBMIT MIX DESIGN TO ENGINEER FOR APPROVAL MAXIMUM SLUMP: 2 1/2" NO ADMIXTURES SHALL BE USED WITHOUT THE APPROVAL OF THE ENGINEER.

THE MIXING TIME FOR MATERIALS DELIVERED BY READY-MIX TRUCKS TO THE JOB SITE SHALL NOT EXCEED TWO HOURS OR 250 REVOLUTIONS OF THE DRUM, WHICHEVER COMES FIRST.

ALL REINFORCEMENT SHALL BE CLEAN AND FREE FROM LOOSE MILL SCALE, LOOSE RUST, OIL OR OTHER COATING INTERFERING WITH BOND.

THICKNESS AND REINFORCEMENT COVER TOLERANCES: DESIGN CONCRETE THICKNESS AND CONCRETE COVER OVER REINFORCEMENT IS SHOWN ON THE DRAWINGS. MINIMUM TOLERANCES FOR IN-PLACE THICKNESS SHALL BE MINUS 0.5 INCH. MINUS TOLERANCE ON COVER SHALL BE 0.5 INCH.

SOIL NAIL WALL MONITORING

THE SOIL NAIL WALL SHOULD BE MONITORED FOR MOVEMENT BOTH DURING CONSTRUCTION AND AFTER COMPLETION OF THE WALL.

SLOPE INCLINOMETERS SHOULD BE INSTALLED UPSLOPE AND WITHIN 10FT OF THE SOIL NAIL WALL. THE SLOPE INCLINOMETERS SHOULD CONSIST OF A 2 3/4" DIAMETER PVC SLOPE INDICATOR CASING INSTALLED WITHIN AN 8" DIAMETER DRILLED SHAFT. INCLINOMETER SHAFTS SHALL BE DRILLED USING A HOLLOW STEM AUGER DRILL AND BACK FILLED WITH A 5' BENTONITE TO CEMENT SLURRY AFTER CASING INSTALLATION. THE SLOPE INCLINOMETERS SHOULD EXTEND A MINIMUM OF 10FT BELOW THE BASE OF THE WALL. THE RECOMMENDED LOCATION OF THE SLOPE INCLINOMETERS ARE INDICATED ON THE GEOLOGIC MAP.

OPTICAL SURVEY POINTS AT A MINIMUM OR 40FT C/O ALONG THE TOP OF THE WALL SHOULD BE INSTALLED ALONG THE TOP OF THE SOIL NAIL WALL PRIOR TO EXCAVATION SUCH THAT THE LATERAL AND VERTICAL DEFORMATION OF THE TOP OF THE SOIL NAIL WALL CAN BE MONITORED DURING EXCAVATION.

IN ADDITION IT IS RECOMMENDED THAT TWENTY SOIL NAILS BE EQUIPPED WITH STRAIN GAUGES (OR OTHER APPROVED LOAD MONITORING SYSTEM) THAT WILL ENABLE REGULAR LONG-TERM MONITORING OF THE LOAD WITHIN THE SOIL NAILS AFTER COMPLETION OF THE WALL CONSTRUCTION. THESE MONITOR NAILS SHOULD BE DISTRIBUTED THROUGH THE SOIL NAIL WALL. THE STRAIN GAUGES SHOULD BE LOCATED ALONG THE NAIL LENGTH SUCH THAT THE LOAD DISTRIBUTION ALONG THE NAIL LENGTH CAN BE DETERMINED.

PRIOR TO ANY CONSTRUCTION ACTIVITIES THAT MAY AFFECT ADJACENT PROPERTIES, A COMPLETE EXISTING CONDITION SURVEY SHOULD BE UNDERTAKEN TO OBSERVE AND DOCUMENT THE PRE-CONSTRUCTION CONDITION OF ALL STRUCTURES, INFRASTRUCTURE, SIDEWALKS, ROADWAYS, AND ALL OTHER FACILITIES ADJACENT TO THE SITE. DOCUMENTATION SHALL BE CIRCULATED TO CONTRACTOR, ENGINEER AND OWNER PRIOR TO START OF EXCAVATION.

DURING THE EXCAVATION PHASE THE SOIL NAIL WALL SHALL BE INSPECTED DAILY BY VISUAL OBSERVATION FOR SIGNS OF GROUND OR BUILDING MOVEMENTS IN THE VICINITY OF EACH WORKING FRONT. IN ADDITION, THE OPTICAL MONITORING POINTS AT 40FT C/O ALONG THE TOP OF THE WALL SHOULD BE MONITORED NO LESS THAN ONCE PER WEEK DURING EXCAVATION AND TWICE A MONTH THEREAFTER UNTIL THE PERMANENT WALL IS COMPLETED. MONITORING REPORTS SHOULD BE CIRCULATED TO CONTRACTOR, ENGINEER AND OWNER WITHIN 24 HOURS OF DATA COLLECTION.

LONG TERM MONITORING OF THE PERFORMANCE OF THE SOIL NAIL WALL MAY BE ACHIEVED USING THE INCLINOMETERS INSTALLED BEHIND THE WALL, AND BY RECORDING OF THE LOADS WITHIN THE TWENTY SOIL NAILS EQUIPPED WITH LOAD MONITORING DEVICES. OPTICAL SURVEY MONITORING MAY ALSO BE USED TO MONITOR LONG TERM MOVEMENT OF THE SOIL NAIL WALL FACING.

LONG TERM MONITORING SHOULD BE PERFORMED AT NO LESS THAN TWICE PER YEAR FOR THE FIRST TWO YEARS OF SERVICE LIFE AND NO LESS THAN ONCE PER YEAR FOR THE FOLLOWING FIVE YEARS AND THEN ONCE EVERY FIVE YEARS THEREAFTER.

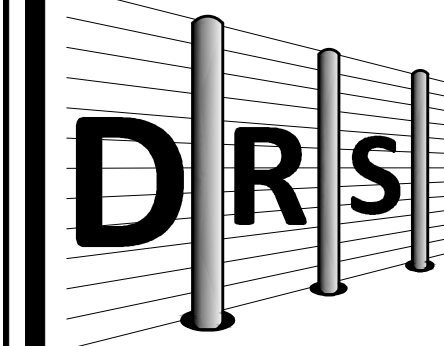

Engineering Inc.
 1024 PICO BLVD. STE. 05
 SANTA MONICA, CA 90405
 TEL: (818) 402-3562
 FAX: (818) 276-1922
 WWW.DRS-ENGINEERING.NET
 DRS@DRS-ENGINEERING.NET

PROJECT NAME
HARVARD-WESTLAKE

3701 GOLDWATER CANYON AVE
 GARDEN CITY
 CA 91904

GEOTECHNICAL CONSULTANTS
 BYER GEOTECHNICAL, INC.
 1605 E. CHEVY CHASE DR. #200
 GLENDALE
 CA 91201
 TEL: (818) 248-9999

CIVIL CONSULTANTS
 INNOVATIVE DESIGN GROUP
 17500 SRY PARK CIRCLE, SUITE D
 CA 90814
 TEL: (818) 303-3070

ARCHITECTURAL CONSULTANTS
 INNOVATIVE DESIGN GROUP
 17500 SRY PARK CIRCLE, SUITE D
 CA 90814
 TEL: (818) 303-3070

STRUCTURAL CONSULTANTS
 JOHN A. MARTIN & ASSOCIATES
 900 SOUTH GRAND AVE. 4TH FLOOR
 LOS ANGELES CA 90015
 TEL: (213) 483-6466

OWNER
 HARVARD-WESTLAKE SCHOOL
 700 N. FARMING RD.
 LOS ANGELES, CA 90077
 TEL: (310) 988-5259

**UPPER CAMPUS PARKING STRUCTURE
 PERMANENT SOIL NAIL WALL
 SECTIONS**

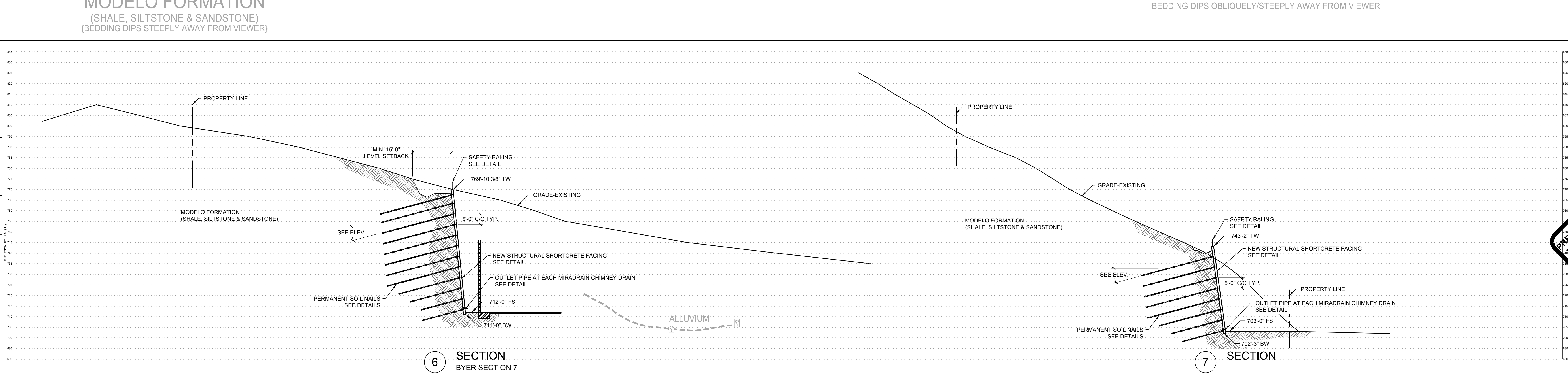
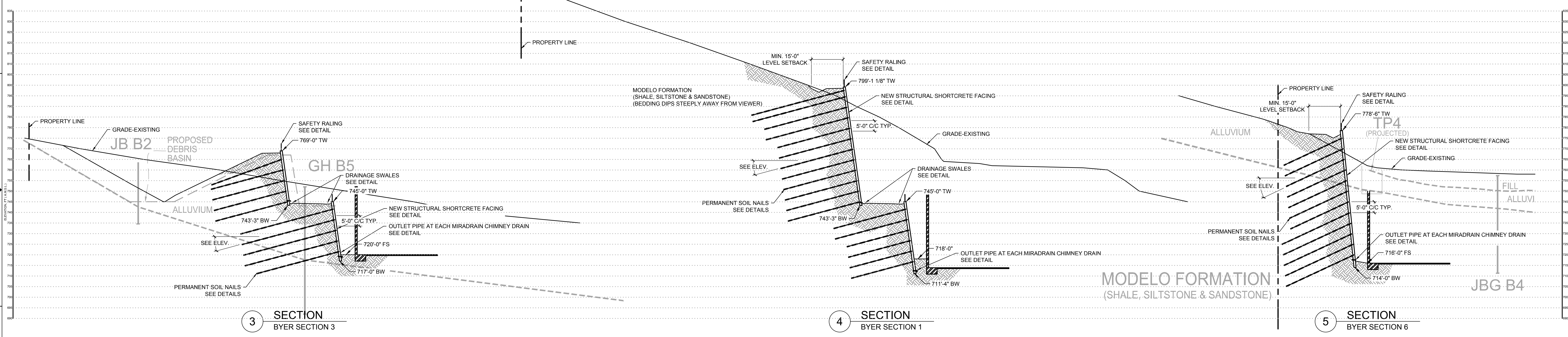
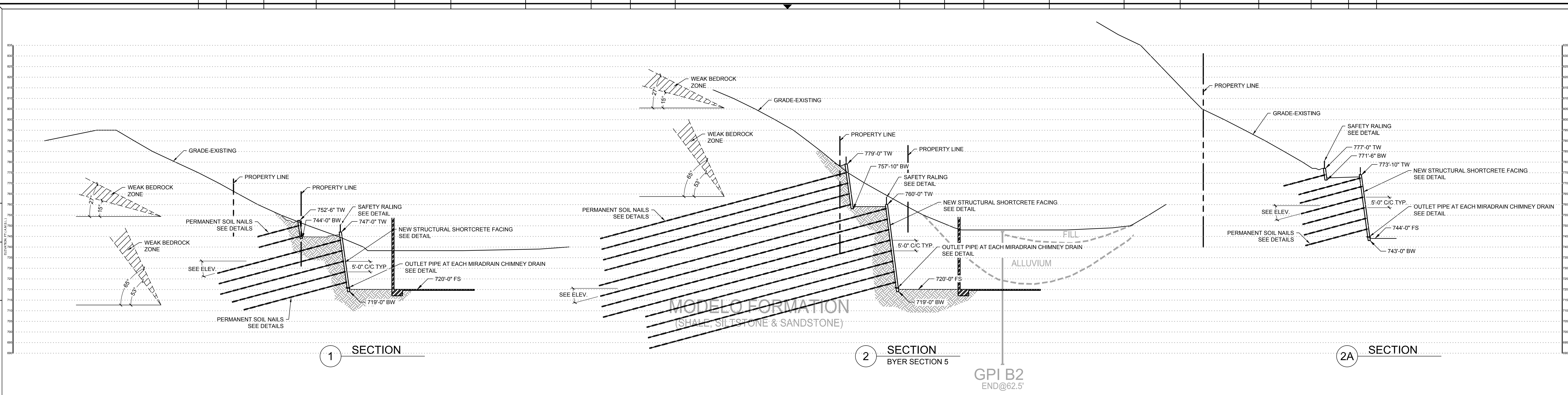

**PRELIMINARY CONCEPT ONLY TO
 SOIL NAIL SYSTEM
 NOT FOR CONSTRUCTION**

NO.	DESCRIPTION	DATE

DATE	05.18.2015
DRAWN	DRS - ODO
CHECKED	DRS
PROJECT No	2014-04
SHEET No.	SH-4.0

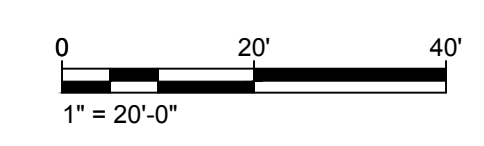

DESIGN ARRANGEMENTS, PLANS AND CONCEPTS INDICATED OR REPRESENTED BY THIS DOCUMENT ARE THE COPYRIGHTED PROPERTY OF DRS ENGINEERING, AND WERE CREATED, DEVELOPED EXCLUSIVELY FOR USE ON AND IN CONNECTION WITH THIS PROJECT. NONE OF THE SAID IDEAS, DESIGN ARRANGEMENTS OR PLANS SHALL BE USED BY OR DISCLOSED TO ANY PERSON, FIRM OR CORPORATION FOR ANY PURPOSE WHATSOEVER WITHOUT THE WRITTEN PERMISSION OF DRS ENGINEERING.

May 18, 2015
BG 21898

APPENDIX VIII

KPFF Consulting Engineers, Preliminary City of Los Angeles Low Impact Development (LID)
and Hydrology Study, both dated April 10, 2015

HYDROLOGY STUDY

**HARVARD-WESTLAKE SCHOOL
PARKING STRUCTURE**
3700 Coldwater Canyon
Studio City, CA 91604
KPFF Job # 109046

April 10, 2015



CLIENT:

Innovative Design Group
17848 Sky Park Circle, Suite D
Irvine, CA 92614
(949) 263-9070

PREPARED BY:

KPFF Consulting Engineers
6080 Center Drive, Suite 750
Los Angeles, California 90045
(310) 665-2800

TABLE OF CONTENTS

	<u>Page No.</u>
1. INTRODUCTION.....	1
2. HYDROLOGY.....	1
3. METHODOLOGY.....	2
3. ASSUMPTIONS.....	2
3. RESULT & CONCLUSIONS.....	2

EXHIBITS

EXHIBIT 1	Pre-Development Drainage Areas
EXHIBIT 2	Post-Development Drainage Areas
EXHIBIT 3	Preliminary Grading Plan
EXHIBIT 4	Sections

APPENDICES

Appendix "A"	Vicinity Map
Appendix "B"	Los Angeles County 50-year 24-hour Isohyet
Appendix "C"	Pre-Construction Hydrology Calculation (50 years, 25 years, 10 years, and 2 years)
Appendix "D"	Post-Construction Hydrology Calculation (50 years, 25 years, 10 years, and 2 years)

I. INTRODUCTION

The project consists of the design and construction of a new parking structure with an athletic field for Harvard-Westlake School at 3700 Coldwater Canyon Avenue, in Studio City, California. The new parking structure will be on the west side of Coldwater Canyon Avenue and will be connected to the existing campus via a pedestrian bridge that will span over Coldwater Canyon Avenue. A new athletic field and small facilities building will be included on the top level of the parking structure.

The project includes reconfiguration of the existing main campus entrance on the east side of Coldwater Canyon Avenue, as required to accommodate the pedestrian bridge access tower and reconfigured entrance roadway.

II. HYDROLOGY

The drainage area tributary to the project site is approximately 15.34 acres. The site is on an ascending hill with areas of steep and gradual slopes, which generally sloped from southwest to northeast direction. The drainage area is currently composed of natural landscape, driveways, small building facilities and exposed soil. The existing drainage area is approximately 90-95 % pervious while the proposed drainage area is approximately 86% pervious and 14% impervious. The existing runoff drains towards the northeast direction to Coldwater Canyon Avenue (see attached Exhibits 1 and 2).

With the construction of the parking structure, new athletic field and small facilities building, the proposed drainage system of the area is described as follows:

The surface runoff will be collected at multiple points through catch basins with filter inserts. The runoff generated from the exposed surfaces will be collected by drains and directed into flow-through planters. The flow-through planters are sized to treat the first flush volume of storm water, which is the greater of the first 0.75 inches of rainfall and the 85th percentile rainfall both multiplied by a factor of 1.5. The factor of 1.5 is a result of the infeasibility of infiltration due to the hillside grading ordinance. Flow-through planters are designed to treat and detain runoff without allowing seepage into the underlying soil. Pollutants are removed as the runoff passes through the soil layer and is collected in an underlying layer of gravel or drain rock. A perforated pipe underlain is piped to a storm drain which outlets to the street via 4" curb drain.

It is anticipated that in post construction, the new structure will not only help secure the previously exposed soil and natural landscaped areas from potential mudslides, but could also help slow high stormwater runoff flows from the adjacent hillside to Coldwater Canyon Avenue, especially during large storm events such as the Los Angeles County Capitol Flood 50 year storm. The new structure and supporting storm water management system infrastructure provide additional flood control and mudslide protection to Coldwater Canyon Avenue. Part of the mudslide infrastructure is a debris basin which is proposed to collect and provide temporary storage for 400 cubic yards per acre of mud/debris to meet Los Angeles Public - Building Code 2002-064. The debris basin is currently estimated to provide temporary storage for close to 8 acres. The area tributary to the basin is 7.38 acres. At the north end of the project, a swale to carry 10 cubic feet per second per acre is provided which will mitigate the supplementary required debris flow of 42.5 cubic feet per second. The swale to convey the supplementary

debris flow has a capacity of 51.53 cubic feet per second at the flattest section with a slope of 4% (see attached Exhibits 3 and 4).

Deflection walls have been added at the northwest corner of the parking structure. The walls are slanted at 30 degree angle to the adjacent contours to assist in directing mud/debris into the debris channel.

III. METHODOLOGY

Except where specified elsewhere in this report, the procedures, criteria, and standards as set forth in the Los Angeles County Hydrology Manual are utilized to perform pre and post construction hydrology study. See Appendix C and D for the calculation results.

Los Angeles County TC Calculator based on the Rational Method has been used to compute the peak runoff at pre-determined design points. The runoff analysis is based on the proposed land use, topographic features and proposed grading for the area. The average land slopes and runoff coefficients were used for computing the peak runoff.

The runoff equation for the Rational Method is as follows:

$$Q = CIA$$

- Where:
- Q = Peak runoff rate (CFS)
 - C = Runoff coefficient
 - I = Average rainfall intensity (in/hr)
 - A = Drainage area (acres)

IV. SUPPORT DOCUMENTS

The following documents were used to prepare this report:

- a. The drainage areas are determined using the topographic survey for the project site as well as publically available topographic maps for tributary run-on areas. The topographic survey was provided by Iacobellis and Associates, Inc dated July 1, 2009 and public information was obtained using Google Earth Pro.
- b. The extent of project development is based on the site plan provided by Innovative Design Group dated October 7, 2014

V. RESULTS & CONCLUSIONS

Using the Rational Method per Los Angeles County Hydrology Manual, the calculated 50, 25, 10, and 2 year storm pre-construction runoff rates are approximately 60, 52, 38, and 11 cfs respectively. The calculated 50, 25, 10, and 2 year storm post-construction runoff rates are approximately 60, 52, 39, and 15 cfs respectively. The resulting flows indicate that the proposed development will not affect the runoff rates before and after the construction for 50 and 25 year storm events. For smaller storm frequency of 10 and 2 year, it shows a slight increase in runoff due to the increase in impervious surfaces. However, the peak mitigated runoff and volume from the proposed development areas will be captured and treated by appropriate Best Management Practices (BMPs) before discharging into the road. Refer to the project Low Impact Development (LID) for details.

EXHIBIT 1
PRE-DEVELOPMENT DRAINAGE AREAS

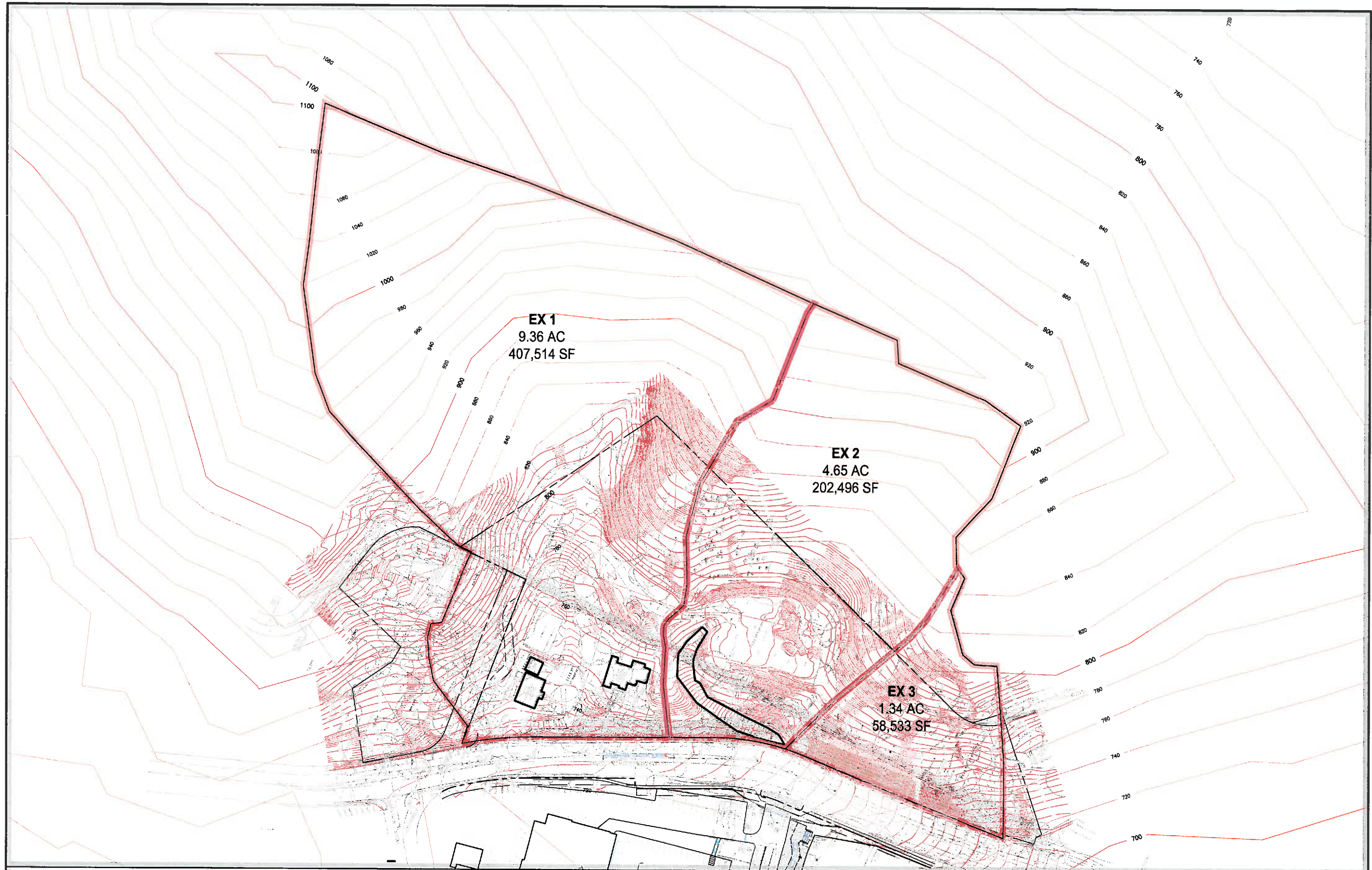

EX 1
9.36 AC
407,514 SF

EX 2
4.65 AC
202,496 SF

EX 3
1.34 AC
58,533 SF

HARVARD-WESTLAKE SCHOOL PARKING STRUCTURE
EXHIBIT 1 - PRE-DEVELOPMENT DRAINAGE AREAS
04/10/15

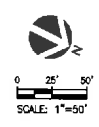

EXHIBIT 2
POST-DEVELOPMENT DRAINAGE AREAS



- A1**
0.67 AC
29,278 SF
- A2**
3.58 AC
156,099 SF
- A3**
7.38 AC
321,484 SF
- A4 BLDG**
1.92 AC
83,779 SF
- A5**
0.17 AC
7,503 SF
- A6**
0.34 AC
14,975 SF
- A7**
0.44 AC
19,010 SF
- A8**
0.84 AC
36,415 SF

HARVARD-WESTLAKE SCHOOL PARKING STRUCTURE
EXHIBIT 2 - POST-DEVELOPMENT DRAINAGE AREAS
04/10/15

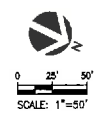
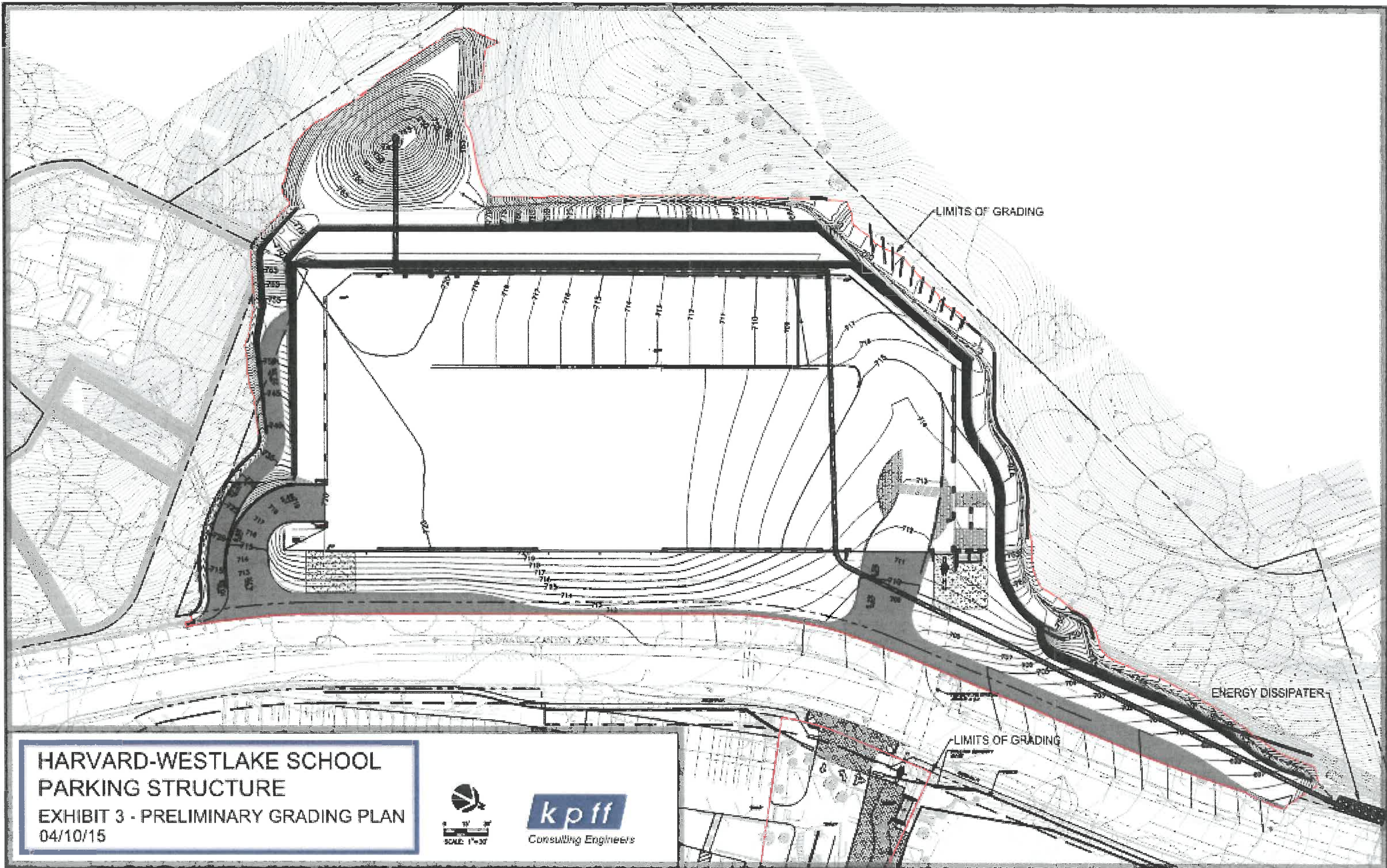

EXHIBIT 3
PRELIMINARY GRADING PLAN



HARVARD-WESTLAKE SCHOOL
PARKING STRUCTURE
EXHIBIT 3 - PRELIMINARY GRADING PLAN
04/10/15



LIMITS OF GRADING

ENERGY DISSIPATER

LIMITS OF GRADING

EXHIBIT 4
SECTIONS

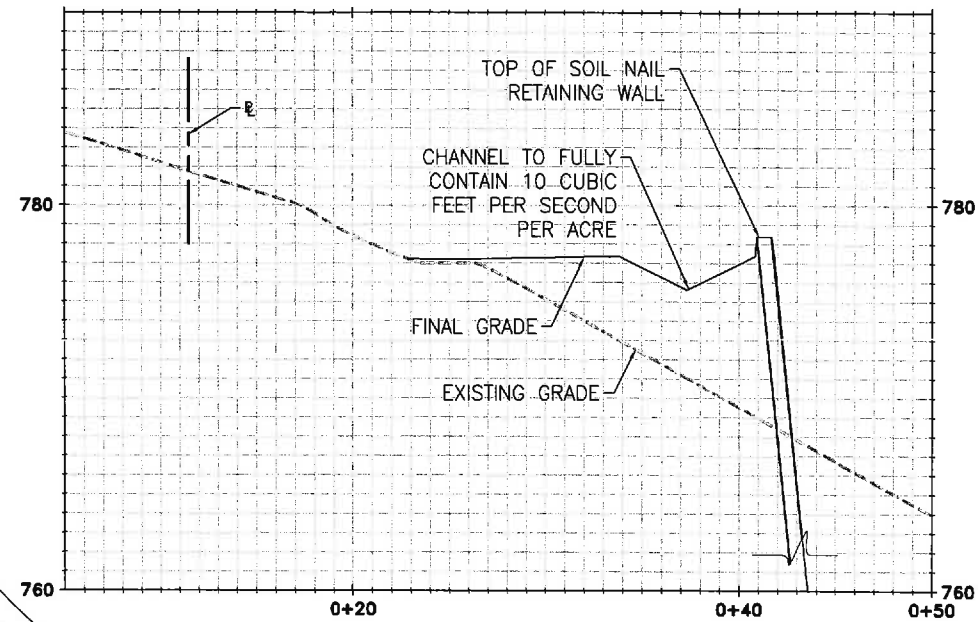
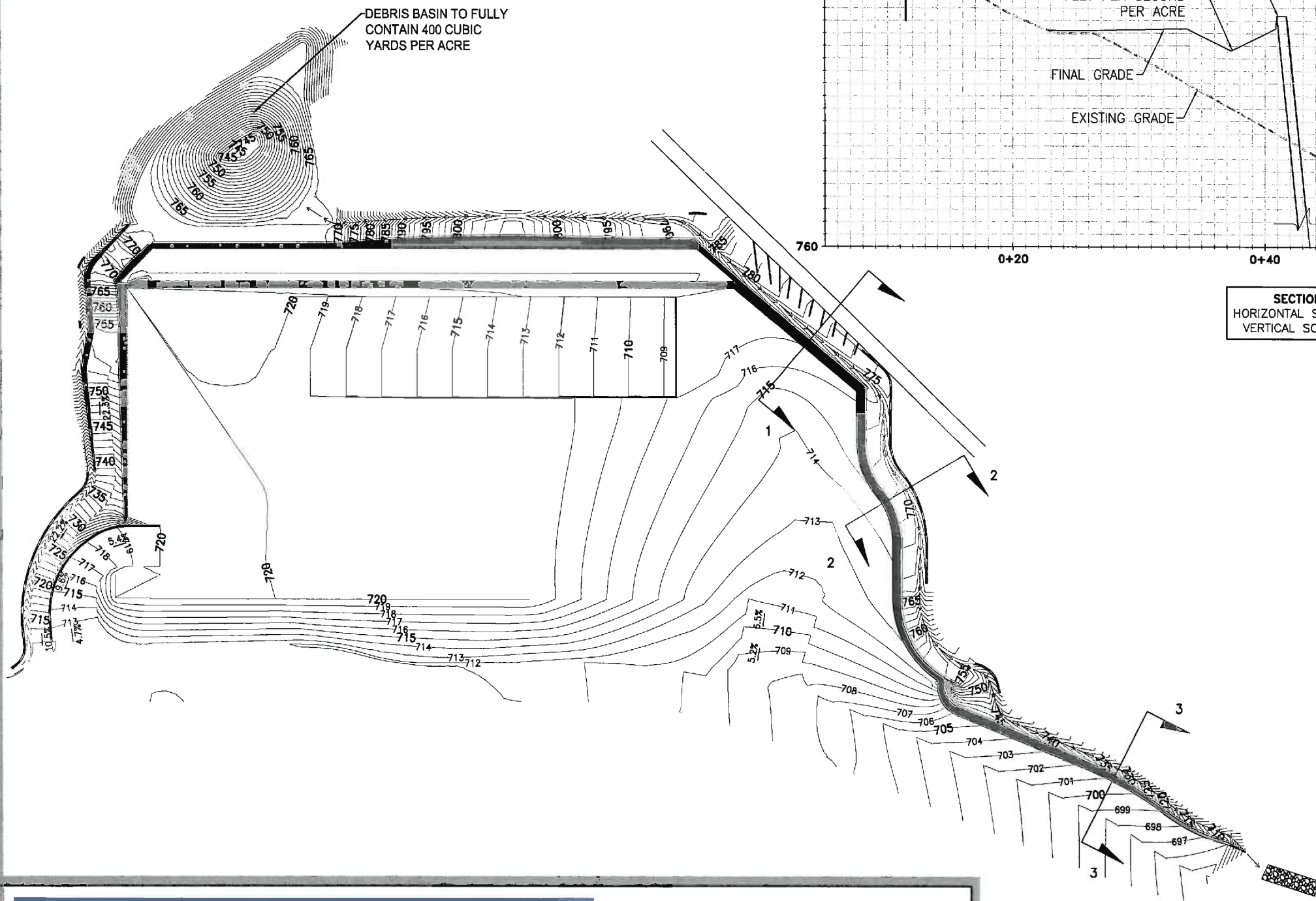

SECTION 1-1
 HORIZONTAL SCALE: 1"=5'
 VERTICAL SCALE: 1"=5'

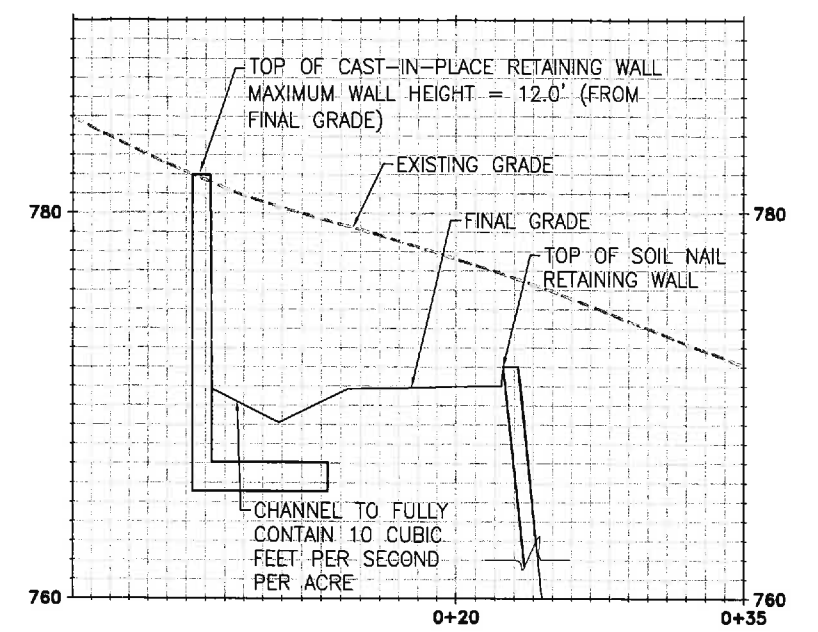

SECTION 2-2
 HORIZONTAL SCALE: 1"=5'
 VERTICAL SCALE: 1"=5'

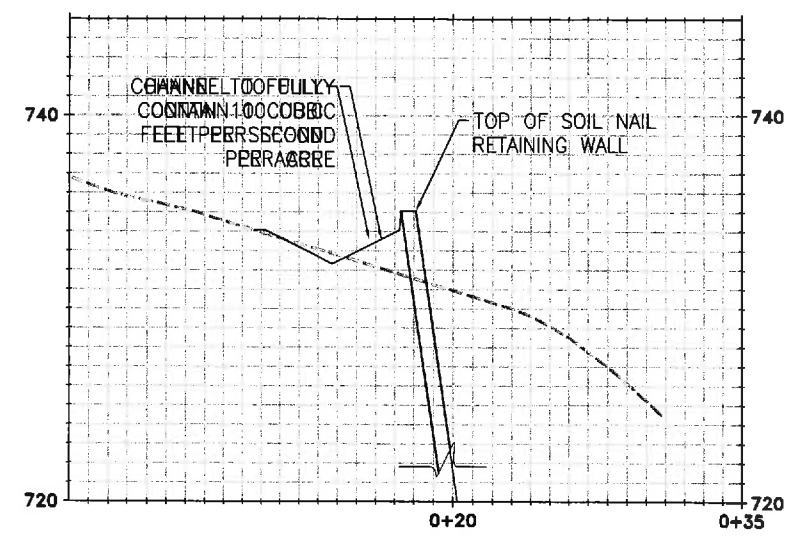

SECTION 3-3
 HORIZONTAL SCALE: 1"=5'
 VERTICAL SCALE: 1"=5'

**HARVARD-WESTLAKE SCHOOL
 PARKING STRUCTURE**
 EXHIBIT 4 - SECTIONS
 04/10/15

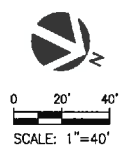

Appendix “A”

Vicinity Map

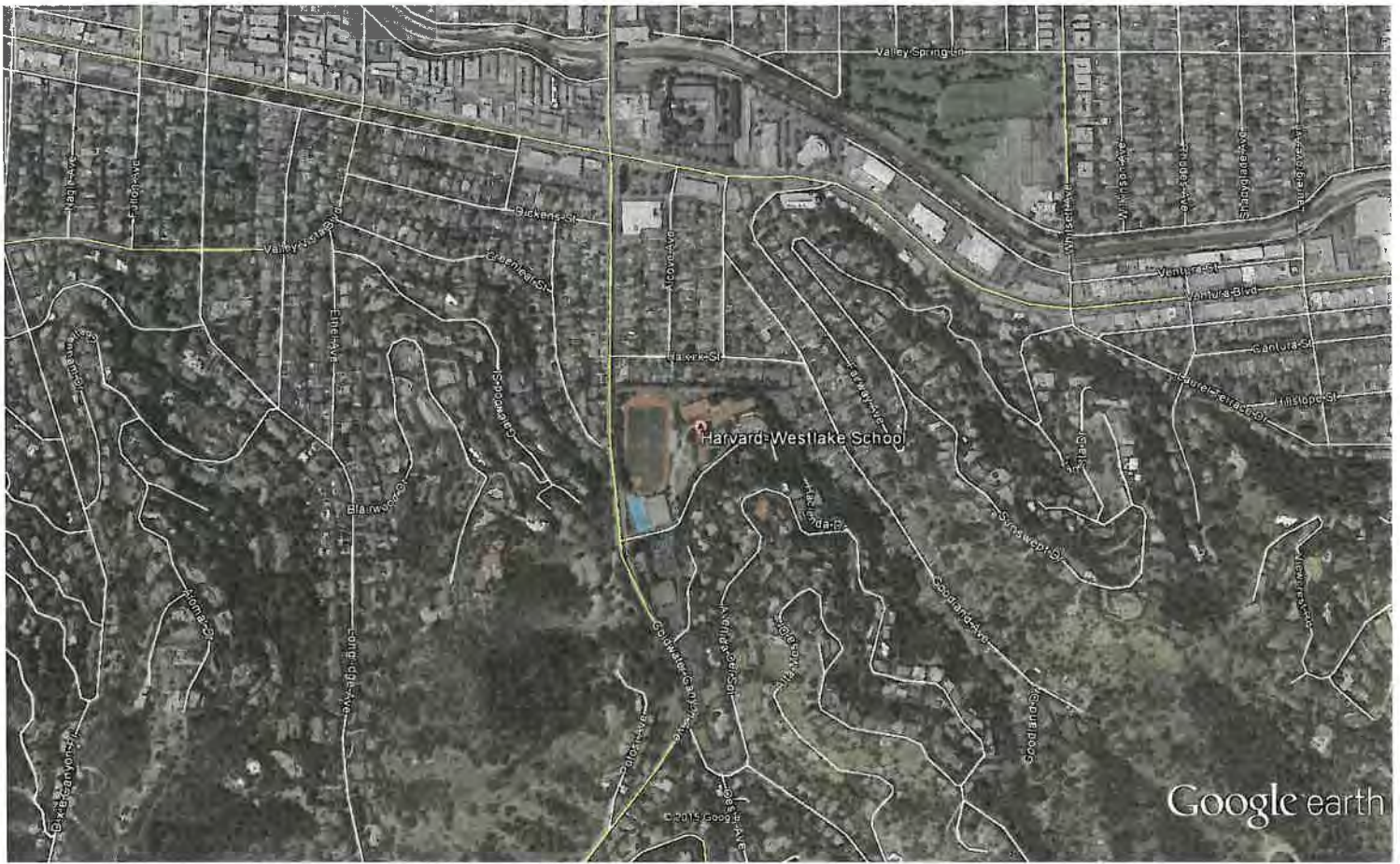

PROJECT SITE

VICINITY MAP

NOT TO SCALE

THOMAS GUIDE **LOS ANGELES** EDITION

PAGE: **562** GRID: **E6**

Appendix “B”

Los Angeles County 50-year 24-hour Isohyet

34° 15' 00"

SAN FERNANDO 1-HI.36

-118° 30' 00"

CANOGA PARK 1-HI.26

BURBANK 1-HI.28

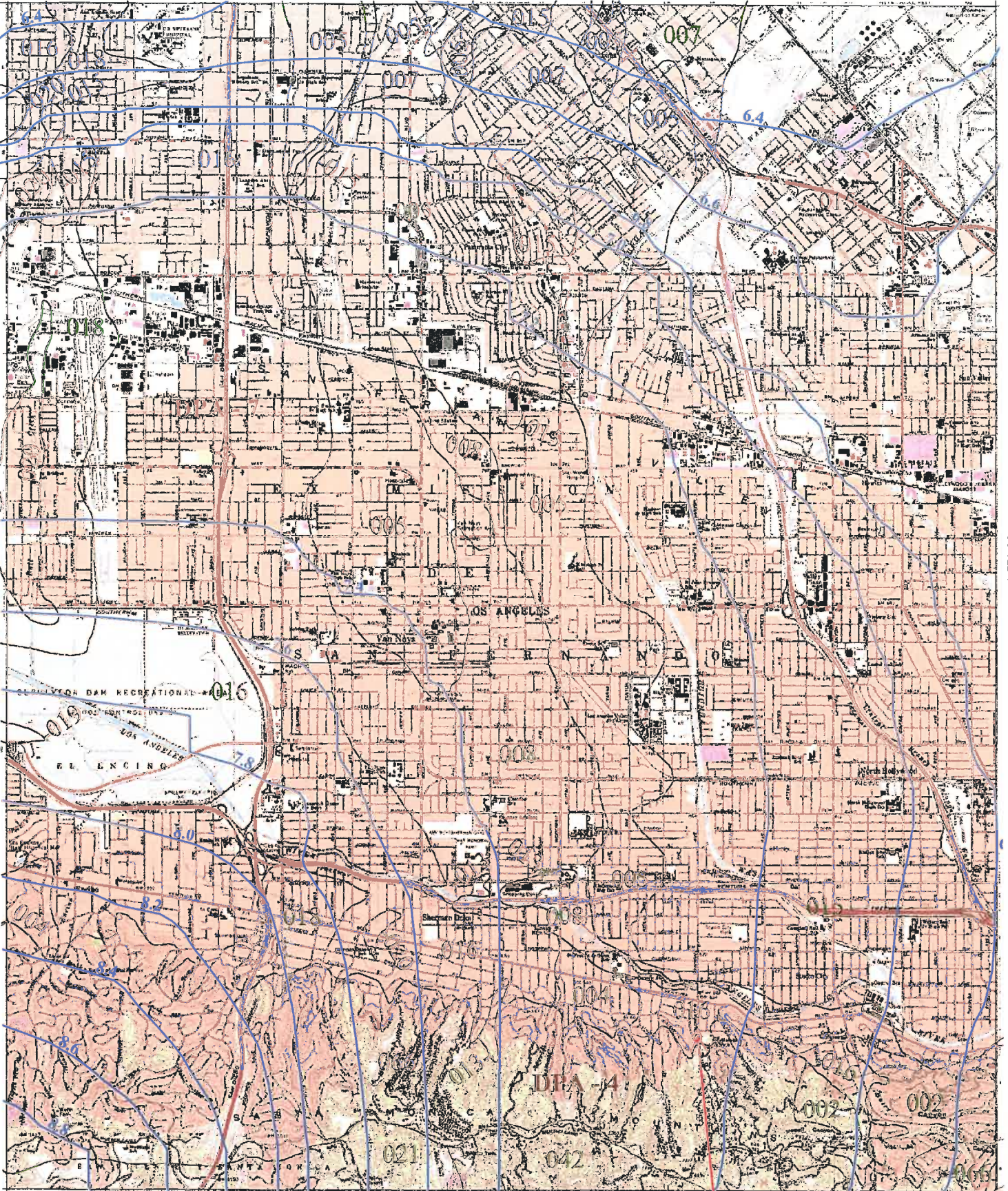

BEVERLY HILLS 1-HI.17

34° 07' 30"

-118° 22' 30"



016

SOIL CLASSIFICATION AREA

7.2

INCHES OF RAINFALL

DPA - 6

DEBRIS POTENTIAL AREA

1 0 1 2 Miles

25-YEAR 24-HOUR ISOHYET REDUCTION FACTOR: 0.878
10-YEAR 24-HOUR ISOHYET REDUCTION FACTOR: 0.714

VAN NUYS

50-YEAR 24-HOUR ISOHYET

PROJECT SITE

1-HI.27



Appendix "C"

**Pre-Construction Hydrology Calculation
(50 years, 25 years, 10 years, and 2 years)**

Summary of TC - Calculator Results Existing

2 - Year Storm													
Subarea	Area (acres)	%imp	Frequency	Soil Type	Length (ft)	Slope (ft/ft)	Isohyet (in.)	Tc-calc. (min.)	Intensity (in./hr)	Cu	Cd	Flow rate (cfs)	Volume (acre-ft)
1	9.36	0	2	16	980	0.5	2.8	12	1.11	0.57	0.57	5.92	0.31
2	4.65	0	2	16	615	0.36	2.8	9	1.27	0.61	0.61	3.6	0.15
3	1.34	0	2	16	240	0.5	2.8	5	1.67	0.7	0.7	1.57	0.04
Σ												11.09	0.5

10 - Year Storm													
Subarea	Area (acres)	%imp	Frequency	Soil Type	Length (ft)	Slope (ft/ft)	Isohyet (in.)	Tc-calc. (min.)	Intensity (in./hr)	Cu	Cd	Flow rate (cfs)	Volume (acre-ft)
1	9.36	0	10	16	980	0.5	5.2	6	2.85	0.84	0.84	22.41	0.73
2	4.65	0	10	16	615	0.36	5.2	5	3.1	0.85	0.85	12.25	0.37
3	1.34	0	10	16	240	0.5	5.2	5	3.1	0.85	0.85	3.53	0.11
Σ												38.19	1.21

25 - Year Storm													
Subarea	Area (acres)	%imp	Frequency	Soil Type	Length (ft)	Slope (ft/ft)	Isohyet (in.)	Tc-calc. (min.)	Intensity (in./hr)	Cu	Cd	Flow rate (cfs)	Volume (acre-ft)
1	9.36	0	25	16	980	0.5	6.4	5	3.82	0.89	0.89	31.82	1.02
2	4.65	0	25	16	615	0.36	6.4	5	3.82	0.89	0.89	15.81	0.51
3	1.34	0	25	16	240	0.5	6.4	5	3.82	0.89	0.89	4.56	0.15
Σ												52.19	1.68

50 - Year Storm													
Subarea	Area (acres)	%imp	Frequency	Soil Type	Length (ft)	Slope (ft/ft)	Isohyet (in.)	Tc-calc. (min.)	Intensity (in./hr)	Cu	Cd	Flow rate (cfs)	Volume (acre-ft)
1	9.36	0	50	16	980	0.5	7.25	5	4.33	0.9	0.9	36.48	1.25
2	4.65	0	50	16	615	0.36	7.25	5	4.33	0.9	0.9	18.12	0.62
3	1.34	0	50	16	240	0.5	7.25	5	4.33	0.9	0.9	5.22	0.18
Σ												59.82	2.05

Appendix “D”

Post-Construction Hydrology Calculation

(50 years, 25 years, 10 years, and 2 years)

Summary of TC - Calculator Results Proposed

2 - Year Storm													
Subarea	Area (acres)	%imp	Frequency	Soil Type	Length (ft)	Slope (ft/ft)	Isohyet (in.)	Tc-calc. (min.)	Intensity (in./hr)	Cu	Cd	Flow rate (cfs)	Volume (acre-ft)
1	0.67	0	2	16	180	0.5	2.8	5	1.67	0.7	0.7	0.79	0.02
2	3.58	0	2	16	365	0.6	2.8	6	1.53	0.68	0.68	3.73	0.11
3	7.38	0	2	16	665	0.2	2.8	11	1.15	0.58	0.58	4.92	0.24
4	1.92	100	2	16	215	0.02	2.8	6	1.53	0.68	0.9	2.65	0.4
5	0.17	0	2	16	90	0.65	2.8	5	1.67	0.7	0.7	0.2	0.01
6	0.34	15	2	16	110	0.6	2.8	5	1.67	0.7	0.9	0.52	0.07
7	0.44	0	2	16	25	0.05	2.8	5	1.67	0.7	0.7	0.51	0.01
8	0.84	20	2	16	70	0.05	2.8	5	1.67	0.7	0.9	1.26	0.17
Σ												14.58	1.03

10 - Year Storm													
Subarea	Area (acres)	%imp	Frequency	Soil Type	Length (ft)	Slope (ft/ft)	Isohyet (in.)	Tc-calc. (min.)	Intensity (in./hr)	Cu	Cd	Flow rate (cfs)	Volume (acre-ft)
1	0.67	0	10	16	180	0.5	5.2	5	3.1	0.85	0.85	1.77	0.05
2	3.58	0	10	16	365	0.6	5.2	5	3.1	0.85	0.85	9.44	0.28
3	7.38	0	10	16	665	0.2	5.2	6	2.85	0.84	0.84	17.67	0.58
4	1.92	100	10	16	215	0.02	5.2	5	3.1	0.85	0.9	5.37	0.74
5	0.17	0	10	16	90	0.65	5.2	5	3.1	0.85	0.85	0.45	0.01
6	0.34	15	10	16	110	0.6	5.2	5	3.1	0.85	0.9	0.96	0.13
7	0.44	0	10	16	25	0.05	5.2	5	3.1	0.85	0.85	1.15	0.03
8	0.84	20	10	16	70	0.05	5.2	5	3.1	0.85	0.9	2.33	0.32
Σ												39.14	2.14

25 - Year Storm													
Subarea	Area (acres)	%imp	Frequency	Soil Type	Length (ft)	Slope (ft/ft)	Isohyet (in.)	Tc-calc. (min.)	Intensity (in./hr)	Cu	Cd	Flow rate (cfs)	Volume (acre-ft)
1	0.67	0	25	16	180	0.5	6.4	5	3.82	0.89	0.89	2.29	0.07
2	3.58	0	25	16	365	0.6	6.4	5	3.82	0.89	0.89	12.18	0.39
3	7.38	0	25	16	665	0.2	6.4	5	3.82	0.89	0.89	25.09	0.81
4	1.92	100	25	16	215	0.02	6.4	5	3.82	0.89	0.9	6.61	0.92
5	0.17	0	25	16	90	0.65	6.4	5	3.82	0.89	0.89	0.59	0.02
6	0.34	15	25	16	110	0.6	6.4	5	3.82	0.89	0.9	1.18	0.16
7	0.44	0	25	16	25	0.05	6.4	5	3.82	0.89	0.89	1.48	0.05
8	0.84	20	25	16	70	0.05	6.4	5	3.82	0.89	0.9	2.87	0.4
Σ												52.29	2.82

50 - Year Storm													
Subarea	Area (acres)	%imp	Frequency	Soil Type	Length (ft)	Slope (ft/ft)	Isohyet (in.)	Tc-calc. (min.)	Intensity (in./hr)	Cu	Cd	Flow rate (cfs)	Volume (acre-ft)
1	0.67	0	50	16	180	0.5	7.25	5	4.33	0.9	0.9	2.62	0.09
2	3.58	0	50	16	365	0.6	7.25	5	4.33	0.9	0.9	13.97	0.48
3	7.38	0	50	16	665	0.2	7.25	5	4.33	0.9	0.9	28.76	0.99
4	1.92	100	50	16	215	0.02	7.25	5	4.33	0.9	0.9	7.5	1.04
5	0.17	0	50	16	90	0.65	7.25	5	4.33	0.9	0.9	0.67	0.02
6	0.34	15	50	16	110	0.6	7.25	5	4.33	0.9	0.9	1.34	0.19
7	0.44	0	50	16	25	0.05	7.25	5	4.33	0.9	0.9	1.7	0.06
8	0.84	20	50	16	70	0.05	7.25	5	4.33	0.9	0.9	3.26	0.45
Σ												59.82	3.32

**PRELIMINARY
CITY OF LA
LOW IMPACT DEVELOPMENT
(LID)**

**HARVARD-WESTLAKE SCHOOL
PARKING STRUCTURE**
3700 Coldwater Canyon Ave.
Studio City, CA 91604
KPFF Job # 109046

April 10, 2015



CLIENT:

Innovative Design Group
17848 Sky Park Circle, Suite
Irvine, CA 92614

PREPARED BY:

KPFF Consulting Engineers
6080 Center Drive, Suite 750
Los Angeles, California 90045
(310) 665-2800

TABLE OF CONTENTS

	<u>Page No.</u>
I. INTRODUCTION	1
A. Project Description	
B. Drainage Characteristics	
C. Peak Mitigated Discharge Values	
II. BEST MANAGEMENT PRACTICES (BMPs)	2-3
A. Structural BMPs	
1. Kristar FloGard Plus Catch Basin Filter Insert	
2. Flow-through Planter Box	
B. Non-structural BMPs	
1. Maintenance Areas	
2. Education and Training	
3. Landscaping	
4. Monitoring and Maintenance	

EXHIBIT

EXHIBIT 1 Preliminary LID Plan

APPENDICES

Appendix "A" LID Calculations
Appendix "B" Operation & Maintenance Plan
Appendix "C" Storm Drain Stenciling and Signage

REFERENCES

Development Best Management Practices Handbook, 4th Edition. City of Los Angeles Public Works, May 2012.

Los Angeles County Standard Urban Storm Water Mitigation Plan. Los Angeles County Department of Public Works, September 2002.

I. INTRODUCTION

A. Project Description

The project consists of the design and construction of a new parking structure with an athletic field for Harvard-Westlake School at 3700 Coldwater Canyon Avenue, in Studio City, California. The new parking structure will be on the west side of Coldwater Canyon Avenue and will be connected to the existing campus via a pedestrian bridge that will span over Coldwater Canyon Avenue. A new athletic field and small facilities building will be included on the top level of the parking structure.

The project includes reconfiguration of the existing main campus entrance on the east side of Coldwater Canyon Avenue, as required to accommodate the pedestrian bridge access tower and reconfigured entrance roadway.

The City of Los Angeles B-permit will be required to improve approximately 1,300 linear feet of Coldwater Canyon Avenue along the project frontage. B-permit work will include street widening for new turn lanes, relocation of an existing signal and access road, and new driveways for the proposed parking structure.

B. Drainage Characteristics

- Total drainage area including tributary run-ons = 15.34 acres
- Project site area = 6.66 acres
- Disturbed area for new improvements and grading = 3.2 acres
- New hardscape area = 2.0 acres
- New driveway and road = 0.36 acres (considered to be pervious concrete pavement)

Refer to the project Hydrology Study for the entire drainage area and runoff calculations.

The site is on an ascending hill with areas of steep and gradual slopes, which generally sloped from southwest to northeast direction. The drainage area is currently composed of natural landscape, driveways, small building facilities and exposed soil. The proposed development area is approximately 65.3% impervious and 34.7% pervious. The existing runoff drains towards the northeast direction to Coldwater Canyon Avenue.

With the construction of the parking structure, new athletic field and small facilities building, the proposed drainage system of the area is described as follows:

The surface runoff will be collected at multiple points through catch basins with filter inserts. The runoff generated from the exposed surfaces will be collected by drains and directed into flow-through planters. The flow-through planters are sized to treat the first flush volume of storm water, which is the greater of the first 0.75 inches of rainfall and the 85th percentile rainfall both multiplied by a factor of 1.5. The factor of 1.5 is a result of the infeasibility of infiltration due to the hillside grading ordinance. Flow-through planters are designed to treat and detain runoff without allowing seepage into the underlying soil. Pollutants are removed as the runoff passes through the soil layer and is collected in an underlying layer of gravel or drain

rock. A perforated pipe underlain is piped to a storm drain which outlets to the street via 4" curb drain. See attached Exhibit 1 for potential location of flow-through planters.

Pollutants of concern include trash, dried leaves, twigs from the trees and shrubs, silt, pesticides and fertilizers in the planter areas.

C. Peak Mitigated Discharge Values

The peak mitigated discharge value (Q_{PM}) has been calculated to be 1.48 cfs or an equivalent volume of 10,296 cf. The values were determined based on the Los Angeles County Department of Public Works method for calculating standard urban stormwater mitigation plan flow rates and volumes using the greater of the first 0.75 inches of rainfall and the 85th percentile rainfall both multiplied by a factor of 1.5. The factor of 1.5 is a result of the infeasibility of infiltration due to the hillside grading ordinance.

Table 1: Summary of Flow-through Planter Box Calculations

Area Disturbed (Acres)	Flow to be Treated (CFS)	Volume to be Treated (CF)	Planter Box Required (SF)	Planter Box Provided (SF)
3.2	1.48	10,296	7,676	9,100

Detailed input parameters and calculations are shown in Appendix "A".

II. BEST MANAGEMENT PRACTICES (BMPs)

The following is a list of all BMP's to be implemented onsite:

A. Structural BMPs

1. Kristar FloGard Plus Catch Basin Filter Inserts

Kristar Catch Basin Filter Inserts, LA City research reference RR#5591 and LA City approval reference RR#5584, by KriStar Enterprises, Inc. will be installed in catch basins as structural BMPs for removal of silt and debris in storm water runoff. These filter inserts have been selected to accommodate, up to and including, the 85th percentile storm event multiplied by a factor of 1.5.

2. Flow-through Planter Box

In addition to the catch basin filter insert, a flow-through planter box is proposed as a structural BMP for the removal of silt and debris in storm water runoff. The flow-through planter box has been designed to accommodate, up to and including, the 85th percentile storm event multiplied by a factor of 1.5. See Exhibit 1 and Appendix "A" for details and calculations.

3. Permeable Pavement

Pervious concrete pavement along with permeable brick pavers will be considered in the final design to assist with decreasing the post-construction impervious areas. It is important to note

that these pavement sections will require a geotextile liner along with an under-drain system to mitigate large storm events.

B. Non-structural BMPs

1. Open Paved Areas and Planter Areas

- a. Regular sweeping of all open and planter areas, at a minimum, on a weekly basis in order to prevent dispersal of pollutants that may collect on those surfaces.
- b. Regular pruning of the trees and shrubs in the planter areas to avoid formation of dried leaves and twigs, which are normally blown by the wind during windy days. These dried leaves are likely to clog the surface inlets of the drainage system when rain comes, which would result to flooding of the surrounding area due to reduced flow capacities of the inlets.
- c. Trash and recycling containers shall be used such that, if they are to be located outside or apart from the principal structure, are fully enclosed and watertight in order to prevent contact of storm water with waste matter, which can be a potential source of bacteria and other pollutants in runoff. These containers shall be emptied and the wastes disposed of properly on a regular basis.

2. Education and Training

The owners shall be made aware of the structural BMPs installed in the project. Information materials, such as brochures, shall also be provided for their complete information. They shall also be briefed about chemical management and proper methods of handling and disposal of wastes and should understand the on-site BMPs and their maintenance requirements.

3. Landscaping

Minimize the use of pesticides and fertilizers to the maximum extent practical.

4. Monitoring and Maintenance

- a. All BMPs shall be operated, monitored, and maintained for the life of the project and at a minimum, all structural BMPs shall be inspected, cleaned-out, and where necessary, repaired, at the following minimum frequencies: 1) prior to October 15th each year; 2) during each month between October 15th and April 15th of each year and, 3) at least twice during the dry season (between April 16 and October 14 of every year).
- b. Maintenance procedures and recommendations outlined by KriStar Enterprises, Inc. shall be followed by the owner to ensure proper performance of the filter insert.
- c. Debris and other water pollutants removed from structural BMPs during cleanout shall be contained and disposed of in a proper manner.

d. The drainage system and the associated structures and BMPs shall be maintained according to manufacturer's specification to ensure maximum pollutant removal efficiencies (see Appendix "B").

EXHIBIT 1

PRELIMINARY LID PLAN

APPENDIX A

LID CALCULATIONS

**Calculation Steps for Determining Peak Mitigated Flow Rate Post Construction
Only the development areas are considered (Sub-Areas 4, 7 & 8 per Hydrology Study)**

Soil Type: 16

**85th Percentile
24 hour storm**

1. Assume an initial Tc value between 5 and 30 minutes.

Tc = 10 minutes

2. Using Table 1, look up the assumed Tc value and select the corresponding Ix intensity in inches/hour.

Ix = 0.495 in/hr

3. Determine the value for the Undeveloped Runoff Coefficient, Cu, using the runoff coefficient curve corresponding to the predominant soil type.

Cu = 0.10

4. Calculate the Developed Runoff Coefficient, Cd = (0.9 * % Imp.) + [(1.0 - % Imp.) * Cu]

% Imp. = 65.3%

Cd = 0.62

5. Calculate the value for Cd * Ix

Cd * Ix = 0.308

6. Calculate the time of concentration, Tc = 10^{-0.507} * (Cd * Ix)^{-0.519} * Length^{0.483} * Slope^{-0.135}

Length = 150.8 ft

Slope = 3.20%

Calculated Tc = 10.3 minutes

7. Calculate the difference between the initially assumed Tc and the calculated Tc, if the difference is greater than 0.5 minutes. Use the calculated Tc as the assumed initial Tc in the second iteration. If the Tc value is within 0.5 minutes, round the acceptable Tc value to the nearest minute. If Tc is greater than 30 minutes, Use 30.

Iteration No.	Initial Tc (min.)	Ix (in/hr)	Cu	Cd	Cd * Ix (in/hr)	Calculated Tc (min)	Difference
1	10	0.4953555	0.10	0.62	0.308	10.3	0.3

Acceptable Tc Value = 10 minutes

8. Calculate the Peak Mitigation Flow Rate;

Qpm = Cd * Ix * Atotal * (1.008333 ft³-hour / acre-inches-seconds)

Atotal = 3.20 acre

Qpm = 0.99 cfs	x1.5 =	1.48 CFS
----------------	--------	----------

9. Vm = (3448.5 ft³ / acre) * [(Ai) (0.9) + (Ap + Au) (Cu)]

Ai = 2.09 acres

Ap = 1.11 acres

Au = 0 acres

Vm = 6863.89 cf	x1.5 =	10295.84 CF
-----------------	--------	-------------

Planter Box Sizing

Note: Red values to be changed by user.
Black values are automatically calculated.

Only the development areas are considered (Sub-Areas 4, 7, & 8 per Hydrology Study)

[1]	Total Area (SF)		139204
[2]	Impervious Area (SF)		91062
[3]	Pervious Area (SF)	$[1]-[2] =$	48142
[4]	Catchment Area (SF)	$([2]*0.9)+([3]*0.1) =$	86770
[5]	Design Rainfall Depth (in)	Greater of 0.75", 85th percentile	1.15
[6]	V_{design} (CF)	$1.5*[5]/12*[4] =$	12473
[7]	$K_{sat,media}$ (in/hr)		5.0
[8]	FS	Use 6 if no geotech investigation	2.0
[9]	$K_{sat,design}$ (in/hr)	$[7]/[8] =$	2.5
[10]	$d_{p,max}$, Max. Ponding Depth (ft)	$MIN(1, [9]*48/12) =$	1.0
[11]	d_p , Ponding Depth (ft)	1' max.	1.0
[12]	T_{fill} (hr)		3
[13]	A_{min} (sq. ft)	$[6]/([9]*[12]/12 + [11])$	7676

Source: LID Handbook, City of LA (May 2012)

APPENDIX B

OPERATION AND MAINTENANCE PLAN

Operation and Maintenance Plan

- a. All BMPs will be operated, monitored, and maintained for the life of the project and at a minimum, all structural BMPs shall be inspected, cleaned-out, and where necessary, repaired, at the following minimum frequencies: 1) prior to October 15th each year; 2) during each month between October 15th and April 15th of each year and, 3) at least twice during the dry season (between April 16 and October 14 of every year).
- b. Debris and other water pollutants removed from structural BMPs during cleanout will be contained and disposed of in a proper manner.

Specific Operation and Maintenance Plan for Flow-Through Planter

The inspection and maintenance program will include the following key components: Filtration planters remove storm water pollutants through a combination of overland flow through vegetation, surface detention, and filtration through soil. Frequent inspection and maintenance is required until vegetation becomes established. Thereafter, routine maintenance requirements are considered minimal.

Typical routine maintenance consists of the following:

- a. Inspect soil and plantings. Remove weeds, prune vegetation and replenish mulch as needed. Clear any obstructions and remove any accumulation of sediment.
- b. Inspect side slopes for evidence of instability or erosion and correct as necessary.
- c. Observe soil at the bottom of the ponding area for uniform percolation throughout. If portions of the area do not drain within 48 hours after the end of a storm, the soil should be tilled and replanted. Remove any debris or accumulated sediment.
- d. Examine the vegetation to ensure that it is healthy and dense enough to provide filtering and to protect soils from erosion. Confirm that irrigation is adequate and not excessive. Replace dead plants and remove invasive vegetation.
- e. Abate any potential vectors by filling holes in the surface and around the ponding area. If mosquito larvae are present and persistent, contact the County Vector Control District for information and advice. Mosquito larvicides should be applied only when absolutely necessary and then only by a licensed individual or contractor.

Specific Operation and Maintenance Plan for Catch Basin Filter Inserts

-See attached Manufacturer's recommendations.



Removes pollutants from runoff prior to entering waterways

Efficient

catches pollutants where they are easiest to catch, at the inlet.

Two-part insert to filter solids and oil/grease

Variable Design

applications with the ability to be retrofitted or used in new projects.

Treatment Train

can be incorporated as part of a "Treatment Train".

No Standing Water

helps to minimize vector, bacteria and odor problems.

Focused Treatment

removes petroleum hydrocarbons, trash, and TSS.

Maximum Flexibility

available in a variety of standard sizes to fit round and square inlets.

Economical

Receive a higher return on investment.



Easy to install, inspect and maintain, even on small and confined sites

By the Numbers*:

- Filter shall remove 80% of total suspended solids (TSS)
- Capture at least 70% of oil and grease and 40% of total phosphorus (TP) associated with organic debris.

**approx. for urban street application*

Catch Basin Filter Test Results Summary

Testing Agency	% TSS Removal	% Oil & Grease Removal	% PAH Removal
UCLA	80	70 to 80	
U of Auckland			
Tonking & Taylor, Ltd. (for City of Auckland)	78 to 95		
U of Hawaii (for city of Honolulu)	80		20 to 40



Multipurpose Catch Basin Insert designed to capture sediment, debris, trash & oils/grease from low (first flush) flows, even during the most extreme weather conditions.

The FloGard® Catch Basin Insert Filters provide solids filtration through a filter screen or filter liner, and hydrocarbon capture shall be effected using a non-leaching absorbent material contained in a pouch or similar removable restraint. They are recommended for areas subject to silt and debris as well as low-to-moderate levels of petroleum hydrocarbons (oils and grease). Examples of such areas are vehicle parking lots, aircraft ramps, truck and bus storage yards, business parks, residential and public streets.

Catch Basin Filter Competitive Feature Comparison

Evaluation of Catch Basin Filters (Based on flow-comparable units) (Scale 1-10)	Oldcastle Stormwater	Other Insert Filter Types**
Flow Rate	10	7
Removal Efficiency*	80%	45%
Capacity - Sludge & Oil	7	7
Service Life	10	3
Installation - Ease of Handling / Installation	8	6
Ease of Inspections & Maintenance	7	7
Value	10	2

*approximate, based on field sediment removal testing in urban street application **average

Long-Term Value Comparison (Based on flow-comparable units) (Scale 1-10)	Oldcastle Stormwater	Other Insert Filter Types
Unit Value - Initial (\$/cfs treated)	10	4
Installation Value (\$/cfs treated)	10	7
Absorbant replacement (annual avg (\$/cfs treated)	10	2
Materials replacement Value (annual avg (\$/cfs treated)	10	10
Maintenance Value (annual avg (\$/cfs treated)	10	7
Total first yr ROI (\$/cfs treated)	10	5
Total Annual Avg Value (\$/cfs treated, avg over 20 yrs)*	10	5



Combination Inlet



Flat Grated Inlet

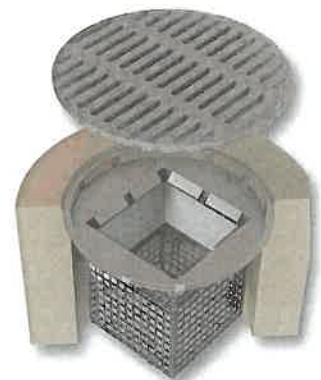

Circular Frame Catch Basin



Captured debris from the Catch Basin Filter, Dana Point, CA



GENERAL SPECIFICATIONS FOR MAINTENANCE OF *FLO-GARD+PLUS*[®] CATCH BASIN INSERT FILTERS

SCOPE:

Federal, State and Local Clean Water Act regulations and those of insurance carriers require that stormwater filtration systems be maintained and serviced on a recurring basis. The intent of the regulations is to ensure that the systems, on a continuing basis, efficiently remove pollutants from stormwater runoff thereby preventing pollution of the nation's water resources. These specifications apply to the FloGard+Plus[®] Catch Basin Insert Filter.

RECOMMENDED FREQUENCY OF SERVICE:

Drainage Protection Systems (DPS) recommends that installed Flo-Gard+Plus[®] Catch Basin Insert Filters be serviced on a recurring basis. Ultimately, the frequency depends on the amount of runoff, pollutant loading and interference from debris (leaves, vegetation, cans, paper, etc.); however, it is recommended that each installation be serviced a minimum of three times per year, with a change of filter medium once per year. DPS technicians are available to do an on-site evaluation, upon request.

RECOMMENDED TIMING OF SERVICE:

DPS guidelines for the timing of service are as follows:

1. For areas with a definite rainy season: Prior to, during and following the rainy season.
2. For areas subject to year-round rainfall: On a recurring basis (at least three times per year).
3. For areas with winter snow and summer rain: Prior to and just after the snow season and during the summer rain season.
4. For installed devices not subject to the elements (washracks, parking garages, etc.): On a recurring basis (no less than three times per years).

SERVICE PROCEDURES:

1. The catch basin grate shall be removed and set to one side. The catch basin shall be visually inspected for defects and possible illegal dumping. If illegal dumping has occurred, the proper authorities and property owner representative shall be notified as soon as practicable.
2. Using an industrial vacuum, the collected materials shall be removed from the liner. (Note: DPS uses a truck-mounted vacuum for servicing Flo-Gard+Plus[®] catch basin inserts.)
3. When all of the collected materials have been removed, the filter medium pouches shall be removed by unsnapping the tether from the D-ring and set to one side. The filter liner, gaskets, stainless steel frame and mounting brackets, etc. shall be inspected for continued serviceability. Minor damage or defects found shall be corrected on-the-spot and a notation made on the Maintenance Record. More extensive deficiencies that affect the efficiency of the filter (torn liner, etc.), if approved by the customer representative, will be corrected and an invoice submitted to the representative along with the Maintenance Record.
4. The filter medium pouches shall be inspected for defects and continued serviceability and replaced as necessary and the pouch tethers re-attached to the liner's D-ring. See below.
5. The grate shall be replaced.

REPLACEMENT AND DISPOSAL OF EXPOSED FILTER MEDIUM AND COLLECTED DEBRIS

The frequency of filter medium pouch exchange will be in accordance with the existing DPS-Customer Maintenance Contract. DPS recommends that the medium be changed at least once per year. During the appropriate service, or if so determined by the service technician during a non-scheduled service, the filter medium pouches will be replaced with new pouches. Once the exposed pouches and debris have been removed, DPS has possession and must dispose of it in accordance with local, state and federal agency requirements.

DPS also has the capability of servicing all manner of catch basin inserts and catch basins without inserts, underground oil/water separators, stormwater interceptors and other such devices. All DPS personnel are highly qualified technicians and are confined space trained and certified. Call us at (888) 950-8826 for further information and assistance.

APPENDIX C

STORM DRAIN STENCILING AND SIGNAGE



Sample Stencil 1